

February 2010

ZEN 2010

**LSM 710, LSM 780,
LSM 710 NLO, LSM 780 NLO and ConfoCor 3
Operating Manual**

Knowledge of this manual is required for the operation of the instrument. Would you therefore please make yourself familiar with the contents of this manual and pay special attention to hints concerning the safe operation of the instrument.

The specifications are subject to change; the manual is not covered by an update service.

- © Unless expressly authorized, forwarding and duplication of this document, and the utilization and communication of its contents are not permitted. Violations will entail an obligation to pay compensation.

All rights reserved in the event of granting of patents or registration of a utility model.

Issued by

Carl Zeiss Microlmaging GmbH

07740 Jena, Germany

Phone: +49 (0) 3641 64 3400

Fax: +49 (0) 3641 64 3144

E-mail: micro@zeiss.de

www.zeiss.de/lsm

How to make best use of the LSM 710, LSM 780, LSM 710 NLO and LSM 780 NLO operating instructions:

This operating manual also includes the instructions for the ConfoCor 3 systems.

A few symbols in these operating instructions will help you to recognize the nature and purpose of information immediately:



The WARNING symbol warns against hazards for the user that might arise when operating the laser.



This WARNING symbol warns against hazards from dangerously high voltages.



The CAUTION symbol warns against faults and hazards that might arise during operation and which might cause damage to the unit.



The NOTE symbol will help you to optimally solve your work problem. It represents a practical tip which will help you to find out which settings and methods are capable of improving or accelerating a procedure.



The HOT SURFACE symbol warns against hazards for the user that might arise when touching the lamp housing during operation.



The MAINS PLUG symbol reminds service personal to pull the mains plug before opening the device housing.

Depending on the request, these operating instructions will supply you with various possibilities:

- If you want to know where to find certain general areas of information, refer to the following outline of sections to get a general overview.
- You will find a detailed table of contents at the start of every chapter. There you will see at a glance what topics are covered in detail.

Always remember: The time you invest in getting acquainted with the product will pay for itself many times over in your application task.

Contents

1 Notes on Device Safety

This section contains general notes on device safety, safe operation, and possible hazards caused by failure to observe the instructions.

2 Setup Requirements

The Setup Requirements section outlines the installation and supply requirements of the LSM 710, LSM 780, LSM 710 NLO, LSM 780 NLO and ConfoCor 3 Microscope Systems, together with the relevant specifications.

3 Introduction to Laser Scanning Microscopy

This section contains the "LSM 710, LSM 780 systems and ConfoCor 3 Quick Guide", the "Confocal Laser Scanning Microcopy Principles", and the "Confocal Laser Scanning Microcopy Methods" brochures.

Here you will find an introduction to Laser Scanning Microscopy, with an explanation of the principles of confocal imaging. The section also outlines the ways to present LSM image series in three dimensions, and introduces you to the performance features of your LSM 710 and LSM 780 systems.

4 System Operation

In this section you will find the most important steps and procedures of the LSM menu structure. The step-by-step description how to get an image will be shown by typical application examples including the WINDOWS VISTA graphic user environment.

5 Macros and Visual Basic

This section contains a description of the use of additional functions, e.g. maintenance, macros.

6 Tools, Additional Software

This section contains a description of the use of optional software packages and the tools for setting the microscope, e.g. "3D for LSM".

7 Annex

The annex contains the Application-specific Configurations, special notes and information for using the LSM microscope.

8 Multiphoton Laser Scanning Microscopy - Using the LSM 710 NLO, LSM 780 NLO

This section provides detailed back ground information on Multiphoton Microscopy including trouble shooting procedures.

9 ConfoCor 3

This section provides background information on Fluorescence Correlation Spectroscopy (FCS) and Photon Counting Imaging

10 Certification

11 Laser Safety Warning Labels

CHAPTER 1 NOTES ON DEVICE SAFETY

CONTENTS

	Page
1	NOTES ON DEVICE SAFETY 2
1.1	General..... 2
1.2	Regulations..... 3
1.3	Power Requirements..... 4
1.4	Physical Dimensions 8
1.5	Environmental Requirements..... 9
1.6	Notes on Setting up the Microscope System..... 9
1.7	Warning and Information Labels 11
1.8	Notes on Handling the Laser Components and Illumination Systems 22
1.9	Notes on Handling the Computer and Data Media..... 25
1.10	Notes on Care, Maintenance and Service 26
1.11	User Interface 28
1.11.1	Mounting and Dismounting Lamps, TPMT and Switching Mirror 28
1.11.2	Mounting and Dismounting the LSM <i>BiG</i> 30
1.11.3	Mounting and Dismounting the Scan Heads 31
1.11.4	Changing the Filter Wheel in the LSM 710 and LSM 780 systems..... 34
1.11.5	Changing Filter Wheels in the ConfoCor 3..... 35
1.11.6	Changing the Filter Modules in the LSM <i>BiG</i> 36
1.11.7	Using External Connectors 37


1 NOTES ON DEVICE SAFETY

1.1 General

The LSM 710, LSM 780, LSM 710 NLO and LSM 780 NLO laser scanning microscopes as well as the ConfoCor 3, including their original accessories and compatible accessories from other manufacturers, may only be used for the purpose of microscopic and spectroscopic techniques.

Laser Scanning Microscopes (LSM) are intended for high resolution imaging of biological or material samples, whereby in contrast to wide field microscopy the specimen is illuminated raster-fashion with a focused laser beam and the optical arrangement prevents light from out-of-focus regions of the specimen contributing to image formation.

The ConfoCor 3 spectroscope is used for fluorescence correlation spectroscopy, whereas the beam is parked in a sample, which might consist of a solution or a cell, fluorescence fluctuations recorded and analyzed by the so-called correlation function.

 Installation and commissioning of the LSM 710 and LSM 780 systems and ConfoCor 3 systems must be performed by authorized Carl Zeiss service staff. The system should not be used prior to instruction by a Carl Zeiss representative.



The manufacturer will not assume liability for any malfunction or damage caused by anything other than the intended use of the LSM 710 and LSM 780 systems or ConfoCor 3 or individual modules or parts of it, nor by any repair or other service operation performed or attempted by persons other than duly authorized service staff. Any such action will invalidate any claim under warranty, including parts not directly affected by such action. This also includes the modification of the system computer with new cards, etc. by the user. The use of a camera at the base port of Axio Observer.Z1 SP stands with motorized beam path switching is not allowed for reasons of laser safety. Any manipulation will result in the loss of warranty of laser safety.

Please read also the notes on device safety and manuals of the microscope, the HBO, the HAL and additional optional devices, if ordered, as the UV Laser, the piezo focusing device, the heating inserts and the Ti:Sa laser.

- As the system is largely operated via menus on a computer, you should be familiar with the principles of the WINDOWS operating system and its graphical user interface. The respective manuals are supplied together with the programs.




The LSM 710 and LSM 780 systems and ConfoCor 3 are devices that belong to laser hazard class 3B. The systems are equipped with safety interlocks that comply with laser hazard class 3B and 4. If equipped with a Ti:Sa laser (see list in section 1.8), the LSM 710 and LSM 780 systems and ConfoCor 3 are devices that belong to laser hazard class 4. WHO recommendations concerning health and industrial protection when handling laser devices must be observed. The operator of the unit must also observe all and any relevant statutory accident prevention regulations. The user is referred to the safety data sheet provided together with the manual.

The LSM 710 and LSM 780 systems and ConfoCor 3 meets the EMC requirements for EN 55011 Class A (intended use in industrial environment). If the LSM is operated in a residential area or in a small trade area other devices may be influenced by conducted or radiated disturbance. In this case special EMC measures are required.

1.2 Regulations

Extensive knowledge of the hardware/the system is indispensable for safe operation of the LSM 710 and LSM 780 systems and ConfoCor 3.

 Read these operating instructions and all device publications belonging to the system conscientiously **before** operating the LSM 710 and LSM 780 systems or the ConfoCor 3! You can obtain additional information on the hardware configuration delivered and on optional system extensions from the manufacturer or via the service hotline.

The LSM 710 and LSM 780 systems and ConfoCor 3 have been designed, built and tested in conformity with the following regulations and guidelines:

- DIN EN 61010-1 (IEC 61010-1) "Safety requirements for electrical equipment for measurement, control and laboratory use", taking relevant CSA and UL specifications into account.
- DIN EN 60825-1 (IEC publication 60825-1) "Safety of laser equipment".
- 21 CFR §1040.10: "Performance Standards for light emitting products – laser products".
- DIN EN 61326: "Electrical equipment for control technology and laboratory use – EMC-requirements",
- Low voltage directive: 2006/95/EG,
- EMC directive: 2004/108/EG.

The company works according to a certified Environment Management System according to ISO 14001.

The Product was developed, tested and produced in accordance with the valid regulations and guidelines for environmental law of the European Union.

The product and its accessories have been classified as instrument category 9 (laboratory equipment or comparable standard). The product and its accessories agree with the EU-regulations 2002/95/EG (RoHS) and 2002/96/EG (WEEE), if applicable for the product.

Carl Zeiss has installed a process for taking back and recycling the instruments within the member states of the European Union, which takes care of the appropriate utilization according to the said EU guidelines.

For details on the disposal and recycling please refer to your relevant Carl Zeiss sales or service organization.

The product must not be disposed in the household waste or through the municipal disposal organizations. In case of resale the seller is obliged to inform the buyer that the product has to be disposed according to the said regulations.

1.3 Power Requirements

The LSM 710 and LSM 780 systems and ConfoCor 3 come with a mains power supply cord and plug, either CEE red (3/N/PE 400/230V/16A), or NEMA L 14-30P (2/N/Ground 120/240V/30A), and with the matching mains socket outlet.

The mains socket outlet must be equipped with a fuse having minimum tripping characteristic C according to IEC/EN 60898.

Line voltage	3/N/PE 400/230 V AC (±10 %)	2/N/Ground 240/120 V AC (±10 %)
Line frequency	50...60 Hz	50...60 Hz
LSM incl. VIS laser:		
Max. current	3 phases at 16 A	2 phases at 25 A
Power	Phase 1 = 1.9 kVA max. Phase 2 = 1.5 kVA max. Phase 3 = 2.6 kVA max.	Phase 1 = 3.2 kVA max. Phase 2 = 2.8 kVA max.
Power consumption	4000 VA max.	4000 VA max.
Class of protection	I	I
Type of protection	IP 20	IP 20
Overvoltage category	II	II
Pollution degree	2	2

- EMC test according to DIN EN 61326-1 (10/2006)
 1. Noise emission according to CISPR 11 / DIN EN 55011 (11/2007)
 2. Noise immunity according to table 2 (industrial sector)

In the rare case of a voltage surge on the power supply line (e.g. from indirect lightning stroke), a momentary interruption of the real time system's functionality is possible. This is no defect. A possible protective means to further minimize the probability of a functional disruption is a transient voltage protector in your facility's power system.

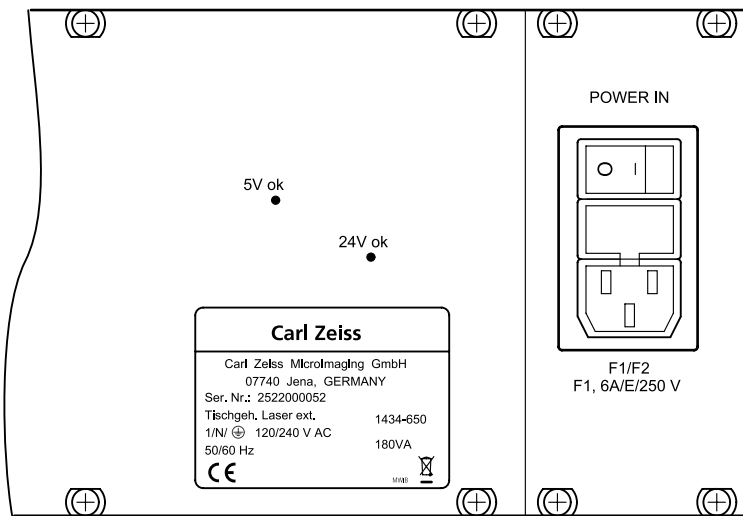


Fig. 1 Fuses F1/F2 of the external laser module

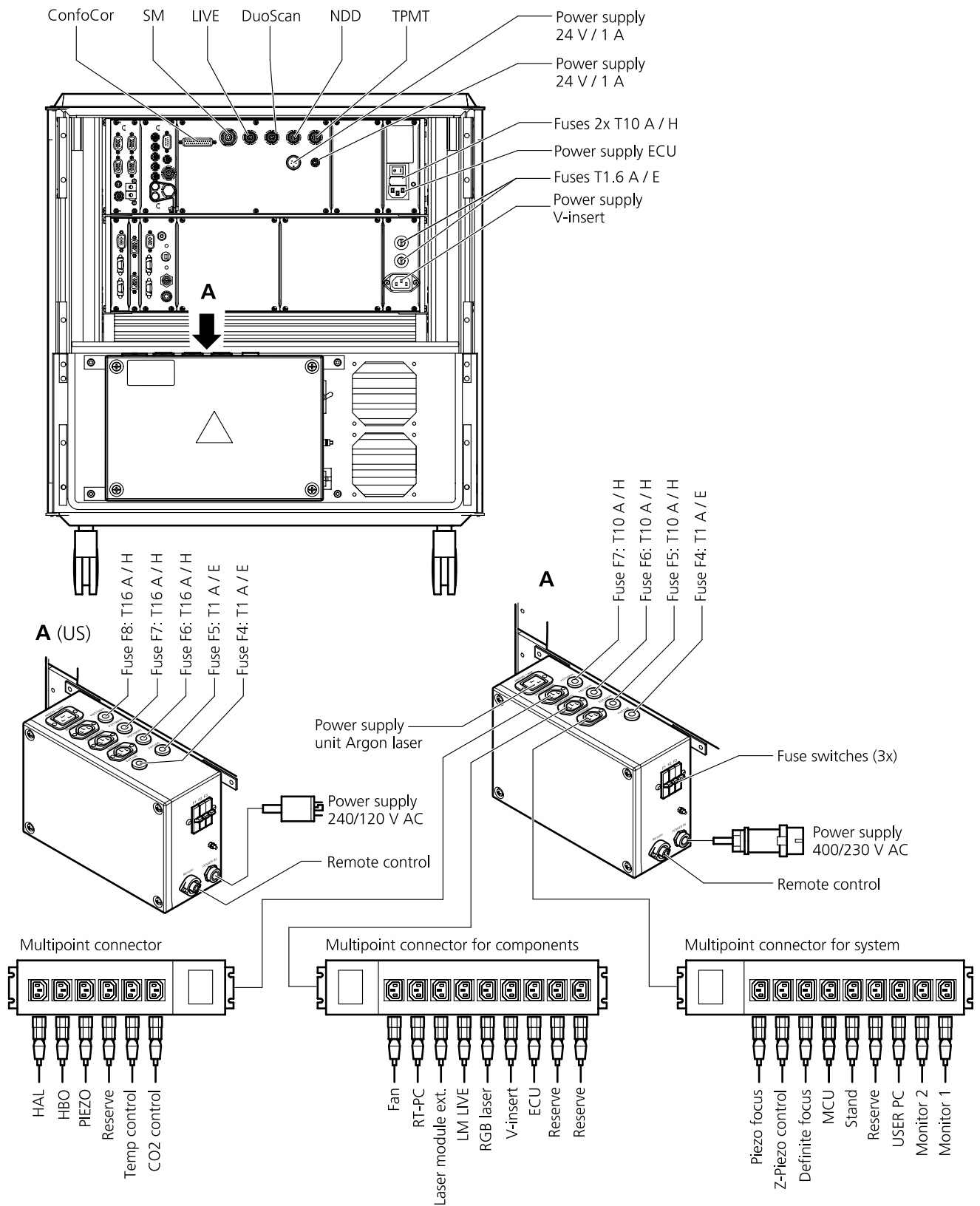


Fig. 2 Power connector for LSM 710 and LSM 780 systems and components. Free/reserve outlets may be used to supply power to additional equipment. No more than 1 A can be provided by each outlet.

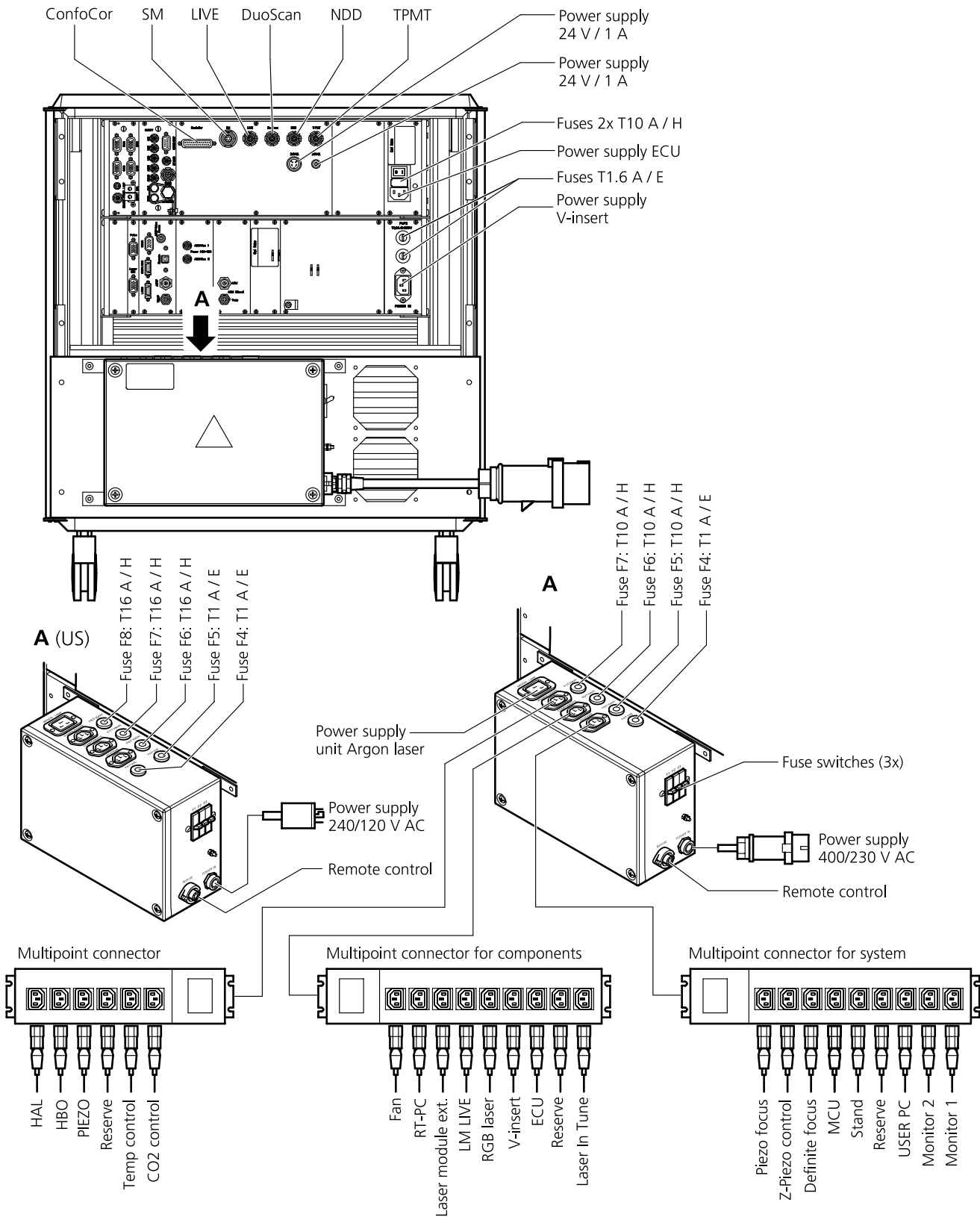


Fig. 3 Power connector for LSM 710 and LSM 780 systems with Laser In Tune and components. Free/reserve outlets may be used to supply power to additional equipment. No more than 1 A can be provided by each outlet.

The door interlock interface (Fig. 4/1) is covered with a green plug to bypass a door interlock.

- To use the interface remove the top of the green plug and the bypass wire.
- Then connect the wires of the door interlock at the same position.

Two door interlocks can be connected.

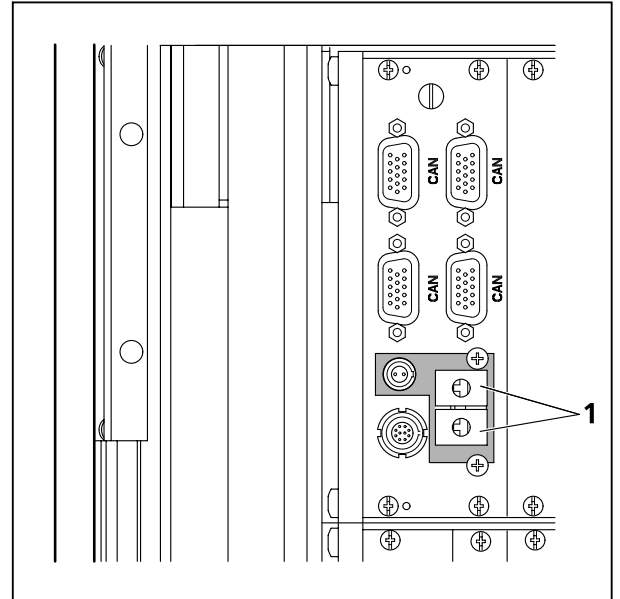
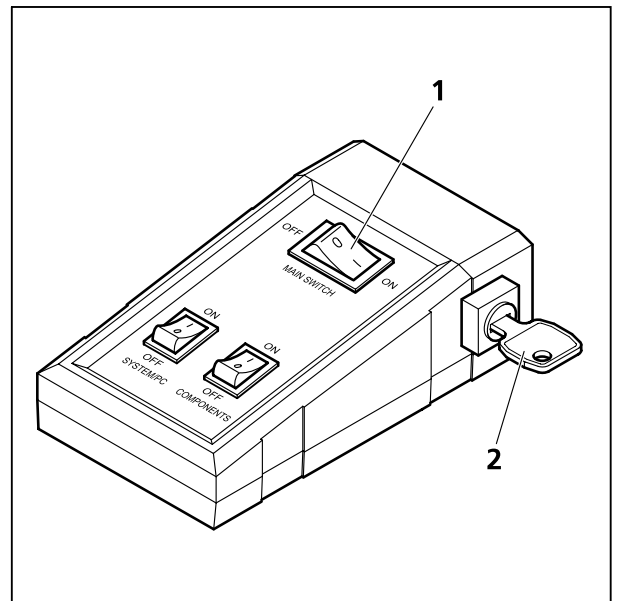


Fig. 4 Door interlock interface (1) on the back of the electronic rack (see Fig. 2 and Fig. 3, top)

The LSM 710 and LSM 780 systems are controlled by a remote control. This remote control contains the main switch for the system and the key switch for the laser.

- To start the system switch the main switch (Fig. 5/1) to ON.
- To activate the laser turn the key switch (Fig. 5/2) to ON position.



- 1 Main switch ON/OFF
- 2 Laser key switch


Fig. 5 Remote control of LSM 710, LSM 780 systems

1.4 Physical Dimensions


	Length (cm)	Width (cm)	Height (cm)	Weight (kg)
Small passively damped system table	90	75	77	80
Small actively damped system table	90	75	77	90
Large actively damped system table	120	90	77	120
Active anti-vibration table (NLO) for Mai Tai Laser or Chameleon	180	150	75	200
Active anti-vibration table (NLO) for two-microscope configuration	250	150	75	400
Scanning Module LSM 710, LSM 780	50	45	22	27
Scanning Module LSM <i>DuoScan</i>	40	15	13	8
Module ConfoCor 3	49	27	18	25
Microscope	50	35	50	20
Electronic Rack with laser units 710	80	60	65	80
Plug-in unit external laser	70	55	25	10
Electronic Rack 7 <i>LIVE</i> / 7 <i>DUO</i>	70	60	65	20
Laser Module <i>LIVE</i>	66	52	22	58
Laser Rack <i>In Tune</i>	80	60	45	40

1.5 Environmental Requirements

1. Operation, specified performance	T = 22 °C ± 3 °C without interruption (24 h a day independently whether system is operated or switched-off)
2. Operation, reduced performance	T = 15 °C to 35 °C, any conditions different from item 1. and 5.
3. Storage, less than 16 h	T = -20 °C to 55 °C
4. Storage, less than 6 h	T = -20 °C to 55 °C
5. Temperature gradient	± 0.5 °C/h
6. Warm up time	1 h, for high-precision and/or long-term measurements ≥ 3 h
7. Relative humidity	< 65 % at 30 °C
8. Operation altitude	max. 2000 m
9. Loss of heat	4 kW

 These requirements do not include the requirements for high precision measurements. Please refer to the Operator's Manual of the microscope for these requirements.

1.6 Notes on Setting up the Microscope System

 Installation and commissioning of the LSM 710 and LSM 780 systems and the ConfoCor 3 systems must be performed by authorized Carl Zeiss service staff. The system should not be used prior to instruction by a Carl Zeiss representative.

The LSM 710, LSM 780, LSM 710 NLO and LSM 780 NLO laser scanning microscopes and the ConfoCor 3 spectroscopy are delivered in several crates.



The LSM 710 and LSM 780 systems and ConfoCor 3 must be set up so as to ensure that the minimum clearance between the wall and the rear of the system is no less than 0.5 m. This clearance is needed for adjustment and maintenance operations.

Do not set up the unit in the proximity of heat sources such as radiators or direct sunlight. To avoid heat build-ups, the ventilation slots on the microscope system must not be covered up.

The system must not be set up in areas with potential danger by explosives.

The unit must be connected to a properly installed socket outlet with earthing contact by means of the mains cables supplied. Continuity of PE connection must not be affected by the use of extension leads.



The system contains components with dangerous voltage. The system must not be opened by anybody else than authorized Carl Zeiss service staff. Before opening the main plug has to be disconnected.



Before connecting the mains cables, please check whether your mains voltage corresponds to the voltage specified on the rating plate of the electrical connection box.



For reasons of laser safety, all ports must either be equipped with the corresponding device (scan head, camera, HBO lamp etc.) or covered with the counterpart of the laser safety kit provided.



Maintenance, repair, modification, removal or exchange of components, or other interference with the equipment beyond the operations described in this manual may only be carried out by the manufacturer Carl Zeiss or by persons expressly authorized by Carl Zeiss to do so.

This applies especially to the microscope system, the laser scanning module, lasers, the PC system, the power supply units, cable connections and other system components.

Please note that the LSM 710 and LSM 780 systems and the ConfoCor 3 are high-precision opto-electronic instruments. Inexpert handling may easily impair their function or even damage them.



The openings for ventilation must not be covered.



There are hot surfaces on the HBO and HAL lamp.



The HBO 50 and 100 W, XBO 75 W and X-cite 120 lamps used on the light microscopes incident light path emit UV light which is harmful to the human eye and skin when observed without appropriate filters. Never remove the lamp and look direct into the emitted light.

After installation or conversion of the LSM system, authorized specialized staff must carefully check that it is in a proper condition and, particularly, that covers protecting against laser radiation are provided.

Tube openings or other unused mounts should always be protected against dust and moisture with the corresponding device components or with termination covers/blind plugs.

By establishing a corresponding workplace environment, please ensure that the formation of electrostatic charges of electronic components is avoided.

To avoid vibrations during operation, the LSM 710 and LSM 780 systems and ConfoCor 3 should only be operated in conjunction with the system table (vibration damping).

 Please note the following for the ConfoCor 3:

- The ConfoCor 3 requires an Axio Observer.Z1 microscope and is attached to channel 4 of the LSM 710 and LSM 780 systems. Note that only system tables with sufficient anti-vibration functionality should be used.
- A scanning stage is recommended for automatic positioning for solution measurements. For cell measurements the scanning mirrors are recommended.

1.7 Warning and Information Labels



The warning and information labels attached on the LSM 710 and LSM 780 systems and ConfoCor 3 must be observed. Check whether all of the labels shown below are provided on your instrument, and contact Carl Zeiss Germany or one of the service agencies if you should discover that any of the labels should be missing. You will receive a free replacement.

Description of labels



Caution:
Faults and hazards that might arise during operation which might cause damage to the unit or injury to the user.



Attention:
Laser radiation hazards possible when operating the system.



Attention:
High voltage.



Pull the mains plug before opening the device housing.



Caution:
Hot surface.



Caution:
UV radiation.



Caution:
Fingers can be caught.



The arrow points to the opening where laser light comes out during operation of the system.



Other labels on the system include one of the above depicted symbols and a detailed description of the handling instructions. See also the following drawings of the system parts.

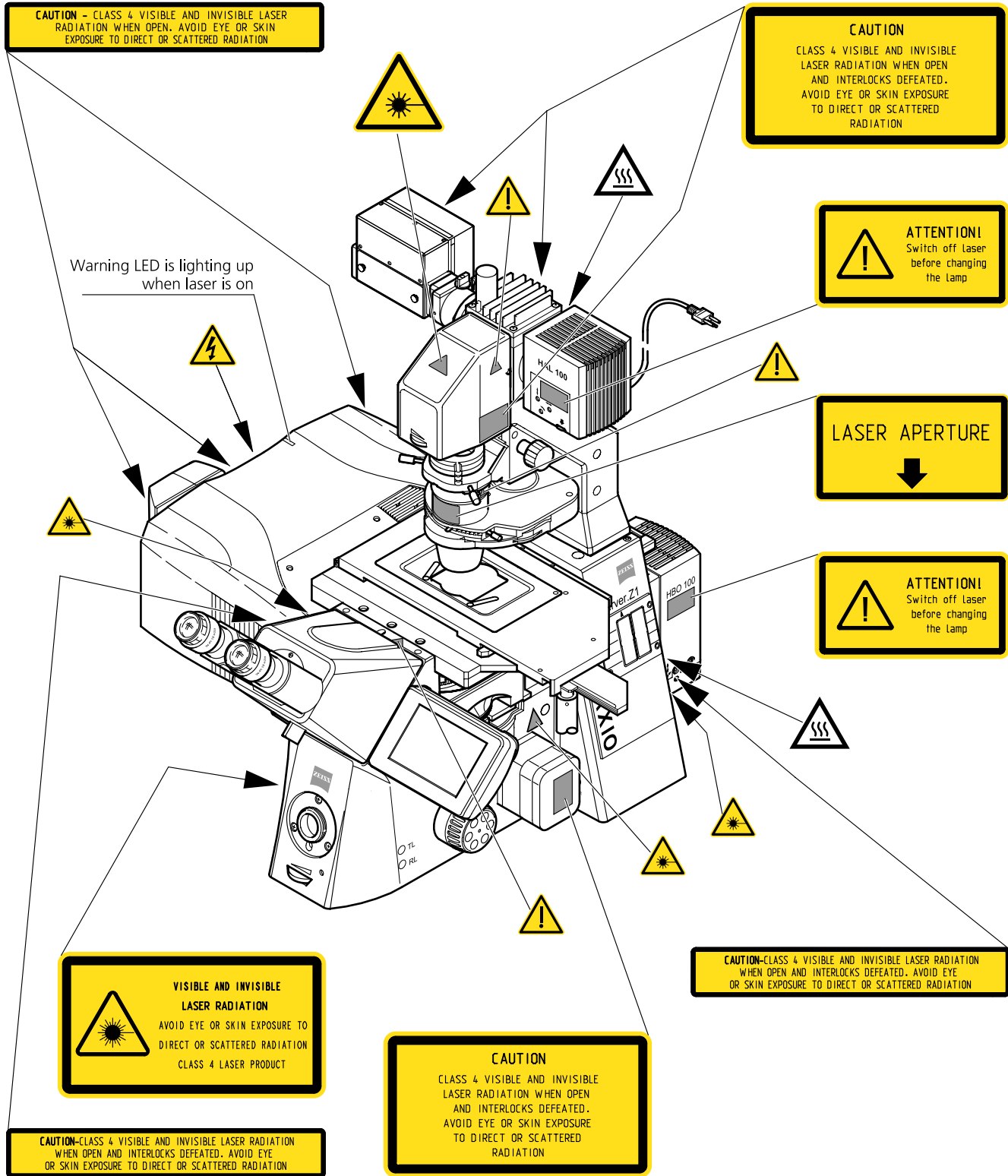


Fig. 6 Warning and information labels on the Axio Observer.Z1 microscope with the LSM 710 / LSM 780 scanning module

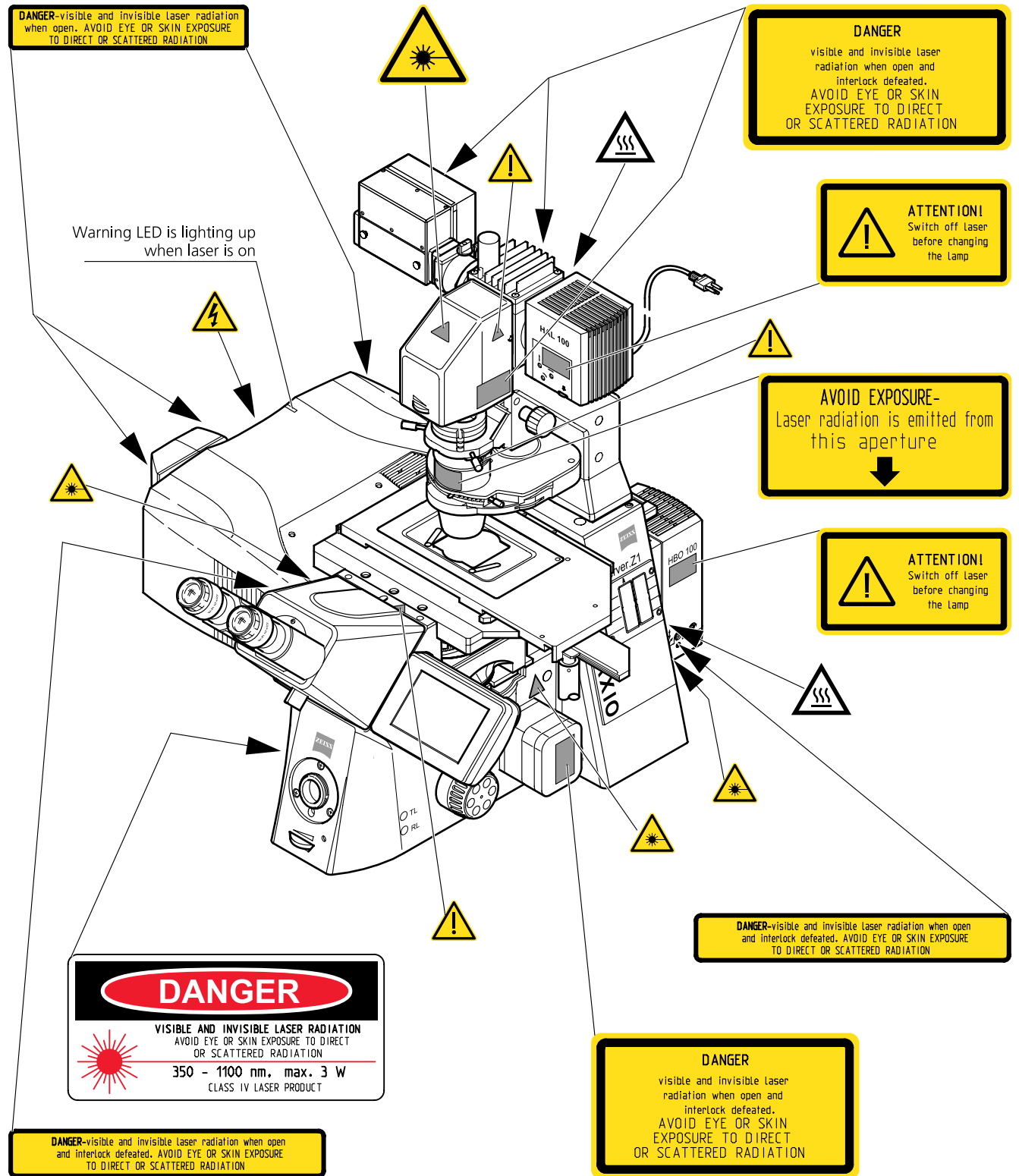


Fig. 7 Warning and information labels on the Axi Observer.Z1 microscope with the LSM 710 / LSM 780 scanning module (US version only)

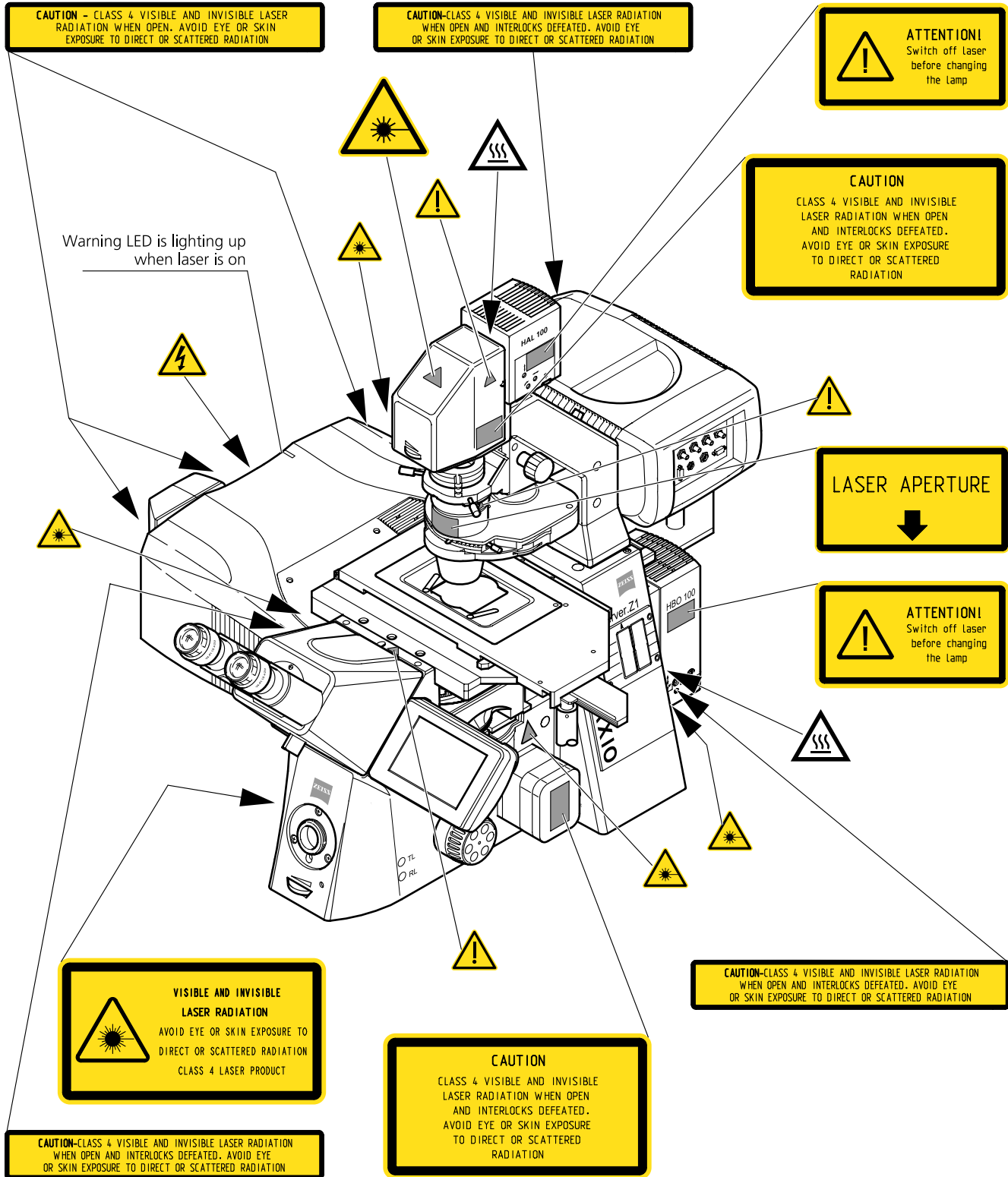


Fig. 8 Warning and information labels on the Axio Observer.Z1 microscope with the LSM 710 and LSM 780 scanning module and the ConfoCor 3 detection module

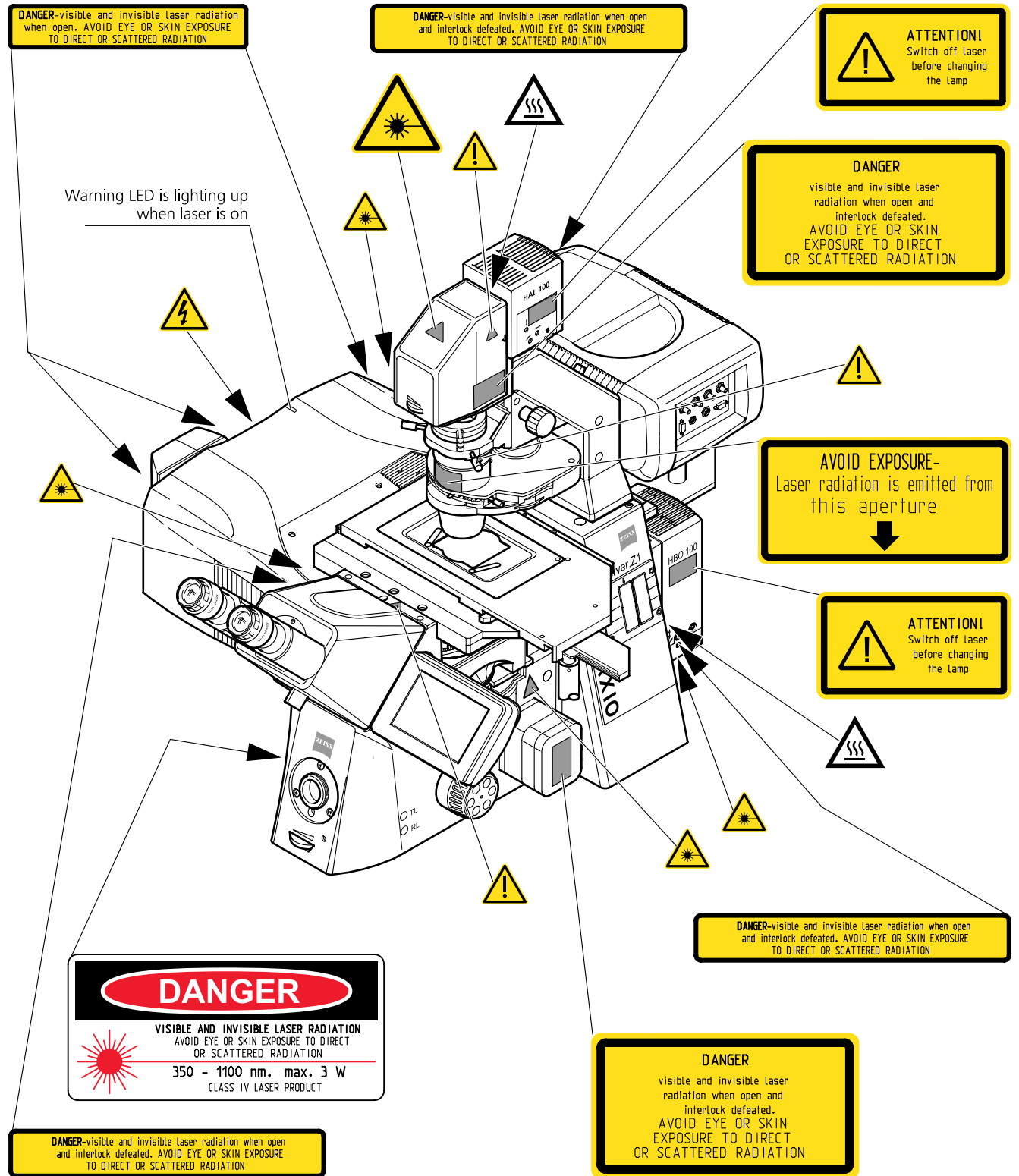


Fig. 9 Warning and information labels on the Axio Observer.Z1 microscope with the LSM 710 / LSM 780 scanning module and the ConfoCor 3 detection module (US version only)

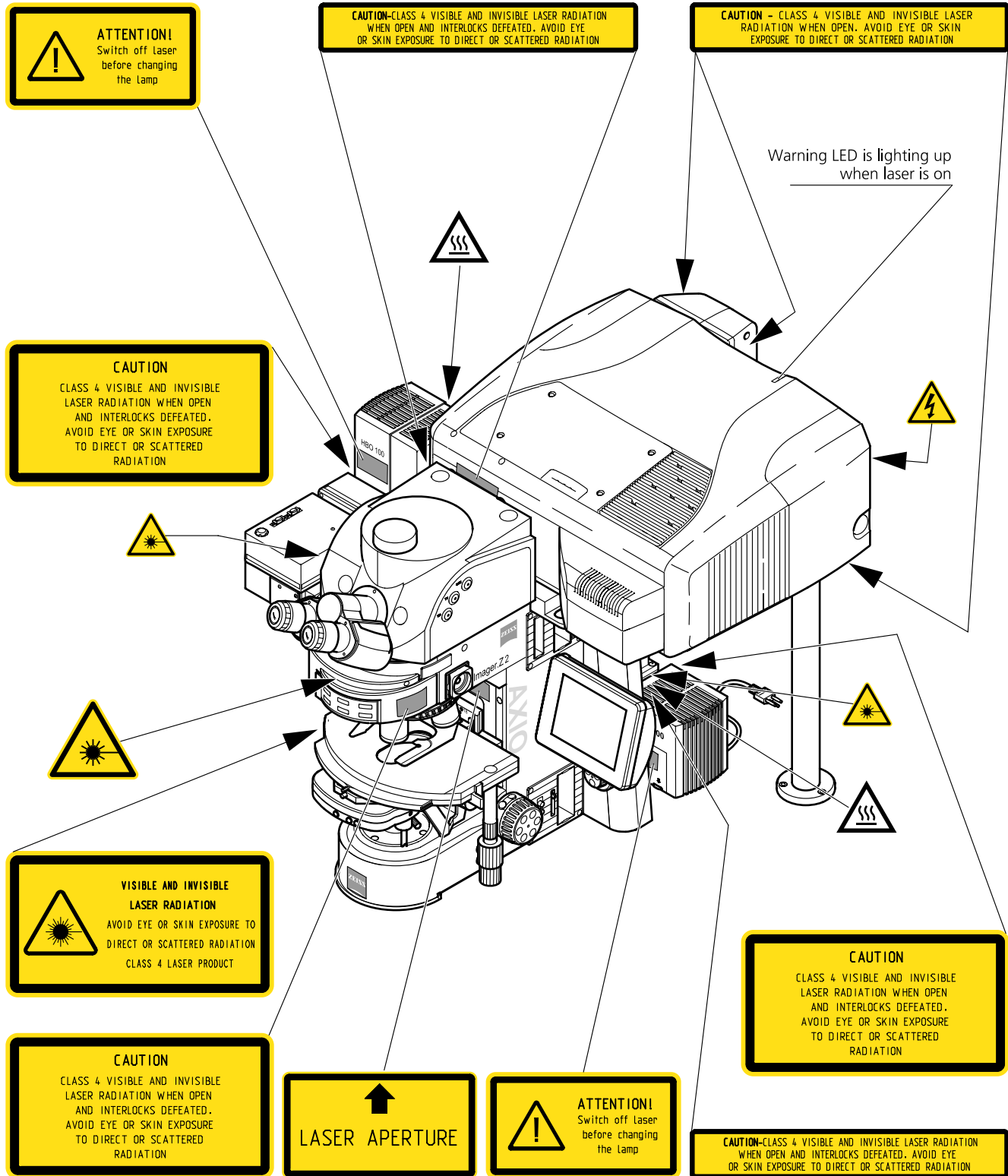


Fig. 10 Warning and information labels on the Axio Imager.Z2 microscope with the LSM 710 / LSM 780 scanning module

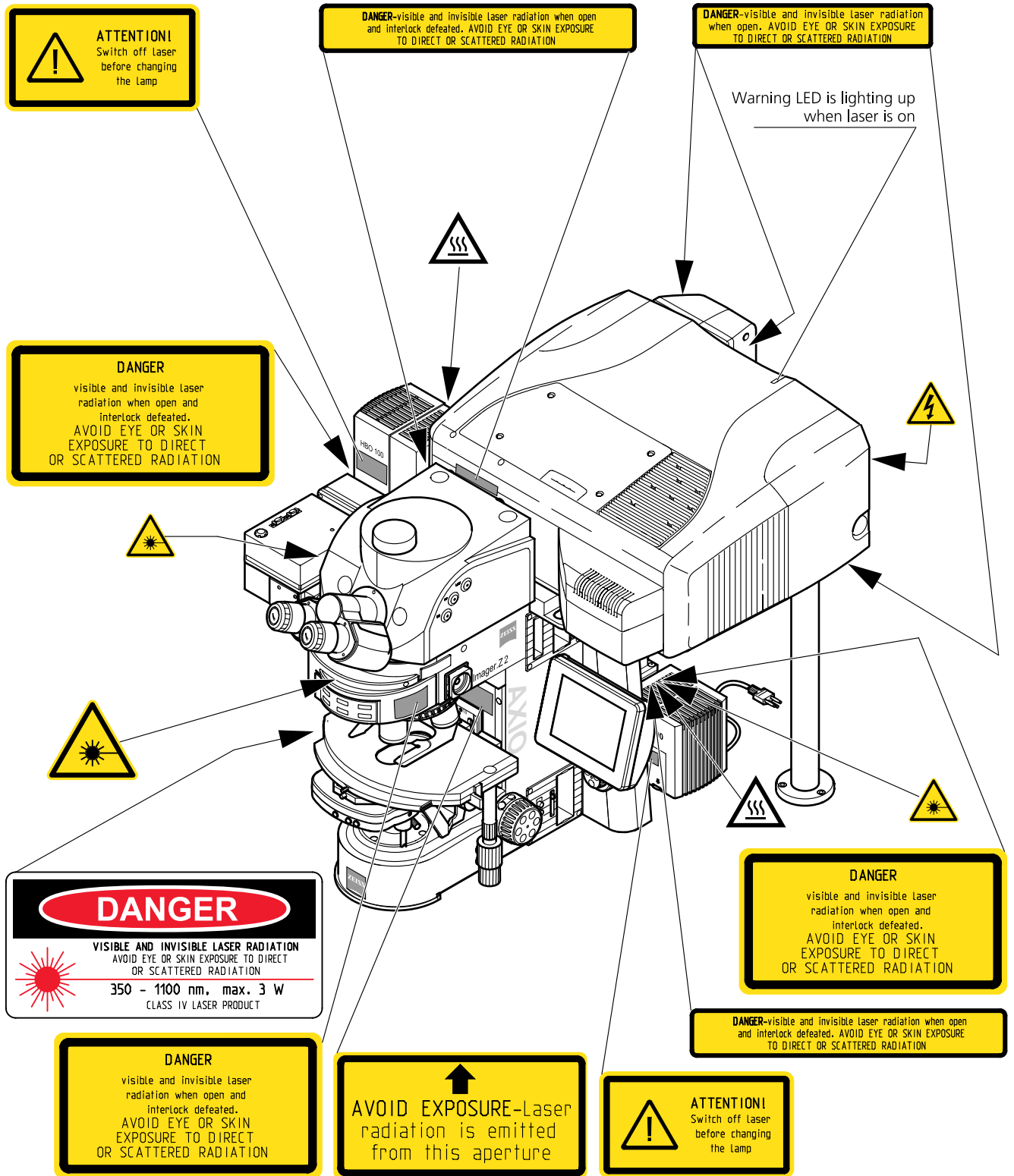


Fig. 11 Warning and information labels on the Axio Imager.Z2 microscope with the LSM 710 / LSM 780 scanning module (US version only)

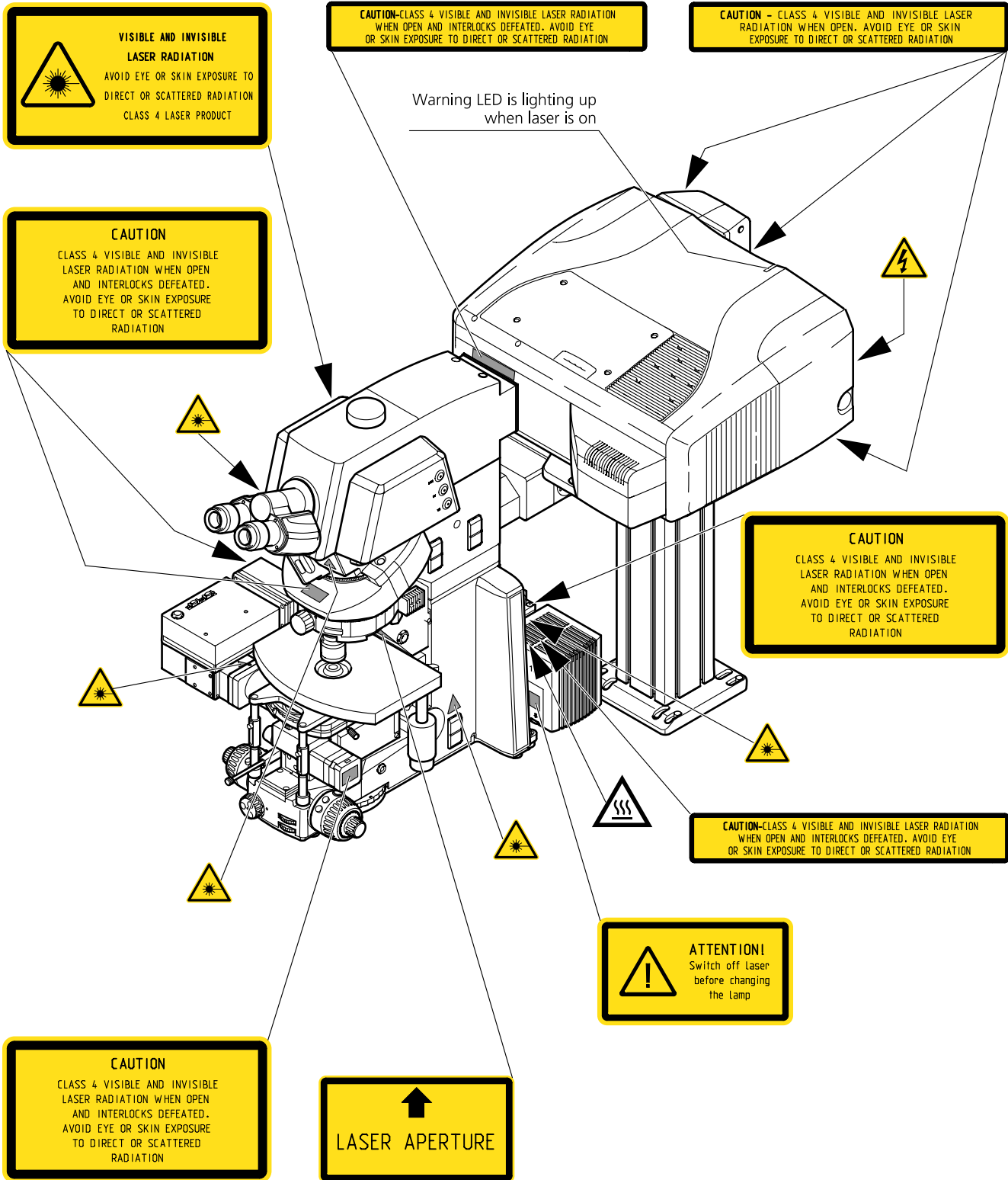


Fig. 12 Warning and information labels on the Axio Examiner microscope with the LSM 710 / LSM 780 scanning module

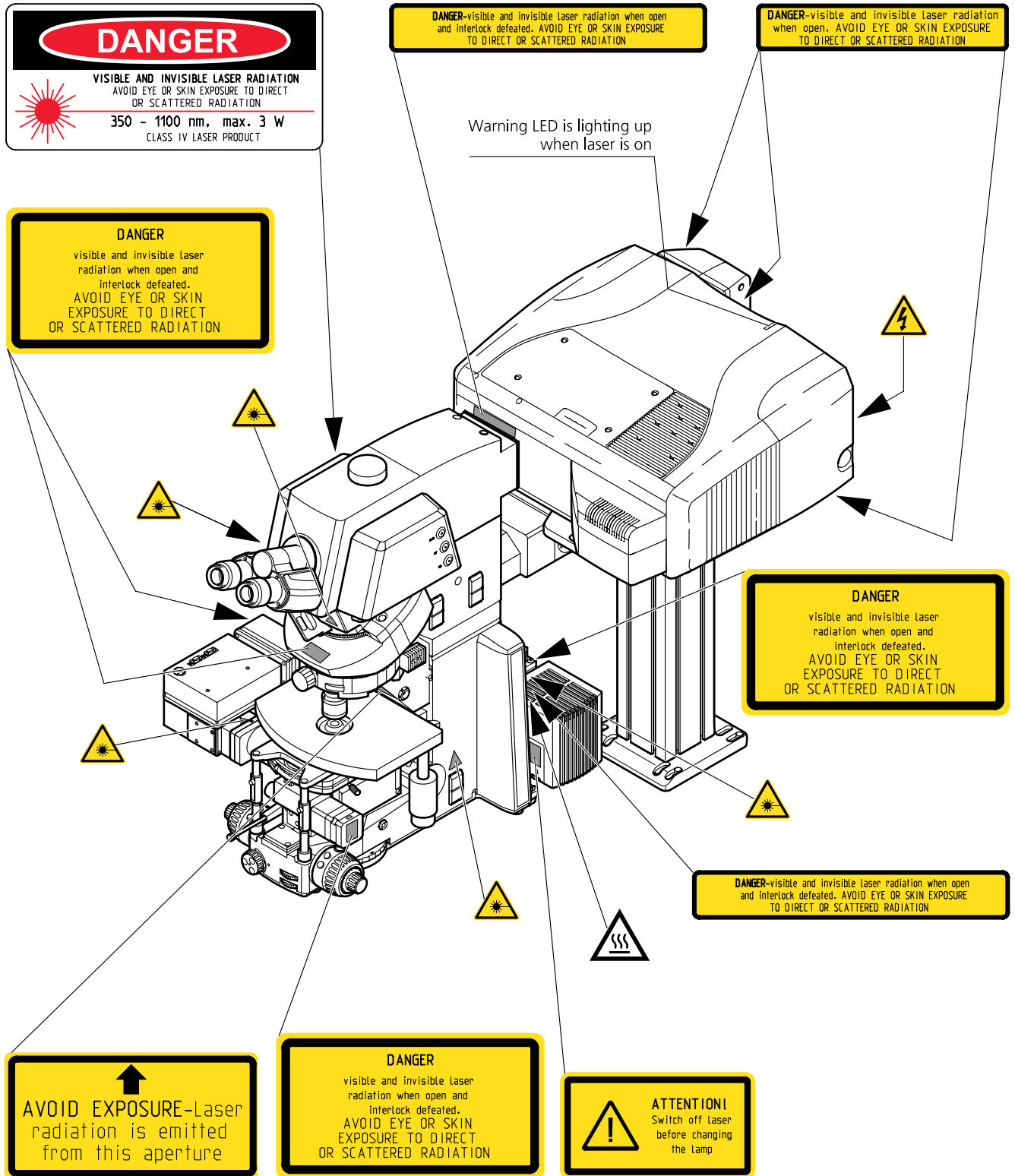


Fig. 13 Warning and information labels on the Axio Examiner microscope with the LSM 710 / LSM 780 scanning module (US version only)

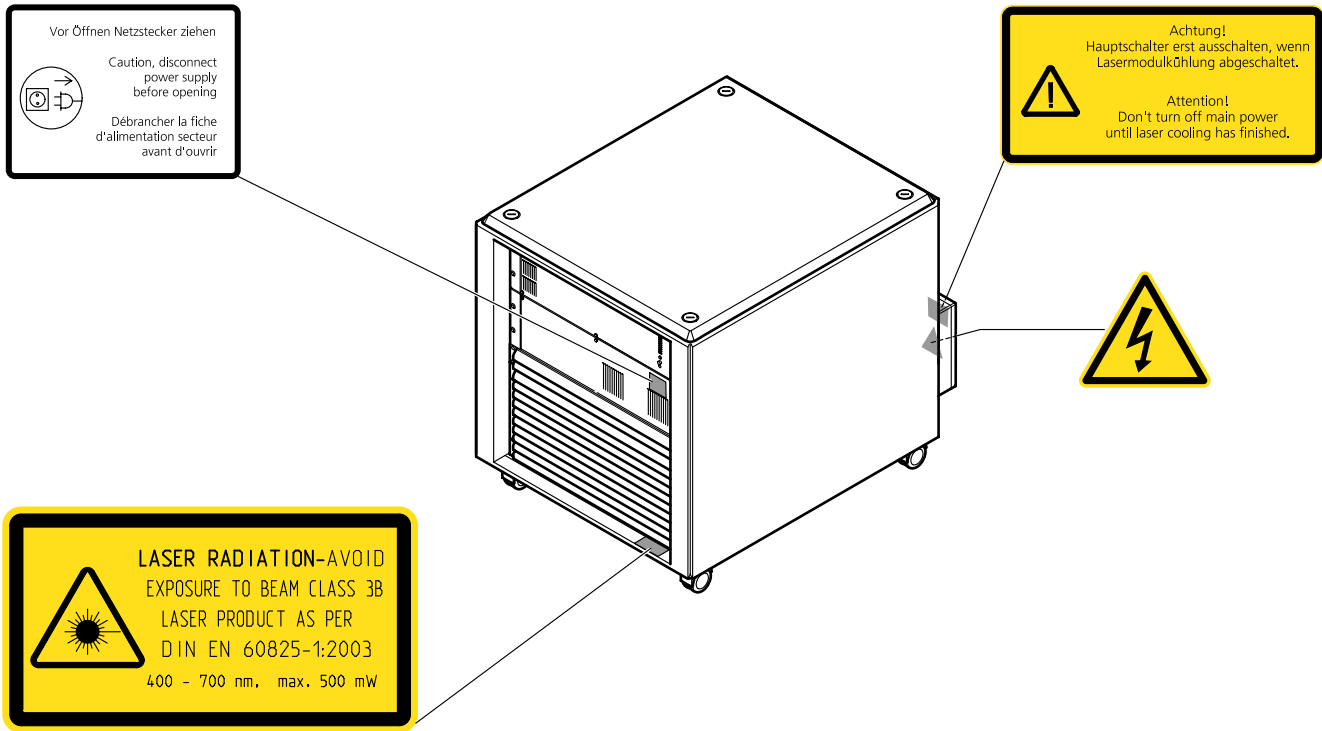


Fig. 14 Warning and information labels on the laser and electronic rack

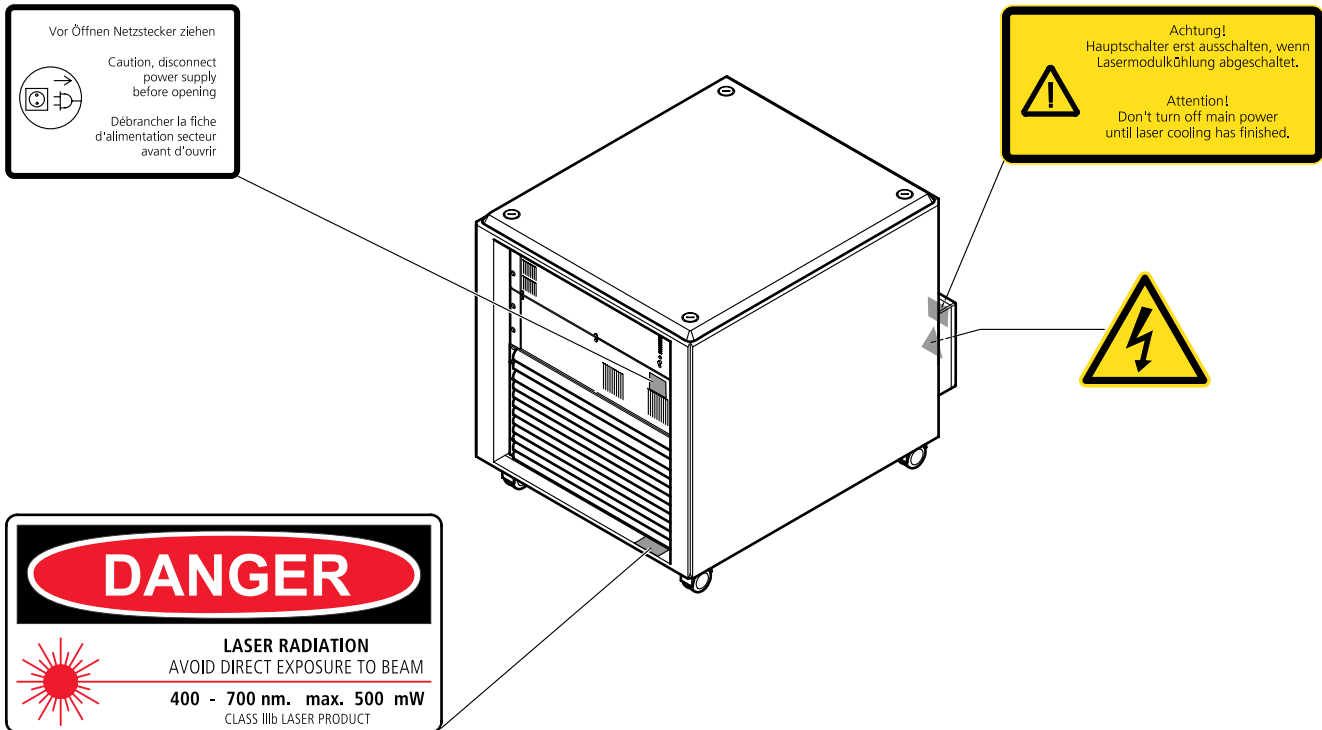


Fig. 15 Warning and information labels on the laser and electronic rack (US version only)

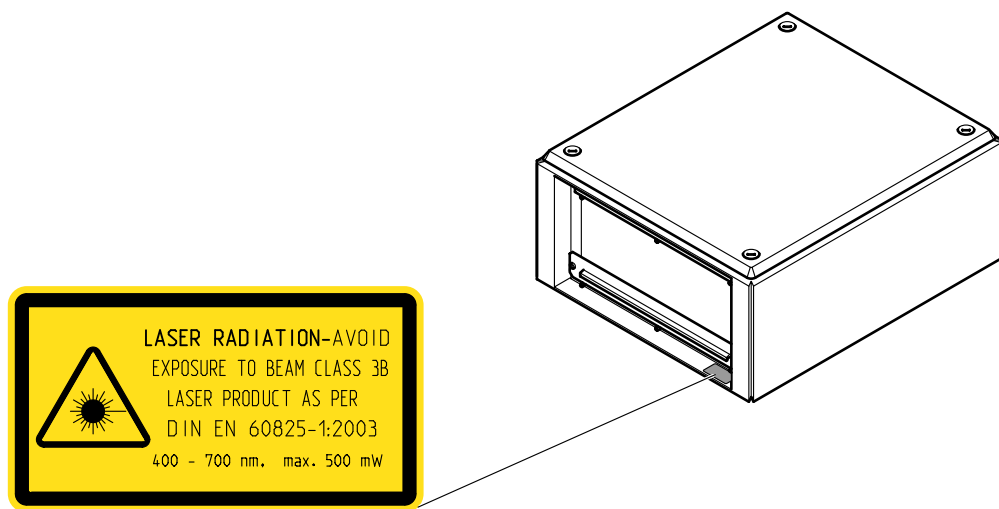


Fig. 16 Warning and information labels on the Laser Rack In *Tune*

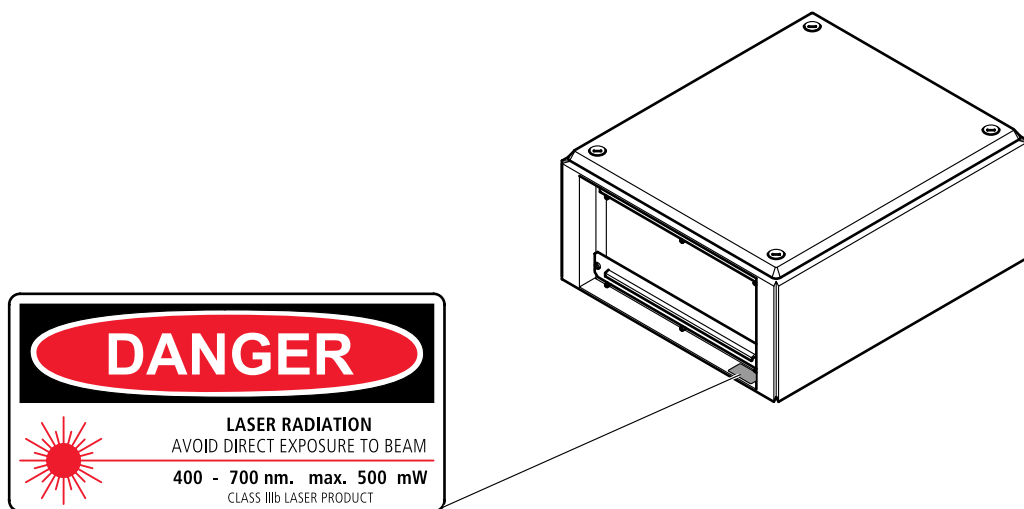


Fig. 17 Warning and information labels on the Laser Rack In *Tune* (US version only)

1.8 Notes on Handling the Laser Components and Illumination Systems



The LSM 710 and LSM 780 systems and ConfoCor 3 are laser hazard class 3B instruments. If equipped with a Ti:Sa Laser, the LSM 710 and LSM 780 systems and ConfoCor 3 are devices that belong to laser hazard class 4. These moderate and high-risk classes embrace medium-power and high power lasers. You must take care not to expose yourself to the radiation of such lasers. In particular, never look into the laser beam! Only personnel which has been instructed on laser safety is allowed to operate the system.



Caution: Use of controls or adjustments or performance of procedures other than those specified herein may result in hazardous radiation exposure.

The following laser types are currently intended for use in the LSM 710 and LSM 780 systems. The use of any other lasers as the ones listed below is not authorized.

Laser	Class	Nominal Power
1 Diode laser 405 nm	3B	30 mW
2 Diode laser ps/cw 405 nm	3B	30 mW
3 Diode laser ps/cw 440 nm	3B	25 mW
4 Ar/ML 458/488/514 nm	3B	25/35 mW
5 HeNe 543 nm	3B	1 mW
6 DPSS 561 nm	3B	20 mW
7 HeNe 594 nm	3B	2 mW
8 HeNe 633 nm	3B	5 mW
9 Ti:Sa Laser Mai Tai (Spectra Physics) 690-1040 nm (depending on the model)	4	min. 3 W
10 Ti:Sa Laser Chameleon (Coherent) 690-1064 nm (depending on the model)	4	min. 3 W
11 Diode laser 405 nm	3B	50 mW
12 Diode laser 440 nm	3B	20 mW
13 OPSS laser 488 nm	3B	100 mW
14 OPSS laser 532 nm	3B	75 mW
15 DPSS laser 561 nm	3B	40 mW
16 Diode laser 635 nm	3B	35 mW
17 Tunable Laser In Tune	3B	min. 1.5 mW*

* Post-fiber average power

 Please contact Carl Zeiss if you intend to use a different laser other than the ones above.

The following table shows the expected laser life times:

Laser wavelength (nm)	Type	Min. power specification for end of life time	Expected life time (in hours)
458/488/514	Laser module LGK 7812 ML5	11.5 mW ¹⁾	> 5000
458/488/514	Laser module LGK 7872 ML8	19.5 mW ¹⁾	> 3000
543	LGK 7786 P with fibre coupling	0.7 mW	> 7000
594	LGK 7512 PF with fibre coupling	1.3 mW	> 10000
633	LGK 7628-1F with fibre coupling	3.1 mW	> 10000
561	FKL module YLK 6120 T	13 mW	> 5000
405	Laser cassette 405 cw	11.5 mW	> 5000
405	Laser cassette 405 cw/ps	11.5 mW ²⁾	> 5000
445	Laser cassette 445 cw/ps	11.5 mW ²⁾	> 5000
488-640	Tunable Laser <i>In Tune</i>	1.35 mW (average power)	> 3000


1) Power specified for single laser lines, life time specified for total power

2) Average power for cw operation

If used properly, the LSM 710 and LSM 780 systems and ConfoCor 3 will not pose any laser radiation risks for operating staff. Nevertheless, you should observe the following warnings:



- If necessary - insofar as specified by law - inform the laser safety officer before commissioning the laser.
- The LSM system and the Ar laser are equipped with a key-interlock.
- Always store keys for laser key switches and, if applicable, keys for further laser power supply units, where they are inaccessible to persons not authorized to operate the laser.
- A laser ON LED on the scan head lights up when laser radiation is emitted.
- Do not place any reflecting objects into the beam path.
- Never open any covers or panels.
- Never look into the laser beam, not even to simply view the specimen, whether with the aid of optical instruments or without. Otherwise you risk going blind!
- Do not leave any empty objective positions of the nosepiece uncovered.
- If a class 4 laser is attached to the system, already stray light can impose danger to the operator.
- With class 4 lasers take special care of fire protection requirements. Do not use or store flammable or explosive solids, fluids or gases in the vicinity of the system.
- Class 4 lasers can inflame also flammable materials like cloth or paper. Do not put such materials into the beam path.
- Do not reach into the process beam inside the sample area whenever the Class 4 laser is active!

 Suitable protective measures must be taken if gases, dust or vapors hazardous to health, secondary radiation or explosive objects should arise on the specimen as a result of laser radiation.




When using a high power broadband illumination (HBO, X-Cite, HXP) in the incident light path in combination with a neutral density reflector module in the microscope stand, there are operating conditions which lead to strong reflections of excitation light into the eyepiece. According to regulations for radiation load the maximal values are below the permissible threshold and do not lead in all probability to any permanent irritation of the eyes also because the natural averting reaction limits the exposure to the bright light. Nevertheless we recommend not to look through the eyepiece when rotating the reflector turret. Especially, we do not recommend the use of the reflector turret controls located on the microscope stand, since this leads to an observation position close to the eyepiece. Instead, use the TFT-Touch screen or the LSM software to switch the reflector turret. In case the reflector turret has to be rotated by hand avoid looking into the eyepiece while doing so.




For NLO systems equipped with a specific push and click filter for NDD imaging be aware that the NDD reflector cube in the reflector turret leads to a strong back reflection of HBO light into the specimen plane and the eyepiece. When observing the specimen through the ocular lens the use of the NDD reflector cube should be avoided. The light flash is not harmful but unpleasant. The reflex of closing the eyelid is sufficiently protective.

1.9 Notes on Handling the Computer and Data Media

The computer used as standard in your LSM system is a high-end workstation Pentium/Xeon computer with WINDOWS VISTA operating system (depending on availability).

 Make sure, though, that you receive your LSM/ConfoCor 3 system with the operating system installed, with initialization and start files set up and with the LSM/ConfoCor 3 program also installed.

 When working with the hard disk, it is important to know that the more data it contains, the slower its operation will become. Therefore, data that you do not need permanently should be stored on other external devices.



When handling diskettes and USB sticks, avoid data losses by protecting them against extreme temperatures, moisture and magnetic fields. The data on a diskette is stored in the form of magnetic signals. To some extent, monitors, telephones or even lamps generate magnetic fields that might destroy this data. Also, never open the metal cover on diskette cases. A diskette's surface can also be destroyed by touching it.



When handling CDs, CD ROMs or DVDs, do not touch the data side of the disc (the side of the disc with no label or printing).

Do not apply paper labels or write on any part of the disc, data side or label side. If dust or fingerprints get on the disc, wipe it with a soft cloth from the center to the edge, but do not use benzine, paint thinner, record cleaner, or static repellent. This can damage the disc.

Do not place the disc in any place where it is exposed to direct sunlight or high temperatures.

Backup your data on a regular basis.

Do not install any other software without talking to your Carl Zeiss representative.



Never turn your computer off before you have terminated the LSM program and run down the WINDOWS VISTA operating system. Otherwise, the program and/or data files may get lost.



The LSM computer is a system computer controlling a high end microscope system. The computer must not be used as a general workstation with frequent updates of windows patches or security patches. The LSM software is released with a specific windows version and patch and this must not be changed unless otherwise released by Carl Zeiss MicroImaging.

1.10 Notes on Care, Maintenance and Service

The manufacturer of the unit cannot be held liable for damage resulting from operating errors, negligence or unauthorized tampering with the device system, particularly as the result of removal or replacement of parts of the unit or as the result of the use of unsuitable accessories from other manufacturers. Any such action will render all warranty claims null and void and also laser safety is no longer warranted.

You are well advised to arrange a service agreement with your nearest Carl Zeiss representative to guarantee perfect functioning of the microscope system in the long term.

Use only original spare parts.

The customer has the possibility to change defective fuses. The positions of the fuses are shown in Fig. 1, Fig. 2 and Fig. 3. The fuses are inserted into fuse holders (normally used for power supply units), bayonet type fuses carriers, slot fuse carriers or screw type fuse carriers. The fuse type is given on the hardware itself and also in Fig. 2 and Fig. 3.

For exchanging fuses proceed as follows:

- Open the fuse carrier by turning 90° clockwise.
- Pull out the fuse carrier and replace the fuse by a new one of the same type.
- Insert the fuse carrier, push it in and lock it by turning 90° anti-clockwise.

Modifications and conversion work on the components of the system must only be carried out by the manufacturer, by the service agency or by persons authorized and trained for this purpose by the manufacturer.

Damaged units or parts may only be repaired or exchanged by the responsible service agency.

During maintenance or repair carried out by the service personnel the customer is requested to stand aside and wear a pair of laser safety goggles if needed.

For exchanging the halogen lamp on stands with HAL 35 W proceed as follows:



Before exchanging the halogen lamp switch off all laser units.



Caution:

Hot surfaces on lamp housing (Fig. 18/1), heat sink (Fig. 18/2) and halogen lamp:
Make sure to let them cool down sufficiently!



Caution:

Do not touch the lamp with your bare hands; if required, clean the lamp using pure alcohol **before** switching the lamp on for the first time in order to prevent contaminations from burning in.

- Switch off the laser and let the halogen lamp cool down for about 15 minutes.

- Unlock the lamp housing (Fig. 18/1) by slightly turning it anticlockwise.
- Remove the halogen lamp with alignment base (Fig. 18/3).
- Remove new 12 V 35 W halogen lamp with adjustment base from the packing box. Insert it in the mount taking care that the tip of the mount engages in the centering notch of carrier plate.
- After replacing the halogen lamp, attach the lamp housing and lock it.

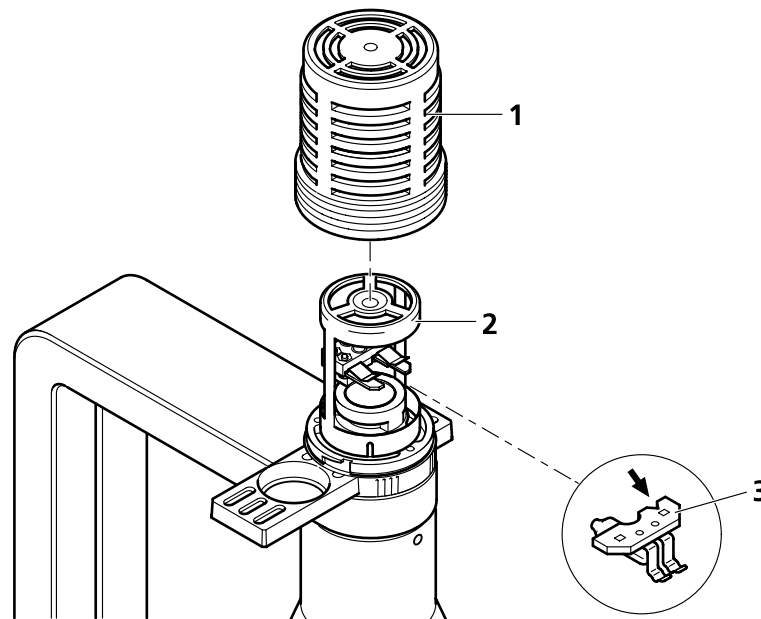


Fig. 18 Replacing the halogen lamp

Care operations that may be carried out by operating staff are limited to cleaning painted and glass surfaces.

- Before cleaning the instrument make sure the main power supply is disconnected.
- Cleaning painted surfaces:
To do this, use a clean cloth that has been moistened in a mixture of water and some detergent; do not use any solvent, however. Dry with a lint-free cloth.
- Cleaning glass surfaces:
Glass surfaces that have become soiled or which are marked with fingerprints may be rubbed with a clean optical cleaning cloth.
If soiling is persistent, dip the optical cleaning cloth into a mixture of distilled water and a small quantity of detergent.
To complete cleaning, lightly breathe on the glass surface and rub it dry with a clean cloth. Lint or dust is best removed with a clean brush.
- Make sure that no cleaning liquid penetrates into the system.

We strongly recommend to get the calibration objective for the objective turret, since the calibration and test tasks in the system maintenance tool (see CHAPTER 6: "TOOLS, ADDITIONAL SOFTWARE") require this tool.

Especially the scanner calibration is recommended every 1-2 years, when the high speeds (13-15) are used frequently.

1.11 User Interface



All user interface ports are equipped with a safety interlock system which warrants laser safety. These interlock devices must not be manipulated. Other interfaces which are not described here are service interfaces and are only to be operated by authorized Carl Zeiss service personnel. The following devices can be mounted and dismantled by the user or are accessible by the user:

- Halogen lamp,
- Transmission PMT,
- Switching Mirror,
- Scan heads,
- NDD's (see CHAPTER 8: "MULTIPHOTON LASER SCANNING MICROSCOPY ..." for details),
- ConfoCor 3 filter wheels (exempt the block filter wheel),
- ConfoCor 3 external connectors,
- LSM 780 / 710 filter wheel

1.11.1 Mounting and Dismounting Lamps, TPMT and Switching Mirror

The ports of the lamps, the switching mirror and the transmission PMT are equipped with hardware interlock devices which have to be operated in the following way:

Interlock with sensor ring and contact ring:

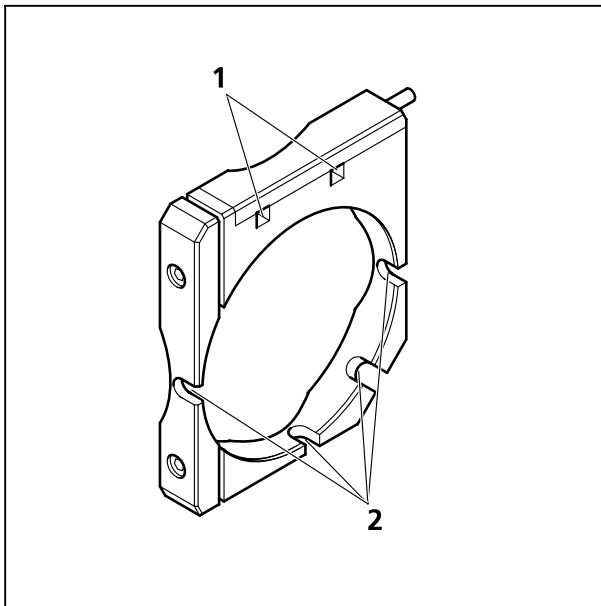


Fig. 19 Sensor ring mounted to the interface ports on the microscope side

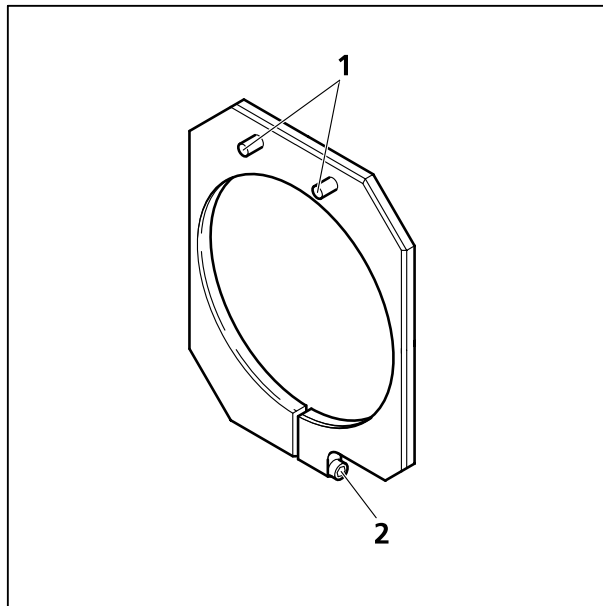



Fig. 20 Contact ring mounted to the lamp, TPMT or switching mirror

The interlock is working when the sensors of the sensor ring (Fig. 19/1) are depressed by the pins on the contact ring (Fig. 20/1). Whenever this is not the case, for example if the distance between the two devices is too large, the laser will be blocked and the system cannot be used.

 In case the system is not operating following the removal or attachment of any device on a port with safety interlock check again the connection of the Contact ring to the Sensor ring.

For dismantling the lamps, TPMT or switching mirror slightly unscrew the contact ring first (Fig. 20/2) so it can be moved away from the sensor ring (Fig. 19). Then unscrew the lamp, TPMT or switching mirror turning the main screw which is in one of the recesses of the sensor ring (Fig. 19). Hold the device to be dismantled with one hand while unscrewing to keep it from dropping. The now empty port has to be closed with the blind cap (Fig. 21) to restore the functionality of the system. Use the main screw of the port to fix the cap. Make sure the pins of the cap depress the sensors of the sensor ring.

 Do not remove the sensor ring from the microscope. This might result in failure of laser safety and a non operating system.

For mounting any lamp, TPMT or the switching mirror back onto the microscope reverse the steps for dismantling the device. Be careful not to bend the pins on the contact ring when screwing the device onto the microscope port.

For the Axio Observer.Z1 transmission port and the two ports available on the motorized switching mirror no sensor ring is present. Instead the sensors are directly installed at the Axio Observer.Z1 transmission port or the two ports of the motorized switching mirror.

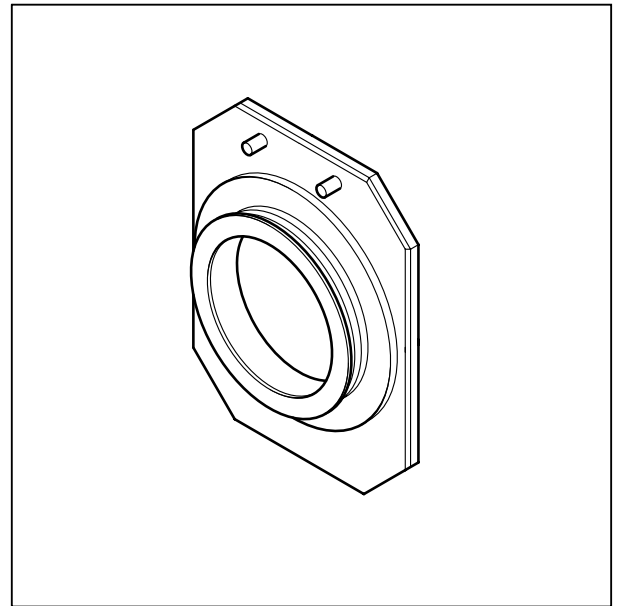


Fig. 21 Blind cap for closing any port equipped with an interlock device

1.11.2 Mounting and Dismounting the LSM *BiG*

⚠ Do not remove the laser safety cable (Fig. 22/1) from the LSM 710 / LSM 780 system. This might result in failure of laser safety and a non operating system.

- Loosen the two fastening screws (Fig. 22/3) of the LSM *BiG* port (Fig. 22/2).
- Slowly pull the LSM *BiG* (Fig. 22/4) away from the port.
- For mounting the LSM *BiG* onto the port, make sure the pins and the electronic connections of the safety interface match closely.
- Push the LSM *BiG* to the port and fasten the two fastening screws.

If the LSM *BiG* is not attached, the laser safety cover must be mounted on the LSM *BiG* port to close the laser safety loop:

- Push the laser safety cover (Fig. 23/3) to the port (Fig. 23/1) and fasten the two fastening screws (Fig. 23/2).

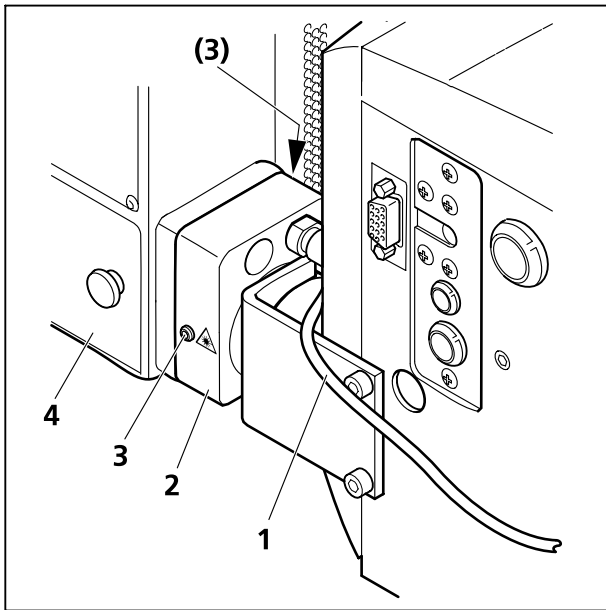


Fig. 22 Port connection between LSM 710 / LSM 780 and LSM *BiG*

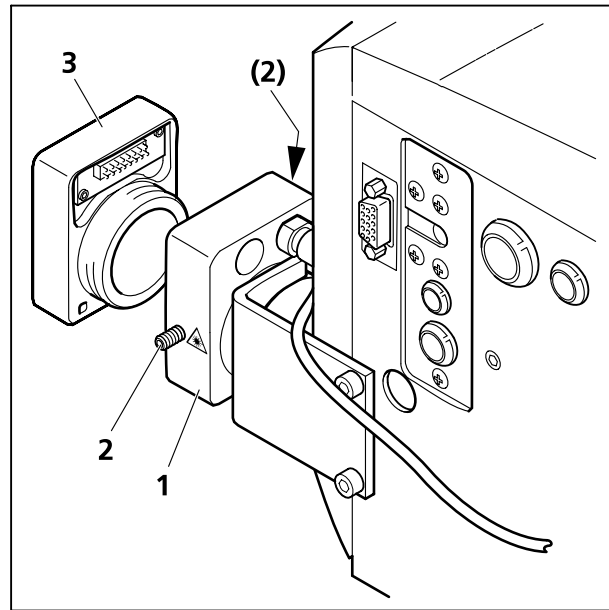



Fig. 23 Laser safety cover for LSM *BiG* port

1.11.3 Mounting and Dismounting the Scan Heads

The scan heads are connected to the microscope via an integrated safety interlock. They can be moved between two microscopes. Make sure the system is shut off completely before starting the following procedure.

 Be aware that the scan head weights up to 28 kg.

- Depending on the microscope stand, it might be necessary to remove the HBO lamp house first before removing the scan head.
- In case of the Axio Imager stand with an angled adapter on the HBO lamp house, the adapter will remain on the stand while the lamp house is removed!

Moving the scan heads between Axio Observer.Z1, Axio Examiner and Axio Imager.Z2:

- Loosen the three fastening screws of the LSM 710 / LSM 780 (Fig. 24/1 and Fig. 25/1).
- Slowly pull the scanning module (Fig. 25/2) away from the microscope port or the tube (Fig. 25/3).
- For mounting the scan head onto a microscope, make sure the pins and the electronic connections of the safety interface match closely.
- Push the scan head to the microscope or the tube.
- Fasten the three fastening screws of the LSM 710 / LSM 780 (Fig. 24/1 and Fig. 25/1).

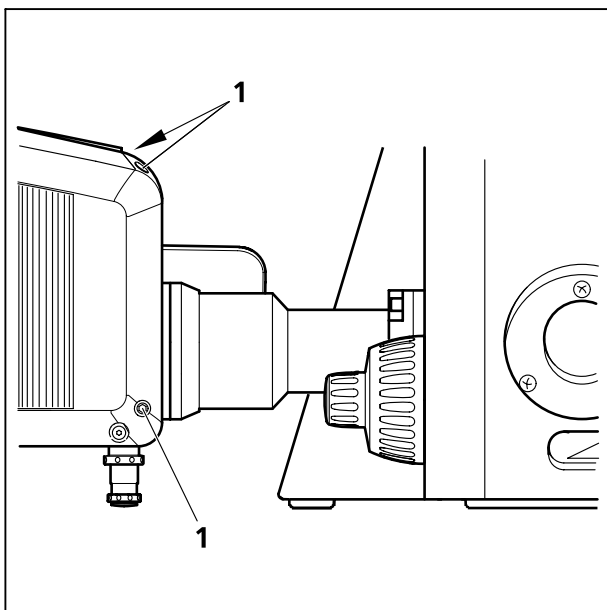


Fig. 24 Port connection between LSM and Axio Observer.Z1

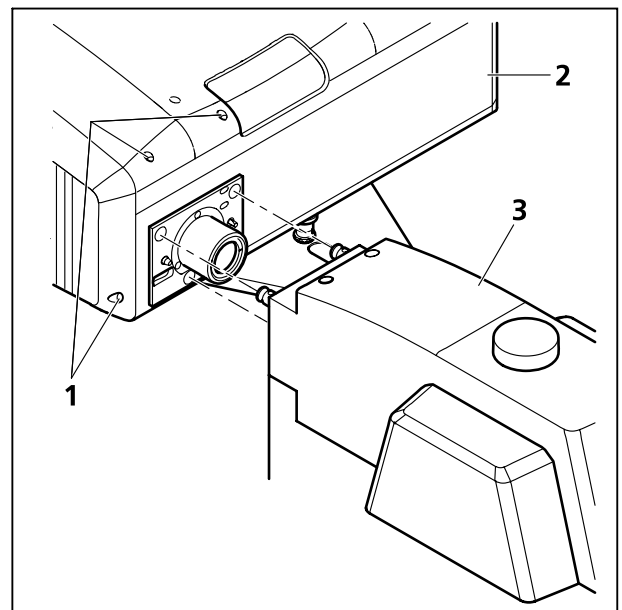


Fig. 25 Port connection between LSM and Axio Examiner or Axio Imager.Z2

For NLO systems which are set up together with a Multiphoton laser, the beam tube connecting the periscope and the scan head, has to be removed before the scan head can be dismantled. Perform the following steps for the removal of the tube:

- First pull out the tube from the periscope cover (Fig. 27/5) by sliding the inner tube into the outer tube (Fig. 27/4).
- Turn the tube assembly counter clockwise to unscrew the tube (Fig. 27/4) from the small black tube (Fig. 27/2) which is fixed to the scan head (Fig. 27/3).
- Now the tube can be removed and you can proceed as described above.
- For rearranging the beam housing, first screw the tube onto the small black tube (Fig. 27/2) at the back of the scan head (Fig. 27/3). It should not be fastened completely to allow the inner tube to fit the side pins into the recess of the ring on the periscope (Fig. 27/5).
- Open the shutter in the periscope using an Allen key (Fig. 26/1) and slide in the tube completely, this will hold the shutter open.

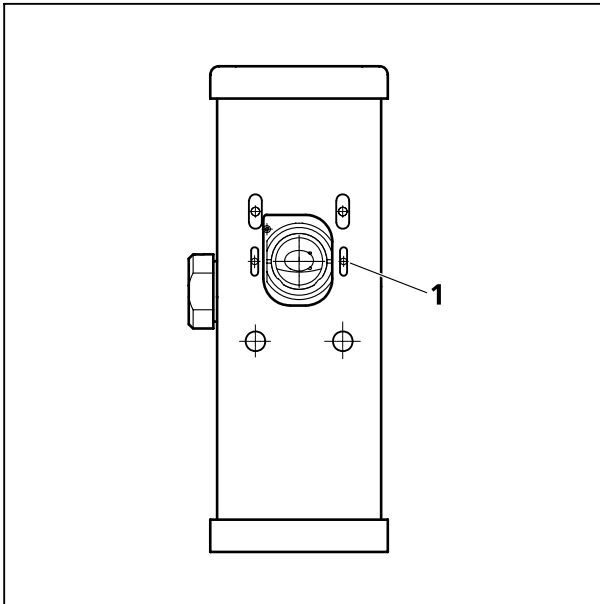


Fig. 26 Shutter opening on the periscope. Also applies for the large periscope for upright microscopes.

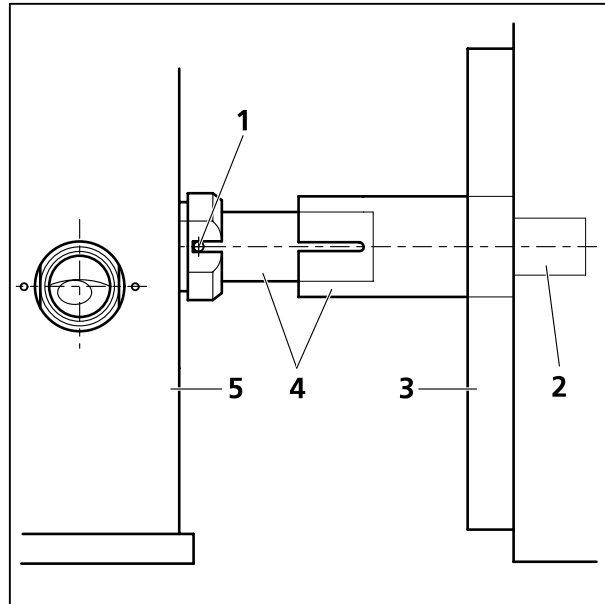


Fig. 27 Tube connection from the periscope housing (5) to the scan head (3). Applies for upright and inverted microscopes.

To ensure functioning of the system and laser safety the following connections have to be changed:

1. The connection of the microscope to the safety interface of the system is located either on the additional Safety Box (Axio Examiner, Fig. 28/1) or on the rear side of the microscope (Axio Imager.Z2 or Axio Observer.Z1; Fig. 29/1 and Fig. 30/1). This connection has to be unplugged from the microscope which is not in use and plugged into the microscope to be used following the exchange of the scan head.

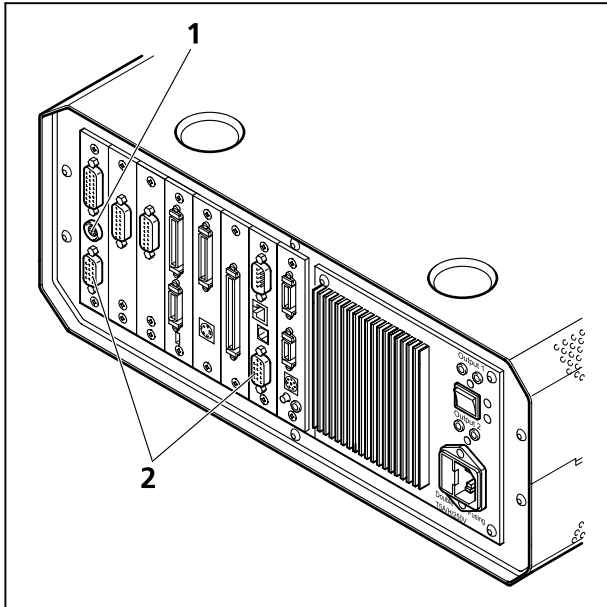


Fig. 28 Electronics Box of Axio Examiner with main connection to safety interface (1) and CAN-connectors (2)

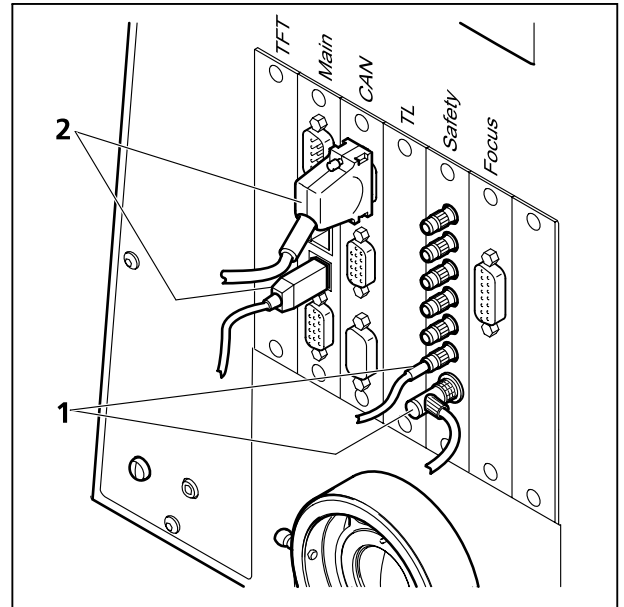


Fig. 29 Connection of Axio Imager.Z2 to safety interface (1) and electronics (2)

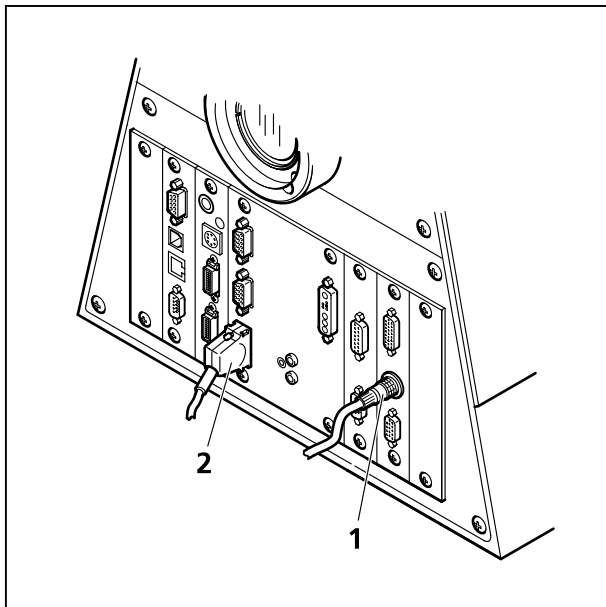


Fig. 30 Connection of Axio Observer.Z1 to safety interface (1) and electronics (2)

2. The CAN connections on the microscopes are shown in Fig. 28/2, Fig. 29/2 and Fig. 30/2. Remove the connection of the microscope no longer in use at the electronics rack and plug in the connection of the microscope which should be used instead.
3. After the connections of the non used microscope are disconnected and the ones of the used microscope are connected, the system can be switched on again. Before initializing the system with the LSM Software make sure to use the right database according to the microscope in use. It can be chosen via the icon **Stand Select**.

1.11.4 Changing the Filter Wheel in the LSM 710 and LSM 780 systems

You can remove and replace filter wheels by push and click.

 When opening the cover, the safety control will switch off the laser light.

To exchange the filter wheel of the LSM 710 and LSM 780 systems proceed as follows:

- Loosen the four fastening screws (Fig. 31/1).
- Remove the cover (Fig. 31/2) of the scanning module.
- Turn the filter wheel (Fig. 32/1) until the free position points upwards. Do not touch the filters!
- Grab the filter wheel on its free position and pull it out upwards.
- Grab the new filter wheel on its free position. Do not touch the filters!
- Insert the new filter wheel and snap it into the holder.
- Close the cover and fasten the four screws.

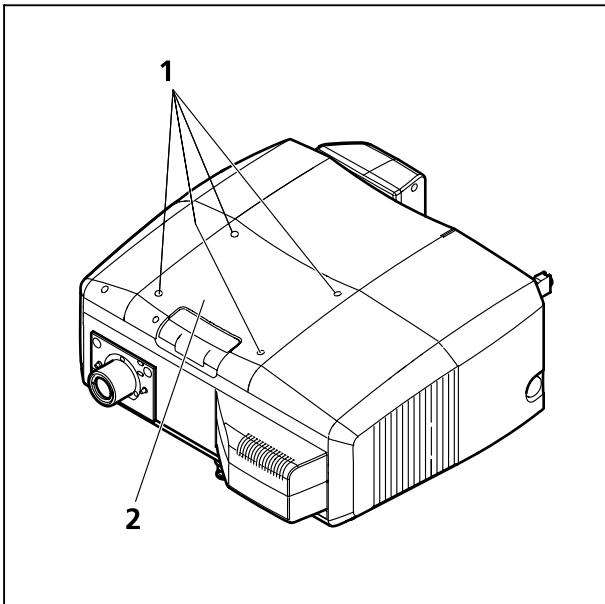


Fig. 31 Removing the cover

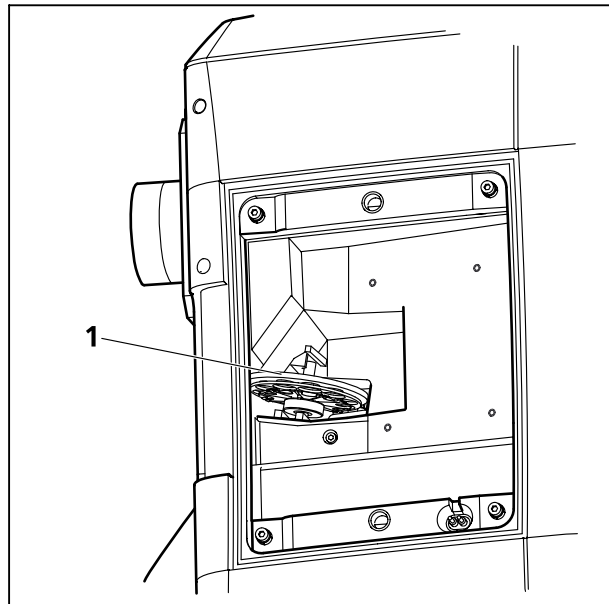


Fig. 32 LSM 710 / LSM 780 filter wheel

1.11.5 Changing Filter Wheels in the ConfoCor 3

By opening the lid (see Fig. 33) you have access to all the filter wheels (exempt the Blocking filter wheel) in the ConfoCor 3.

You can remove and replace filter wheels by push and click.



Be careful not to disrupt any connectors in doing this.



Do not remove the ConfoCor 3 detection head from its attachment to the LSM 710 / LSM 780. Laser light can escape the system through the external port used as the attachment site for the ConfoCor 3 that can lead to bodily damage.



Please note that the data base has to be exchanged if filter wheels are replaced with another filter set.



When opening the lid, the safety control will switch off the laser light.



The BF = block filter can only be exchanged by service.

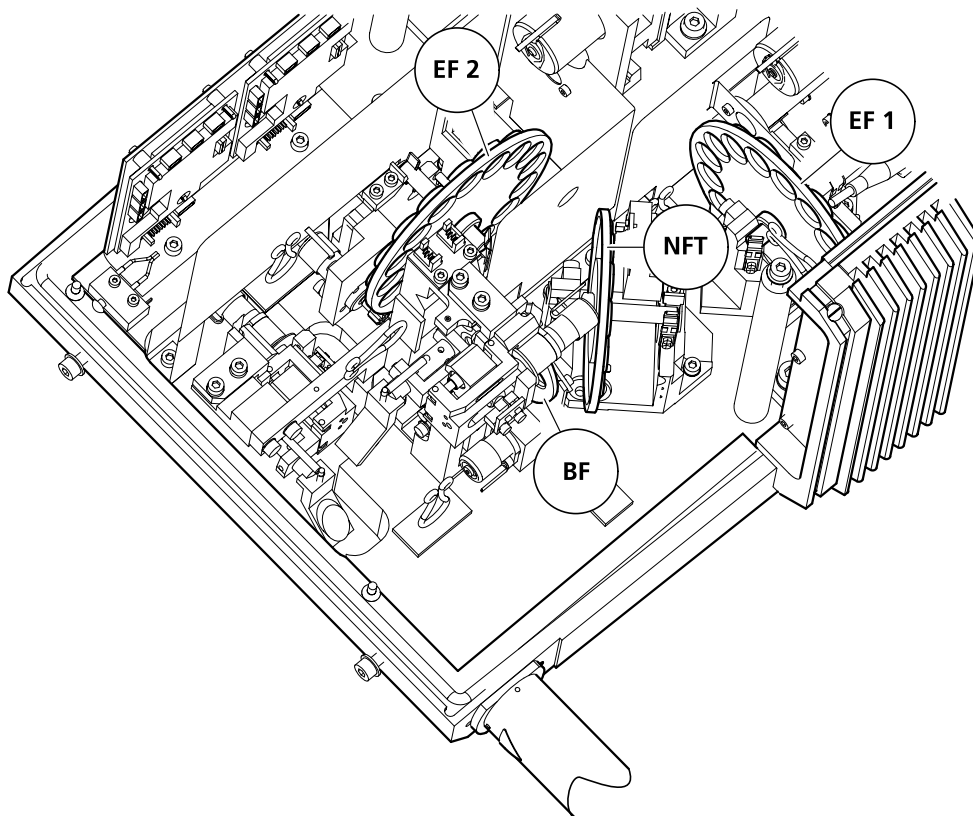


Fig. 33 Top view APD module. The locations of exchangeable filter wheels are indicated (NFT = secondary beam splitter; EF 1 = emission filter 1; EF 2 = emission filter 2).

1.11.6 Changing the Filter Modules in the LSM *BiG*

You can remove and replace filter modules by push and click.

☞ When opening the filter insert, the safety control will switch off the laser light.

To exchange the filter module of the LSM *BiG* proceed as follows:

- Loosen the two knurled screws (Fig. 34/2).
- Remove the filter insert (Fig. 34/3) of the LSM *BiG* (Fig. 34/1) and put it down.

How to uninstall a module:

- Disengage the filter module (Fig. 35/4) from the upper spring elements (Fig. 35/2) of the filter insert (Fig. 35/5) by tilting it forward, then lift it off the lower spring elements (Fig. 35/1) and remove the module.

How to install a module:

- Insert the filter module (Fig. 35/4) with the aid of its mounting elements on its left and right (Fig. 35/3) into the lower spring clips (Fig. 35/1) on the filter insert.
- Press the filter module against the upper spring clips (Fig. 35/2) until it engages firmly.
- After exchanging the filter module, replace the filter insert (Fig. 34/3) into the LSM *BiG* (Fig. 34/1).
- Fasten the two knurled screws (Fig. 34/2).

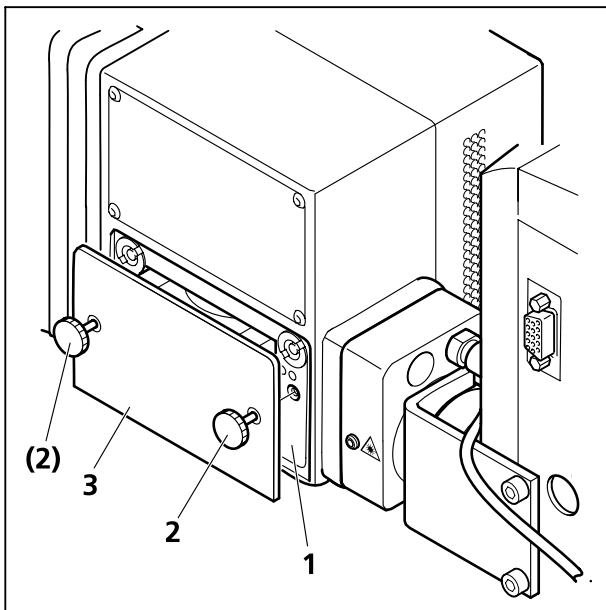


Fig. 34 Filter insert of the LSM *BiG*

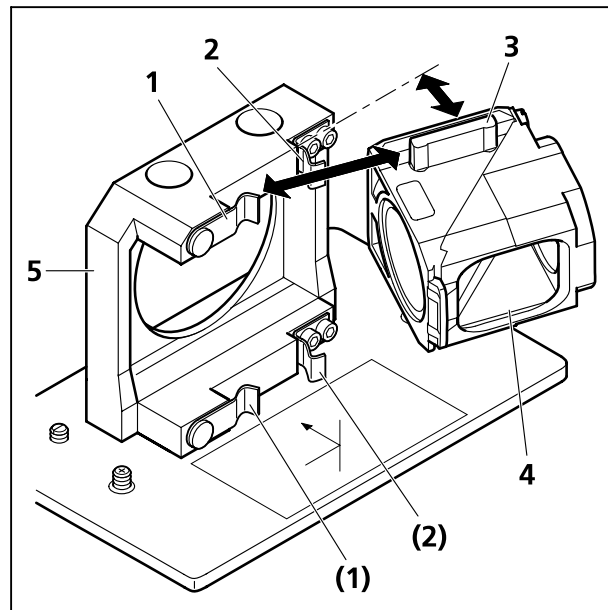



Fig. 35 Changing the filter module

1.11.7 Using External Connectors

In the rear of the APD module, you have external access to the TTL pulses of both channels delivered at the APD 1 and APD 2 plugs (see Fig. 36).

 Please note that the plug is of BNT type and BNT triax cables should be used. If using BNC connectors and coax cables the signal quality can suffer dramatically.

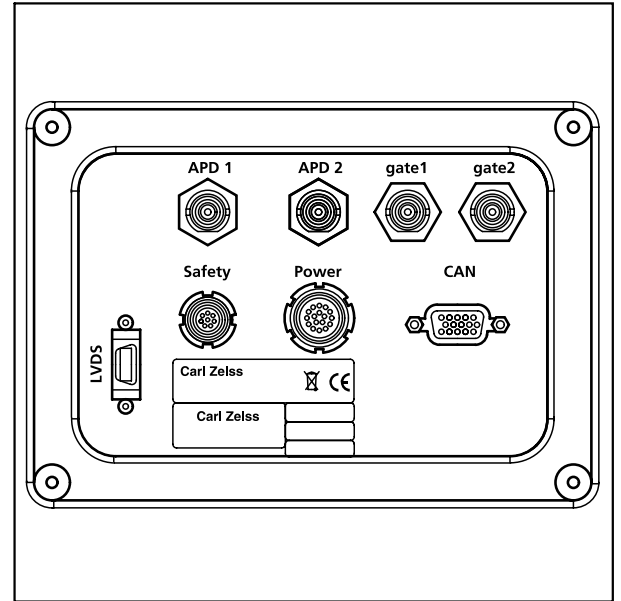


Fig. 36 Rear view APD module

The assignment of the connectors is as follows:

Name	APD	GaAsP (no serial offer)	Meaning
LVDS	14-pin MDR	14-pin MDR	Main communication link
Sub-LVDS		14-pin MDR	Communication to optional module
Safety	8-pin LEMO EXJ-1B	8-pin LEMO EXJ-1B	Laser safety
Power	16-pin LEMO ECJ-2B	16-pin LEMO ECJ-2B	Power consumption: less than 20 W
CAN	15-pin HD Sub-D female	15-pin HD Sub-D female	Optional CAN Port / Service Port
RS232		9-pin Sub-D male	Service Port
APD 1 / 2	Triax BNT		Photon pulse- level: 2.5 V at 50 Ω, 30 nsek long
Gate 1 / 2	Triax BNT		Gate APD- TTL level

To connect the ConfoCor 3 to an optional correlator card, use the connectors APD 1 / 2. As long as the maximum count rate is not reached, each TTL Pulse corresponds to one photon. Take care to use 50 Ω termination to avoid reflections and use double shielded 'triax' cable to avoid heavy distortions of the signal. To connect to BNC equipment, connect inner shield to ground and leave outer shield open.

For gating the APD use TTL signals.

To connect the ConfoCor 3 to an optional FLIM card, use the connectors APD 1 / 2. APD 1 / 2 delivers directly the APD signal (jitter 350 psec) according to the manufacturer's data sheet.

CHAPTER 2 SETUP REQUIREMENTS

CONTENTS

		Page
2	SETUP REQUIREMENTS	2
2.1	Space Requirements.....	2
2.1.1	LSM 710 and LSM 780 on small system table.....	2
2.1.2	LSM 710 and LSM 780 with ConfoCor 3 on large system table	2
2.1.3	LSM 710 and LSM 780 equipped with Two Photon Laser (NLO) for single stand.....	3
2.1.4	LSM 710 and LSM 780 equipped with Two Photon Laser (NLO) for dual stand	3
2.2	Power Requirements.....	4
2.3	Physical Dimensions	5
2.4	Dimension of Shipment Crates.....	6
2.5	Environmental Requirements.....	6
2.6	Vibrations	7
2.7	Microscopes.....	7
2.8	Scanning Module LSM 710, LSM 780, LSM 710 NLO and LSM 780 NLO	8
2.9	Detection Module ConfoCor 3.....	8
2.10	Detection Module LSM <i>BiG</i>	8
2.11	Laser Insert RGB (pigtailed; 458, 488, 514, 543, 561,594, 633 nm).....	9
2.12	Laser Insert V (pigtailed; 405, 440 nm).....	9
2.13	Tunable Laser In <i>Tune</i> 488-640 nm	9
2.14	System Overview LSM 710 and LSM 780.....	10
2.15	System Overview LSM 710 and LSM 780 with ConfoCor 3.....	12

2 SETUP REQUIREMENTS

2.1 Space Requirements

2.1.1 LSM 710 and LSM 780 on small system table

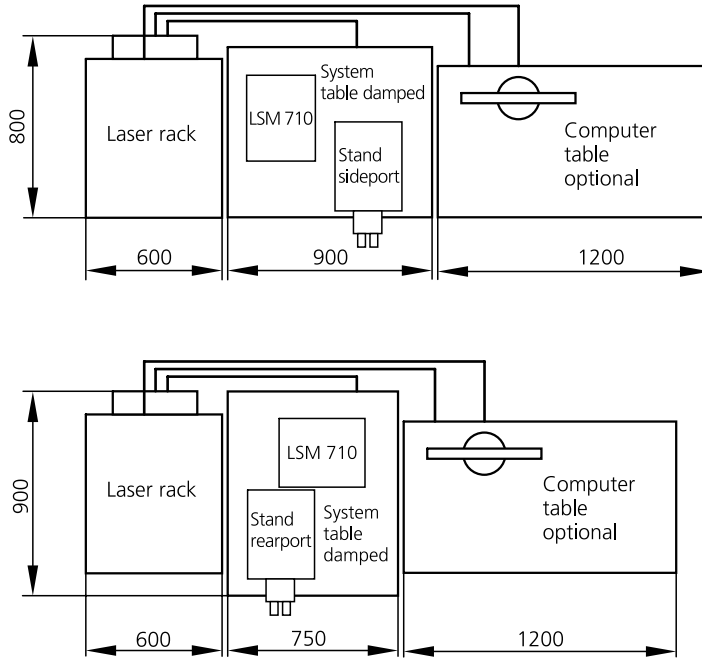



Fig. 1 Space requirements for LSM on small system table (measurements in mm)

 The user PC and the power supply unit for the Ar laser are located beneath the table. If present, the laser Rack *In Tune* is located on top of the Laser Rack of the LSM 710 and LSM 780. The total height of this rack is then 1 m.

2.1.2 LSM 710 and LSM 780 with ConfoCor 3 on large system table

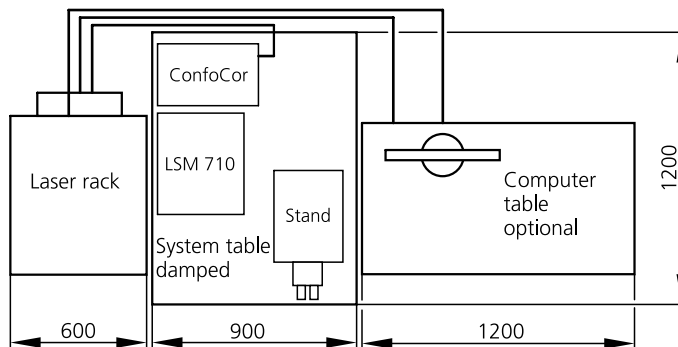



Fig. 2 Space requirements for LSM with ConfoCor 3 on large system table (measurements in mm)

 The user PC and the power supply unit for the Ar laser are located beneath the table. If present, the Laser Rack *In Tune* is located on top of the Laser Rack of the LSM 710 and LSM 780. The total height of these racks is then 1 m.

2.1.3 LSM 710 and LSM 780 equipped with Two Photon Laser (NLO) for single stand

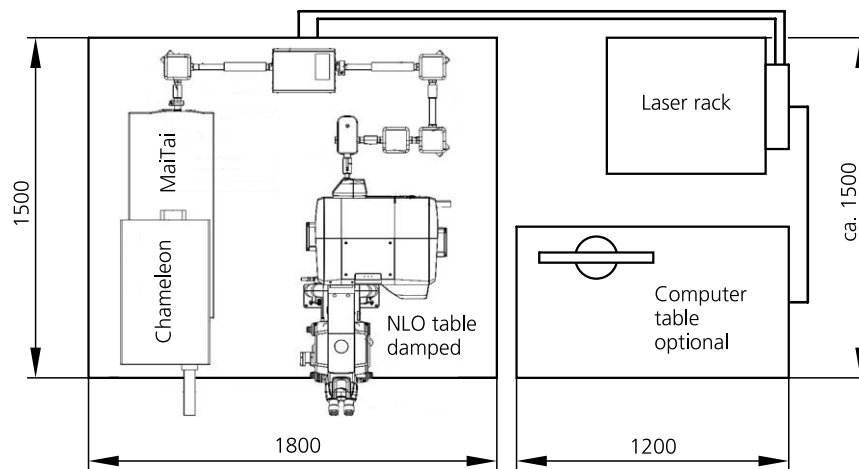


Fig. 3 Space requirements for Two Photon Laser (NLO) single stand (measurements in mm)

☞ The user PC is located beneath the table. If present, the Laser Rack *In Tune* is located on top of the Laser Rack of the LSM 710 and LSM 780. The total height of these racks is then 1 m.

2.1.4 LSM 710 and LSM 780 equipped with Two Photon Laser (NLO) for dual stand

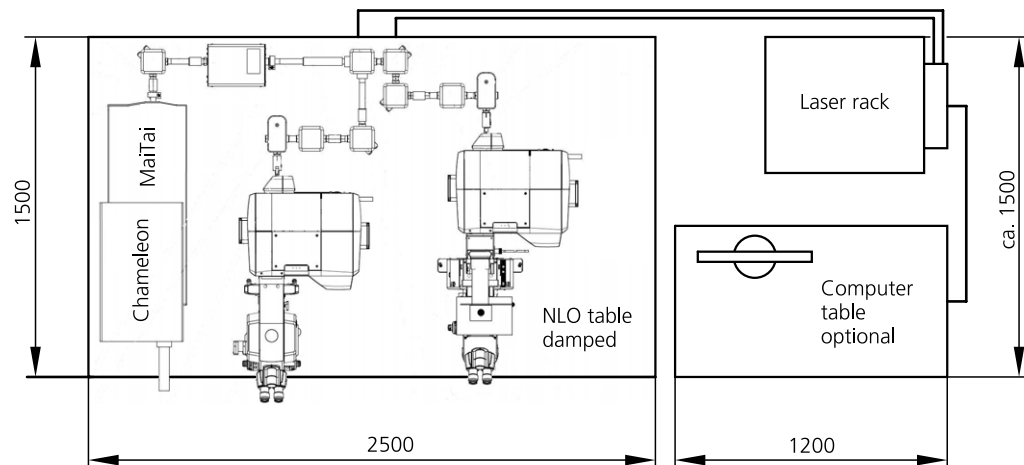



Fig. 4 Space requirements for Two Photon Laser (NLO) dual stand (measurements in mm)


☞ The user PC is located beneath the table. If present, the Laser Rack *In Tune* is located on top of the Laser Rack of the LSM 710 and LSM 780. The total height of these racks is then 1 m.

2.2 Power Requirements

 The LSM 710 and LSM 780 systems and ConfoCor 3 come with a mains power supply cord and plug, either CEE red (3/N/PE 400/230V/16A), or NEMA L 14-30P (2/N/Ground 120/240V/30A), and with the matching mains socket outlet.

The mains socket outlet must be equipped with a fuse having minimum tripping characteristic C according to IEC/EN 60898.

Line voltage	3/N/PE 400/230 V AC ($\pm 10\%$)	2/N/Ground 240/120 V AC ($\pm 10\%$)
Line frequency	50...60 Hz	50...60 Hz
LSM incl. VIS laser:		
Max. current	3 phases at 16 A	2 phases at 25 A
Power	Phase 1 = 1.9 kVA max. Phase 2 = 1.5 kVA max. Phase 3 = 2.6 kVA max.	Phase 1 = 3.2 kVA max. Phase 2 = 2.8 kVA max.
Power consumption	4000 VA max.	4000 VA max.
Class of protection	I	I
Type of protection	IP 20	IP 20
Overvoltage category	II	II
Pollution degree	2	2

 EMC test according to DIN EN 61326-1 (10/2006)
1. Noise emission according to CISPR 11 / DIN EN 55011 (11/2007)
2. Noise immunity according to table 2 (industrial sector)

2.3 Physical Dimensions

	Length (cm)	Width (cm)	Height (cm)	Weight (kg)
Small passively damped system table	90	75	77	80
Small actively damped system table	90	75	77	90
Large actively damped system table	120	90	77	120
Active anti-vibration table (NLO) for Mai Tai Laser or Chameleon	180	150	75	200
Active anti-vibration table (NLO) for two-microscope configuration	250	150	75	400
Scanning Module LSM 710 / LSM 780	50	45	22	28
Module ConfoCor 3	49	27	18	25
Microscope	50	35	50	20
Electronic Rack with laser units LSM 710 / LSM 780	80	60	65	80
Plug-in unit external laser	70	55	25	10
Laser Rack In <i>Tune</i>	80	60	65	40
Fiber optic cable, In <i>Tune</i>	200			
Fiber optic cable, VIS(ible)	250*			
Fiber optic cables at NLO systems	250*			
Cables	250*			

* On request: 350 cm

2.4 Dimension of Shipment Crates

Crate containing	Length (cm)	Width (cm)	Height (cm)	Weight (kg)
Large system table	130	100	92	130
Small system table	100	85	92	100
Active anti-vibration table (NLO) for Mai Tai Laser or Chameleon	190	160	90	350
Active anti-vibration table (NLO) for two-microscope configuration	260	160	90	480
Laser Rack and LSM 710 / LSM 780	104	94	144	130
Accessories (large box)	139	94	114	150
Accessories (small box)	112	94	96	100
Microscope stand (max. size)	96	89	94	50
Laser Rack In Tune (without laser)	104	94	72	10
Laser In Tune	74	60	40	30

2.5 Environmental Requirements

1. Operation, specified performance	T = 22 °C ± 3 °C without interruption (24 h a day independently whether system is operated or switched-off)
2. Operation, reduced performance	T = 15 °C to 35 °C, any conditions different from item 1. and 5.
3. Storage, less than 16 h	T = -20 °C to 55 °C
4. Storage, less than 6 h	T = -20 °C to 55 °C
5. Temperature gradient	± 0.5 °C/h
6. Warm up time	1 h, for high-precision and/or long-term measurements ≥ 3 h
7. Relative humidity	< 65 % at 30 °C
8. Operation altitude	max. 2000 m
9. Loss of heat	4 kW

2.6 Vibrations

Vibrations under operation conditions (with system table)	Shipping shock (LSM 710 / LSM 780 box)
5 µm pp at 5 Hz 10 µm pp at 10 Hz 10 µm pp at 20 Hz	10 g

2.7 Microscopes

Inverted Axio Observer.Z1 with side port or rear port
 Upright Axio Examiner with LSM-tube or rear port
 Upright Axio Imager.Z2 with LSM-tube or rear port
 Upright Axio Imager.M2p with LSM-tube
 All IC²S objectives from Carl Zeiss and their accessories can be accommodated.

Z motor DC servomotor, opto-electronically coded
 Least Z interval: 25 nm (Axio Observer.Z1 SP or RP)
 30 nm (Axio Examiner)
 10 nm (Axio Imager.Z2)
 25 nm (Axio Imager.M2p)
 measured according to VDI 3441

Piezo Objective focus Piezo-driven single objective drive
 Max. travel 250 µm; resolution 15 nm

Z-Piezo stage Piezo driven stage insert for scanning stages
 Max. travel 250 µm; resolution 5 nm

In the unlikely case of extreme fluctuations of the external power net or electromagnetic radiation, the piezo crystal will vary and disturbance in the image is visible. Note that this is not a defect and the piezo drive will not be damaged.

2.8 Scanning Module LSM 710, LSM 780, LSM 710 NLO and LSM 780 NLO

Scanners	2 individually driven galvanometric scanners
Scanning speed	Up to 8 frames/sec (512 × 512 pixels)
Field resolution	Max. 6144 × 6144 pixels (individually adjustable for each axis)
Field of view	11.3 × 11.3 mm ² with a 1.25× objective (20 mm diagonal in intermediate image)
Zoom	0.6× ... 40×, continuous control (Axio Examiner 0.67x to 40x)
Channels	a) Up to 3 confocal fluorescence channels (PMT) simultaneously or b) 34 confocal fluorescence channels (PMT-array) simultaneously or c) 32 GaAsP + 2 PMT fluorescence channels simultaneously (LSM 780)
	1 transmitted light channel (PMT) and up to 5 NDD channels or 2 - 10 NDD channels (Non descanned detectors, PMT) 2 monitor diodes for maintenance purposes Direct adaptation of external detectors
Dynamic range	16-bit DAC for each detection channel
Pinholes	1 pre-adjusted master-pinhole, individually adjustable for Multitracking and short wavelengths (i. e. 405 nm) Computer controlled automatic alignment

2.9 Detection Module ConfoCor 3

Channels	2 channels with APD detectors
Dynamic range	12-bit DAC for each detection channel
Pinholes	1 individual pinhole (channel 4 of LSM 710, LSM 780, LSM 710 NLO and LSM 780 NLO) Computer controlled automatic alignment

2.10 Detection Module LSM BiG

Channels	2 channels with GaAsP detectors
Dynamic range	8-, 12- or 16-bit
Pinhole	Master pinhole of the LSM 710 with automatic alignment

2.11 Laser Insert RGB (pigtailed; 458, 488, 514, 543, 561, 594, 633 nm)

Single-mode polarization preserving fiber

Laser beam attenuation for all lasers by VIS-AOTF

Ar laser (458, 488, 514 nm, 25 or 35 mW)

HeNe laser (543 nm, 1 mW)

DPSS laser (561 nm, 20 mW)

HeNe laser (594 nm, 2 mW)

HeNe laser (633 nm, 5 mW)

2.12 Laser Insert V (pigtailed; 405, 440 nm)

Single-mode polarization preserving fiber

Laser beam attenuation by directly modulation

Diode laser (405 nm, 30 mW)

Diode laser pulsed/cw (405 nm, 30 mW):

- cw mode
 - max power ca. 15 mW on fiber out
 - range 0.6-15 mW w/o
 - attenuator, attenuation by a factor of 25
- pulsed mode
 - repetition rate 20-50-80 MHz
 - mean power: @20 MHz - ca. 0.2 mW; @50 MHz - ca. 0.5 mW; @80 MHz - ca. 0.8 mW
 - peak power: 50-300 mW
 - pulse width: 50-90 ps
 - jitter < 20 ps

Diode laser pulsed/cw (440 nm, 25 mW):

- cw mode
 - max power ca. 15 mW on fiber out
 - range 0.6-15 mW w/o
 - attenuator, attenuation by a factor of 25
- pulsed mode
 - repetition rate 20-50-80 MHz
 - mean power: @20 MHz - ca. 0.1 mW; @50 MHz - ca. 0.25 mW; @80 MHz - ca. 0.4 mW
 - peak power: 50-300 mW
 - pulse width: 50-90 ps
 - jitter < 20 ps

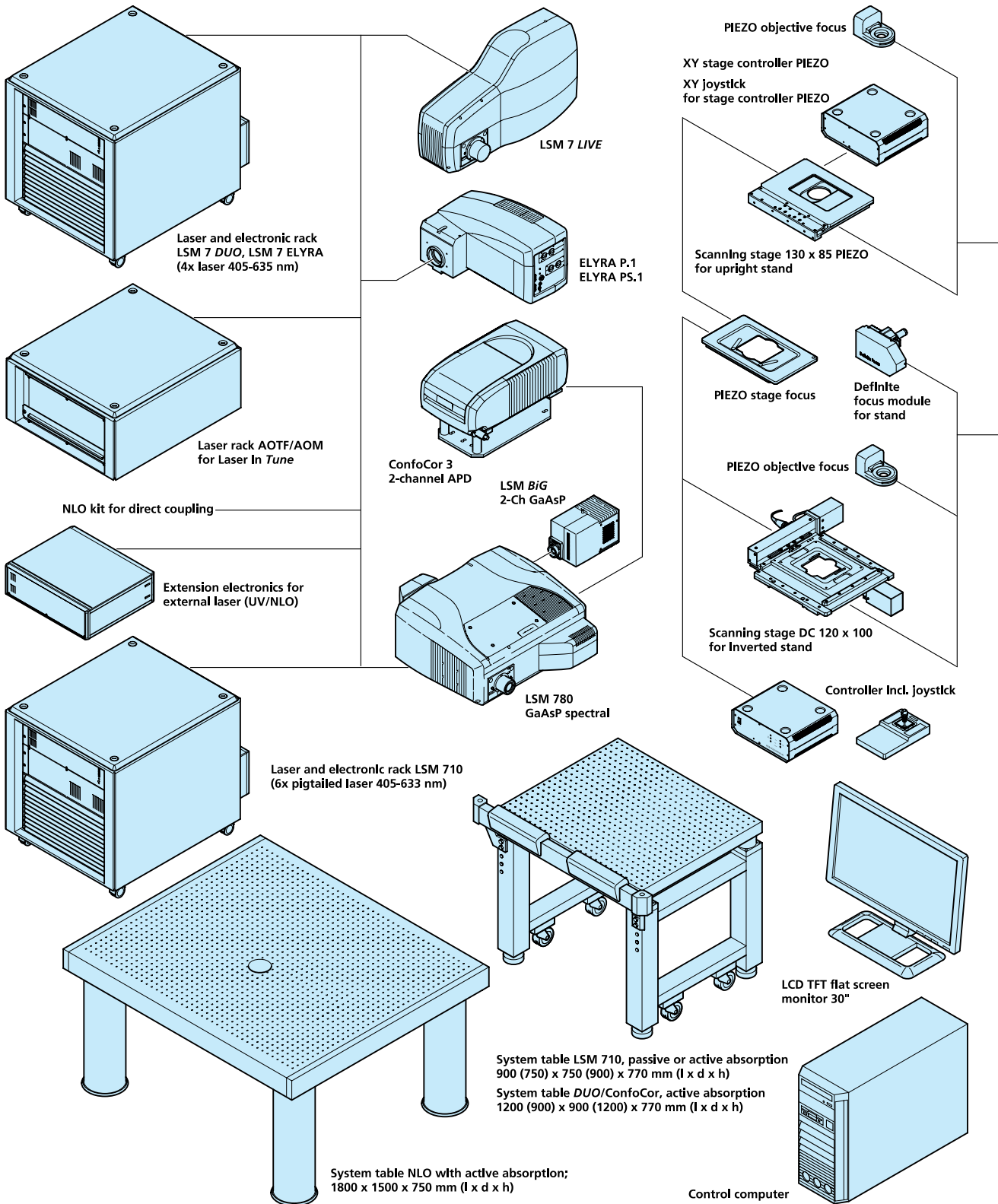
2.13 Tunable Laser In Tune 488-640 nm

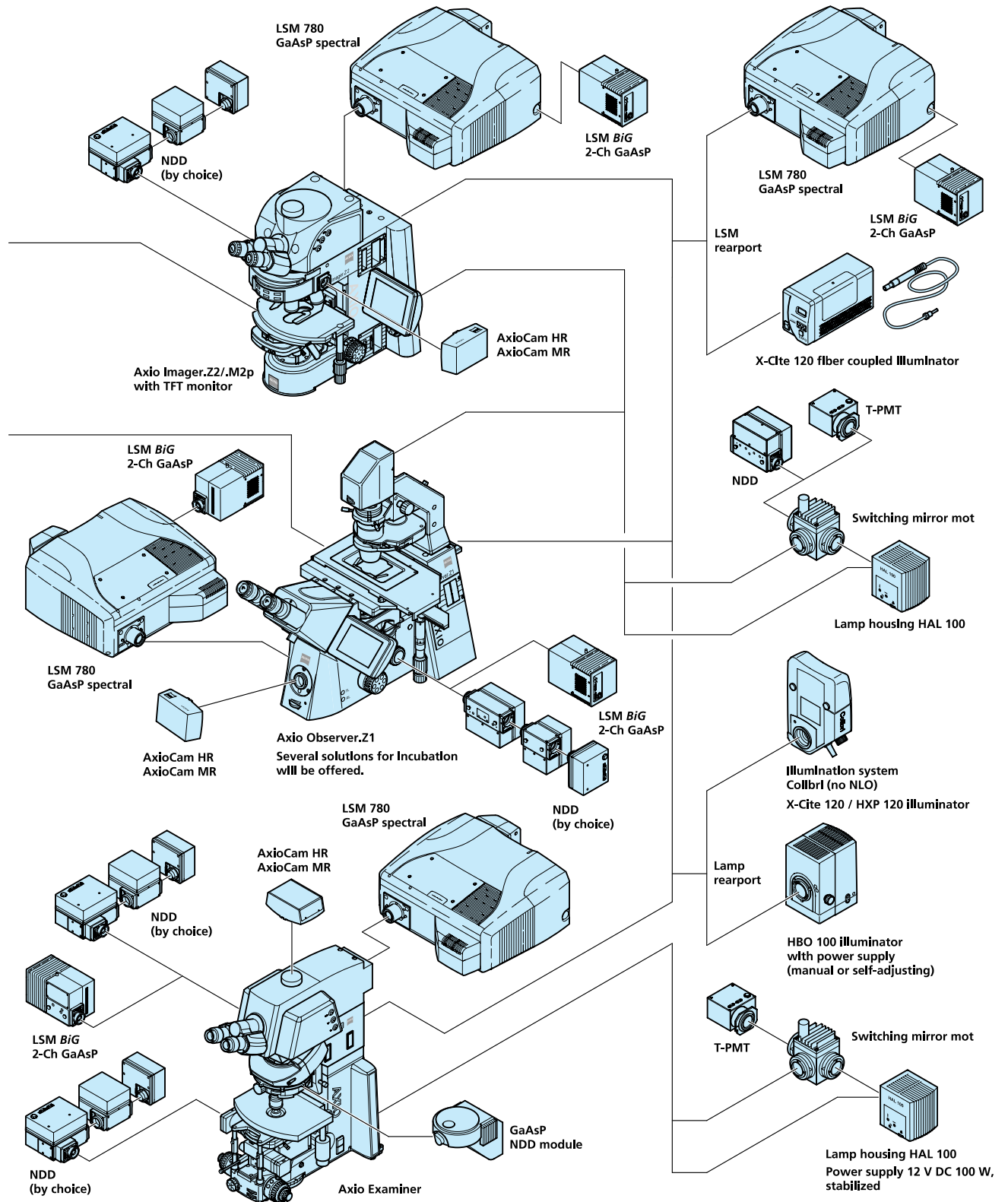
Single-mode polarization preserving fiber

Laser beam attenuation by AOTF

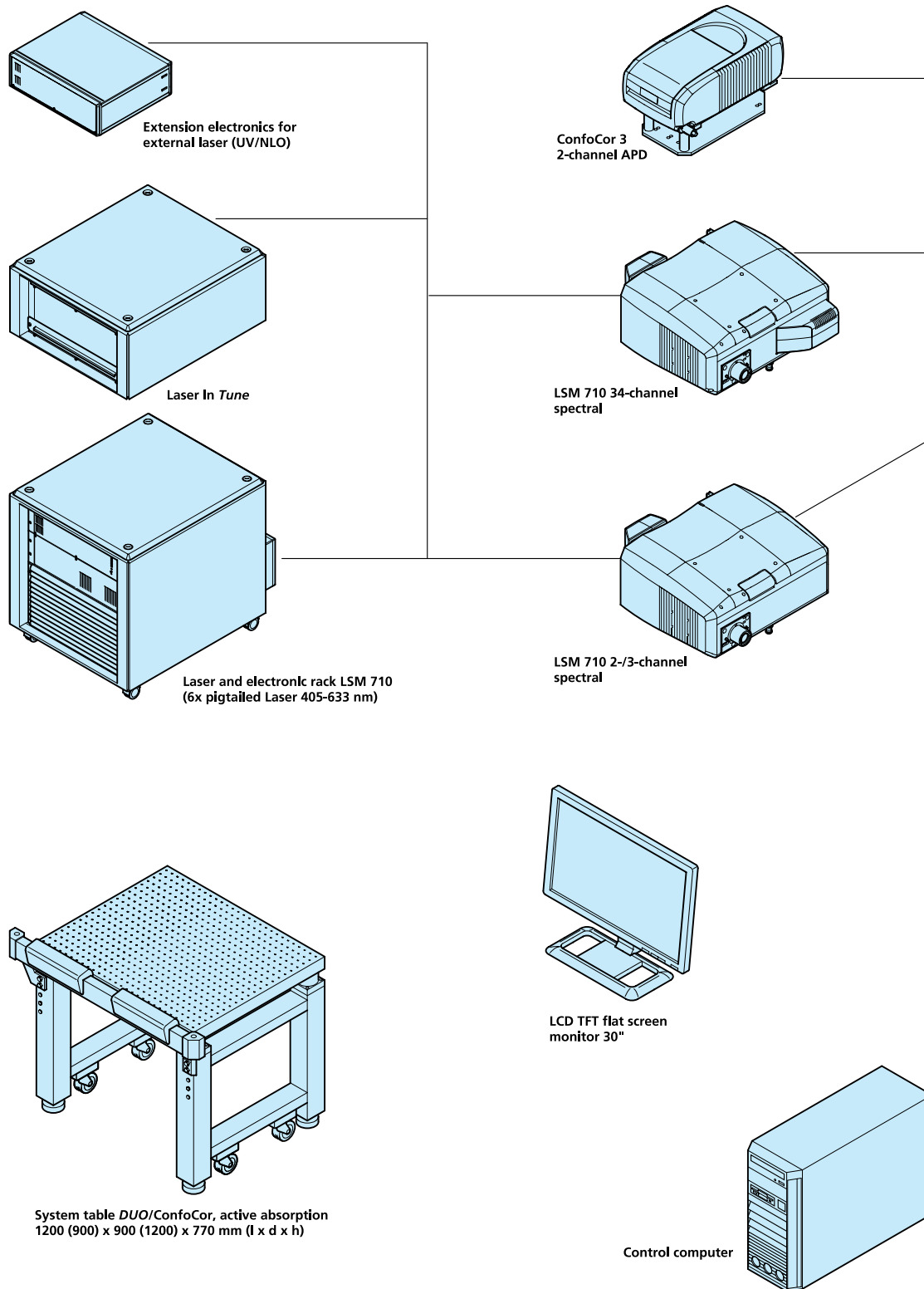
488 – 640 nm, 1,5 mW average power

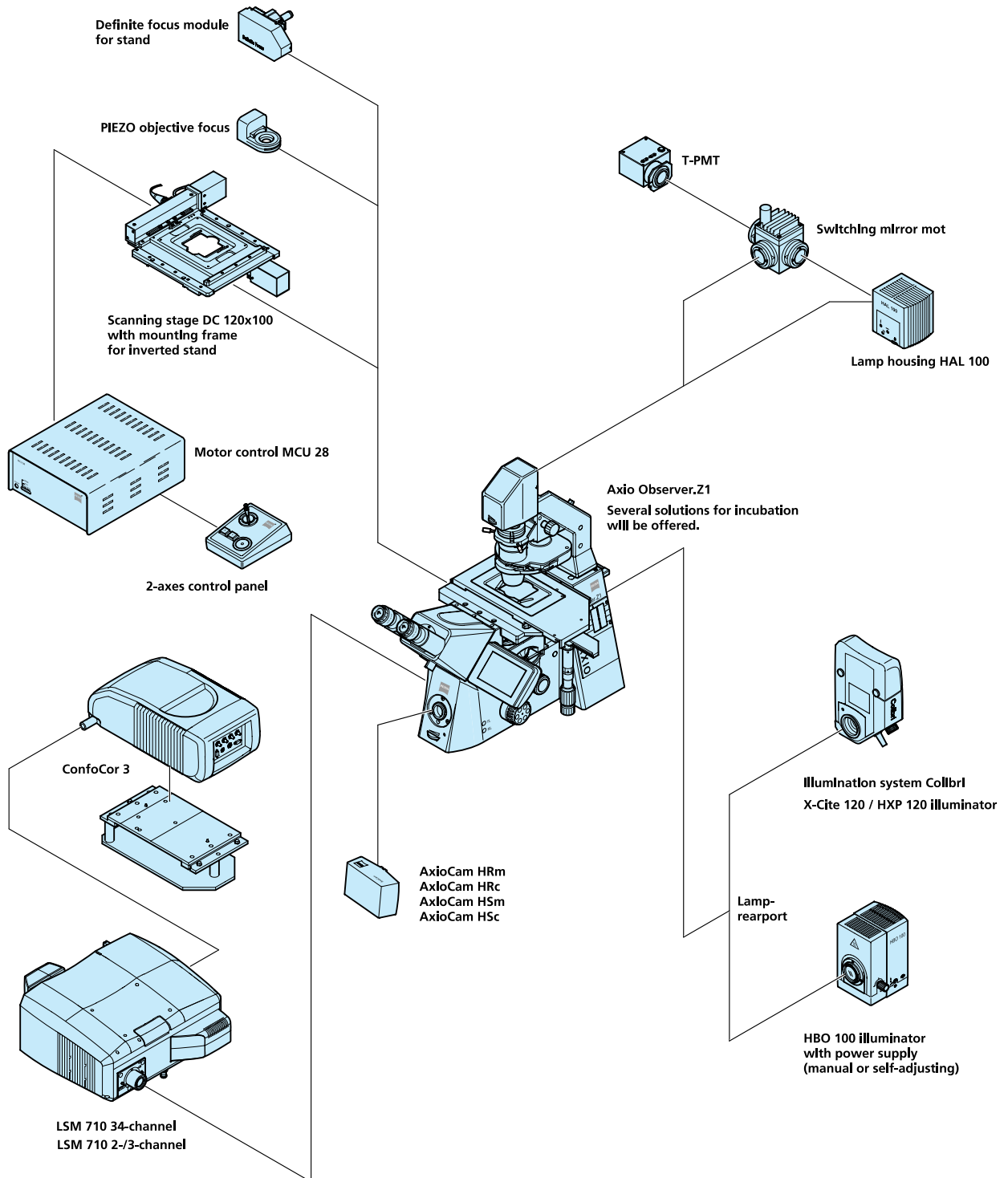
2.14 System Overview LSM 710 and LSM 780





2.15 System Overview LSM 710 and LSM 780 with ConfoCor 3





Quick Guide

LSM 710, LSM 780 Systems and ConfoCor 3 Laser Scanning Microscopes



LSM Software ZEN 2010
February 2010



We make it visible.

Contents

	Page
Contents	1
Introduction	1
Starting the System	2
Introduction to ZEN – Efficient Navigation	5
Setting up the microscope	10
Configuring the beam path and lasers	12
Scanning an image	17
Storing and exporting image data	22
Using the ConfoCor 3 module	23
Switching off the system	29

Introduction

This Quick Guide describes the basic operation of the LSM 710, LSM 780, LSM 710 NLO, LSM 780 NLO and ConfoCor 3 Laser Scanning microscopes with the ZEN 2010 software.

The purpose of this document is to guide the user to get started with the system as quick as possible in order to obtain some first images from his samples.

This Quick Guide does NOT replace the detailed information available in the full user manual or in the manual of the respective microscopes (Axio Imager, Axio Observer, Axio Examiner).

Also, this Quick Guide is written for a user who is familiar with the basics of Laser Scanning Microscopy.



For your safety!
Observe the following instructions:

- The LSM 710, LSM 780, LSM 710 NLO, LSM 780 NLO and ConfoCor 3 Laser Scanning Microscope, including its original accessories and compatible accessories from other manufacturers, may only be used for the purposes and microscopy techniques described in this manual (intended use).
- In the Operating Manual, read the chapter *Safety Instructions* carefully before starting operation.
- Follow the safety instructions described in the operating manual of the microscope and X-Cite 120 lamp / HBO 100 mercury lamp.

Starting the System

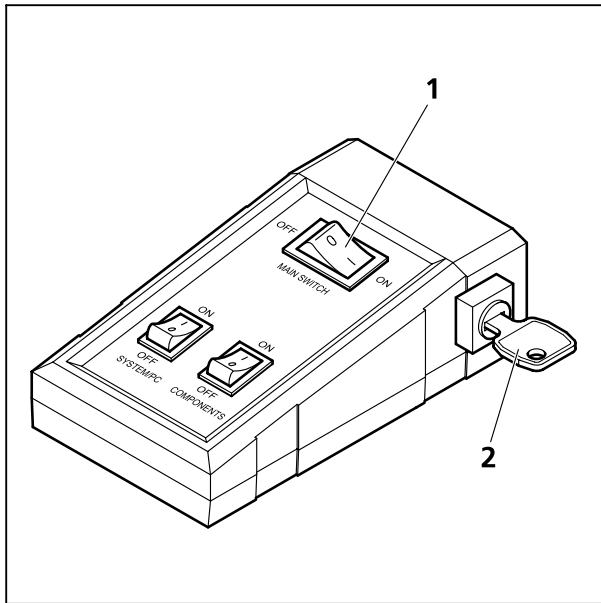


Fig. 1 Power remote switch

Switching on the LSM system

- Switch on the main switch (Fig. 1/1) and the safety lock (Fig. 1/2).
- When set to **ON** the power remote switch labeled **System/PC** provides power to the computer. This allows use of the computer and ZEN software offline
- To completely switch on the system, now press the **Components** switch to **ON**. This starts the other components and the complete system is ready to be initialized by the ZEN software.

Switching on the X-Cite 120 or the HBO 100 mercury lamp

- Switch on the main switch of the X-Cite 120 / HBO 100 lamp for reflected light illumination via the power supply as described in the respective operating manual.

Switching on the Ar-ML Laser

- If the Ar-ML laser is required, switch it on via the toggle switch (Fig. 2/2) on the power supply and turn the key (Fig. 2/1). The laser is automatically kept in standby mode for 5 minutes to warm up.
- Set the idle-run-switch (Fig. 2/3) to run. It takes about 50s until the laser has reached the set output power (green LED) provided the warm up time of 5 minutes is already completed.
- Adjust the required power level with the control knob (Fig. 2/4) (default position should be 11 o'clock).

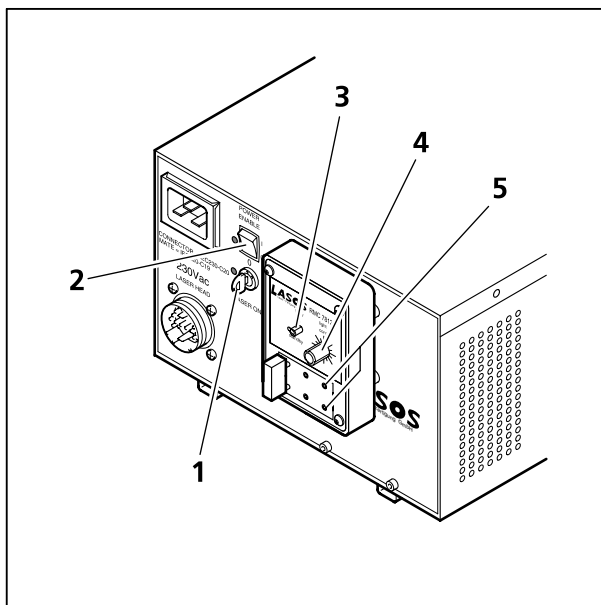


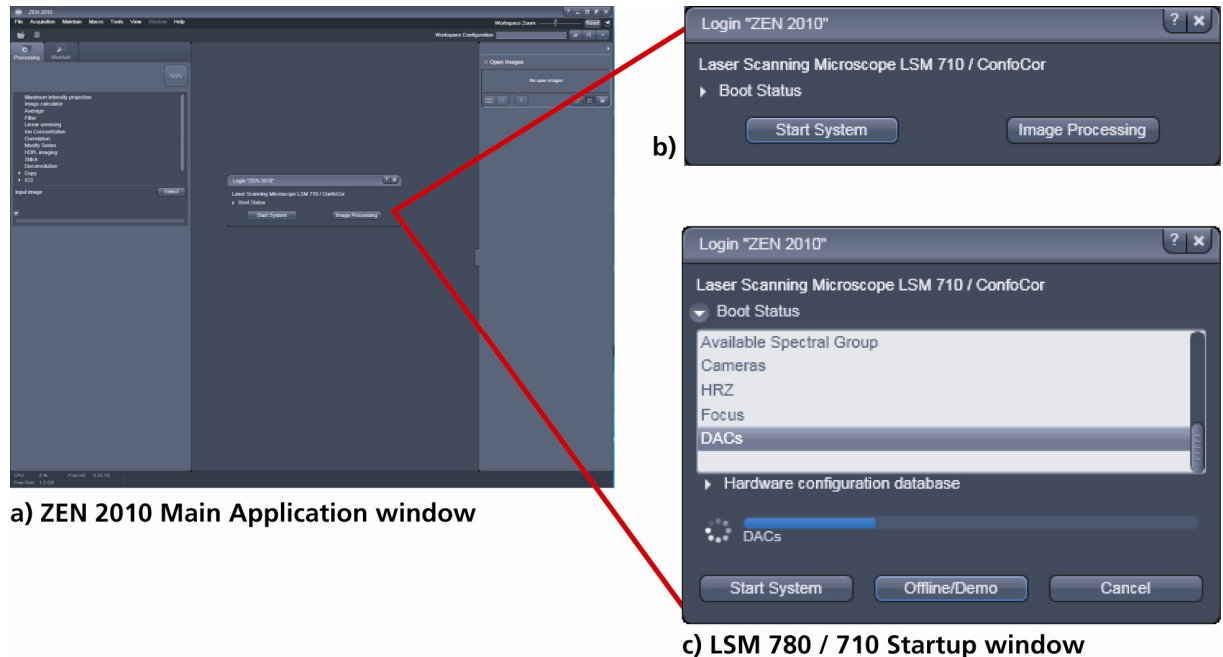
Fig. 2 Power supply of Ar-ML laser

Starting the ZEN software



- Double click the **ZEN 2010** icon on the WINDOWS desktop to start the Carl Zeiss LSM software.

The **ZEN Main Application** window and the **LSM 710 / LSM 780 Startup** window appear on the screen (Fig. 3)




a) ZEN 2010 Main Application window

b)

c) LSM 780 / 710 Startup window

Fig. 3 ZEN Main Application window at Startup (a) and the LSM 710 / LSM 780 Startup window (b and c)

In the small startup window, choose either to start the system (**Start System** hardware for acquiring new images) or in **Image Processing** mode to edit already existing images. Toggle the little  symbol to view the Boot Status display and get the additional **Offline / Demo** button option:

- Choosing **Start System** initializes the whole microscope system and activates the entire software package for new image acquisition and analysis.
- The **Image Processing** mode ignores all hardware and activates only data handling and image processing functionality for already acquired images.
- The **Offline / Demo** mode reads the current hardware database but does not activate the system hardware for use. Instead, it simulates the system hardware for training purposes.
- Upon clicking the **Start System** button, the **Image Processing** button changes to a **Cancel** button. Click **Cancel** to interrupt/stop the **Startup** of the system.

After Startup, the ZEN Main Application Window (Fig. 4 and Fig. 5) opens. To benefit from all of ZEN's features, run the window in its full screen mode.

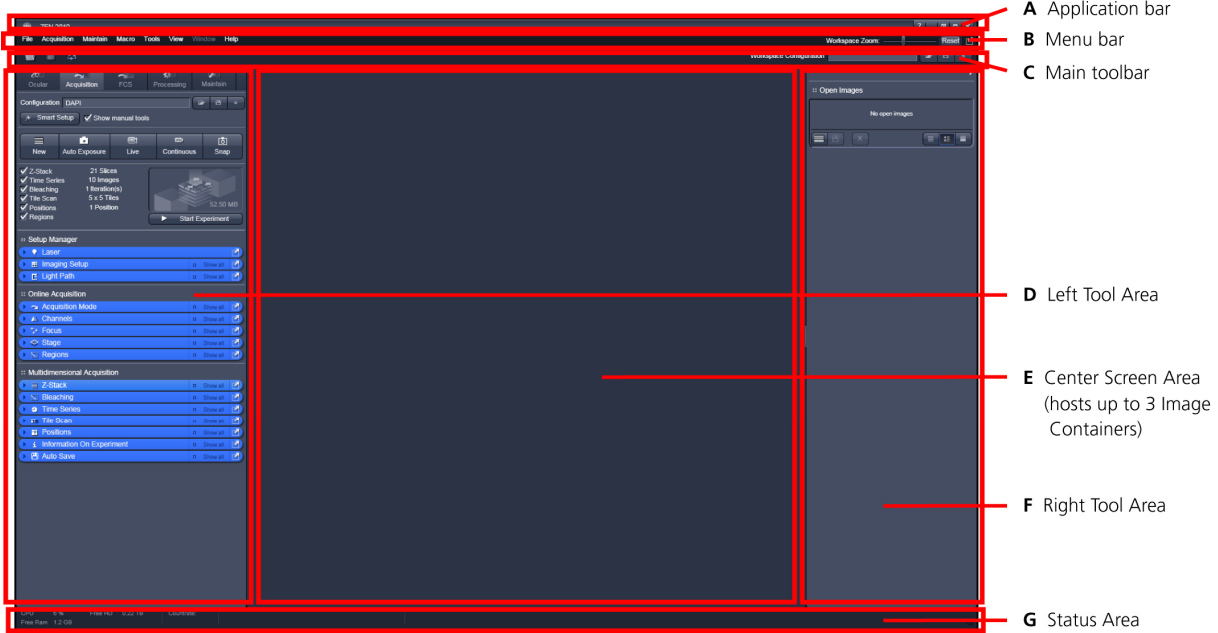
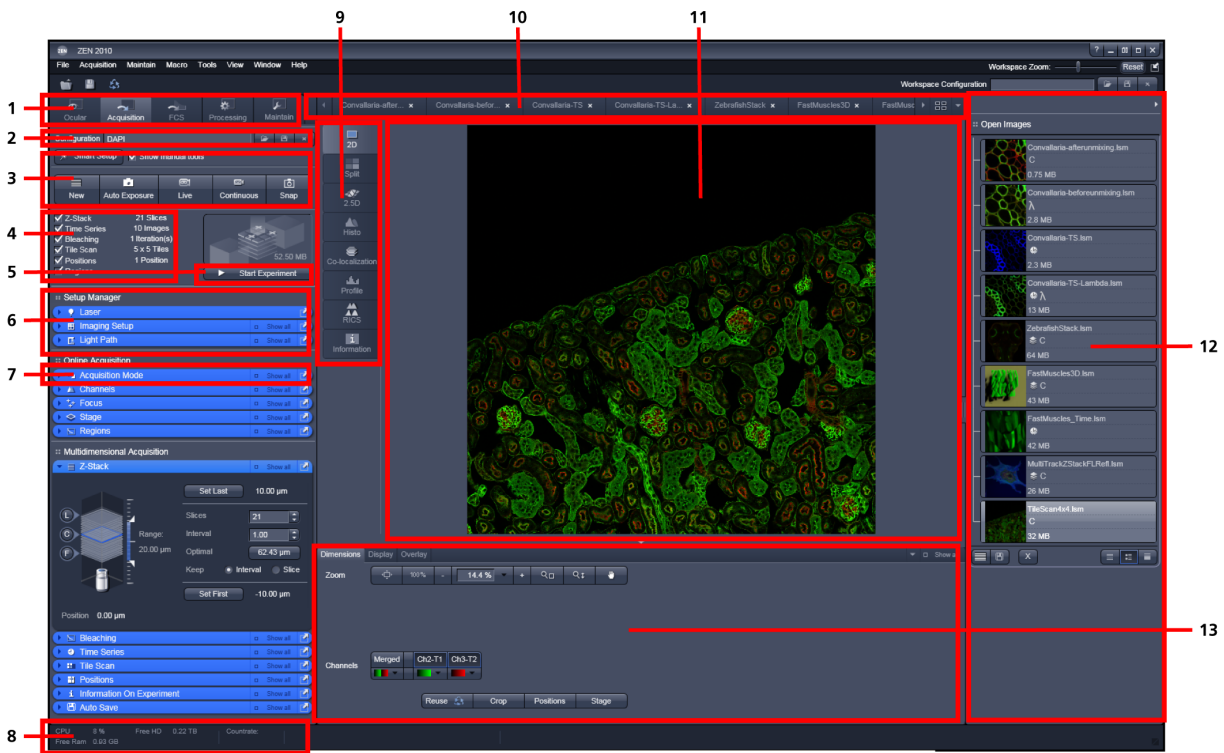


Fig. 4 ZEN Main Application Window after Startup with empty image container



- | | | | | |
|------------------|--|--------------|-----------------------|------------------|
| 1 Main tool tabs | 4 Multidimensional tools selection panel | 7 Tool | 10 Image tabs | 13 View controls |
| 2 Configurations | 5 Starting multidimensional experiments | 8 Status bar | 11 Displayed image | |
| 3 Action buttons | 6 Tool group | 9 View tabs | 12 File handling area | |

Fig. 5 ZEN Main Application Window after Startup with several images loaded

Introduction to ZEN – Efficient Navigation

The **ZEN 2010** interface is clearly structured and follows the typical workflow of the experiments performed with confocal microscopy systems:

On the **Left Tool Area** (Fig. 4/D) the user finds the tools for sample observation, image acquisition, image processing and system maintenance, easily accessible via four **Main Tabs** (Fig. 5/1). All functions needed to control the microscope can be found on the **Ocular Tab**, to acquire images use the **Acquisition Tools** (Fig. 5/3 and 4). Arranged from top to bottom they follow the logic of the experimental workflow. The area for viewing and interacting with images is centered in the middle of the **Main Application Window**: the **Center Screen Area**. Each displayed image can be displayed and/or analyzed with many view options available through view tabs which can be found on the left side of the image. According to the chosen view tab, the required view controls appear in View Control Tabs below each image. File management and data handling tools are found in the **Right Tool Area** (see Fig. 4 and Fig. 5).

Color and brightness of the interface have been carefully adjusted to the typical light conditions of the imaging laboratory, guaranteeing optimal display contrast and minimal stray light for high-sensitivity detection experiments. The **ZEN** software is optimized for a 30" TFT monitor but can also be used with dual-20" TFT setups.

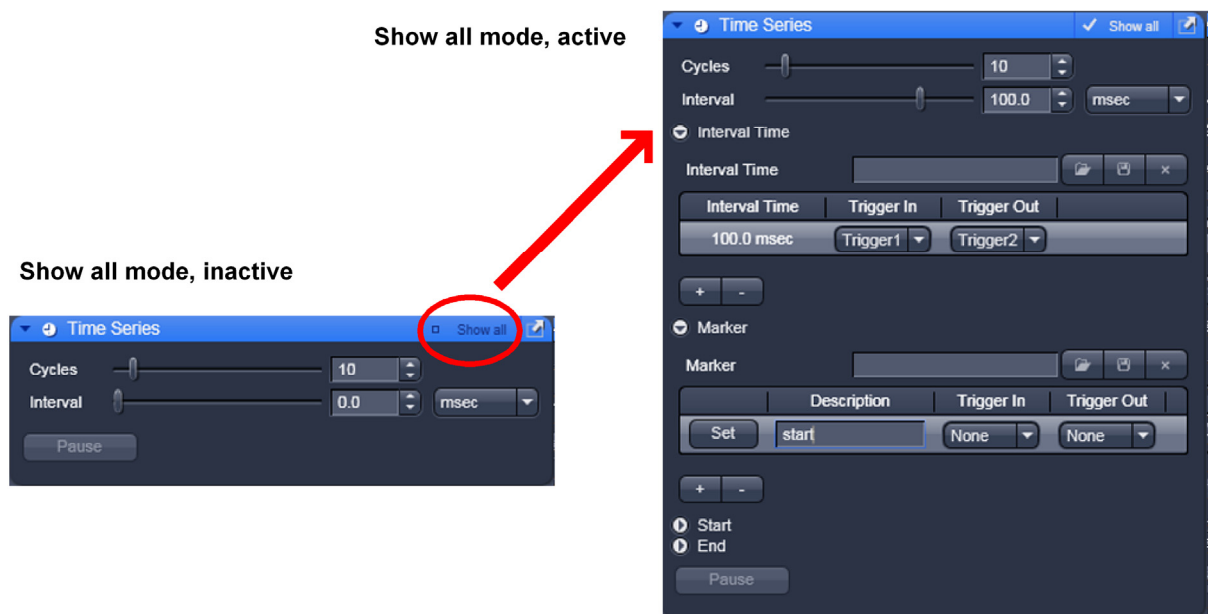
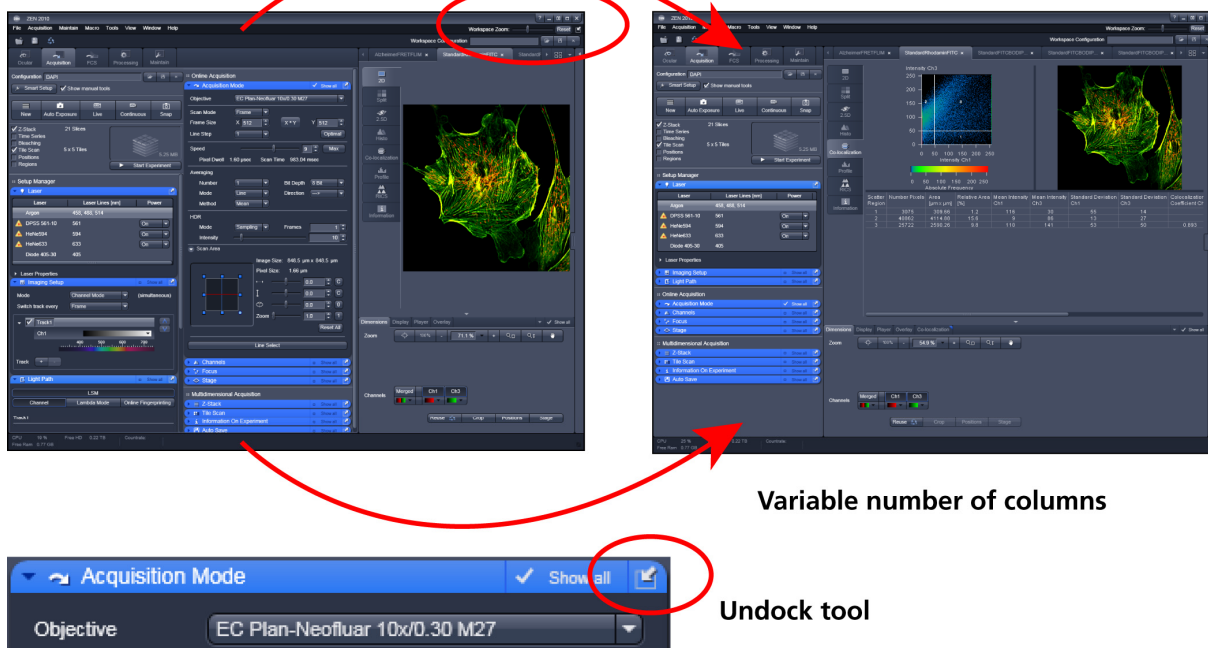


Fig. 6 Show all mode

A focus in the development of **ZEN 2010** was to fulfill the needs of both basic users and microscopy specialists. Both types of users will appreciate the set of intuitive tools designed to make the use of a confocal microscope from Carl Zeiss easy and fast:

The **Show all** concept ensures that tool panels are never more complex than needed. With **Show all** deactivated, the most commonly used tools are displayed. For each tool, the user can activate **Show all mode** to display and use additional functionality (Fig. 6).

Workspace zoom



Variable number of columns

Undock tool




Fig. 7 ZEN Window Layout configuration

More features of **ZEN 2010** include:

- The user can add more columns for tools to the **Left Tool Area** or detach individual tools to position them anywhere on the monitor. To add a column, drag a tool group by the title bar (e.g., Online Acquisition) to the right and a new tool column automatically opens. Alternatively use the context menu "move toolgroup to next column". To detach a tool, click on the little icon on the very right end of the blue tool header bar (Fig. 7).
- Another unique feature in Imaging Software is the scalable ZEN interface. This **Workspace Zoom** allows adjustment of the **ZEN 2010** window size and fonts to the situational needs or your personal preferences (Fig. 7).
- Setting up conventional confocal software for a specific experiment can take a long time and is often tedious to repeat. With **ZEN** these adjustments have to be done only once – and may be restored with just two clicks of the mouse. For each type of experiment one can now set-up and save the suitable **Workspace Layout**. These configurations can also be shared between users.
- For most controls, buttons and sliders, a **tool tip** is available. When the mouse pointer is kept over the button, a small pop-up window will display which function is covered by this tool/button.


These are just some of the most important features of the ZEN interface. For a more detailed description of the functionality for the **ZEN 2010** software, please refer to the User Manual that is provided with your system.

Setting up a new image document and saving your data

To create a new image document in an empty image container, click the **Snap**  or the **Auto Exposure**  button. For an empty image document press the **New**  button.

The new document is immediately presented in the **Open Images Area**. Remember, an unsaved 2D image in the active image tab will be over-written by a new scan. Multi-dimensional scans or saved images will never be over-written and a new scan will then automatically create a new image document.

Acquired data is **not** automatically saved to disc. Make sure you save your data appropriately and back it up regularly. The ZEN software will ask you if you want to save your unsaved images when you try to close the application with unsaved images still open.

 There is no image database any more like in the earlier Zeiss LSM software versions.

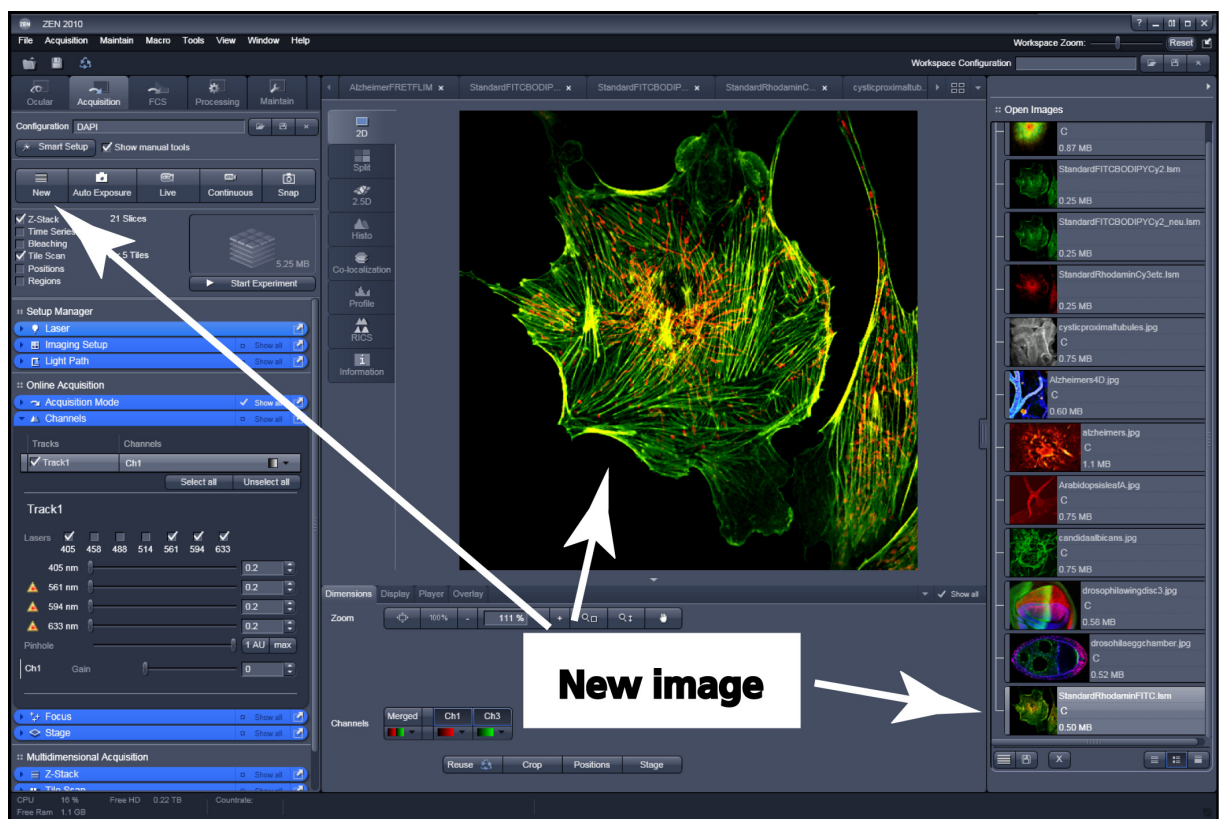


Fig. 8 New image document in the Open Images Areas

Advanced data browsing is available through the **ZEN File Browser** (Ctrl + F or from the **File Menu**). The ZEN File Browser can be used like the WINDOWS program file browser. Images can be opened by double-click and image acquisition parameters are displayed with the thumbnails (Fig. 9). For more information on data browsing please refer to the detailed operating manual.

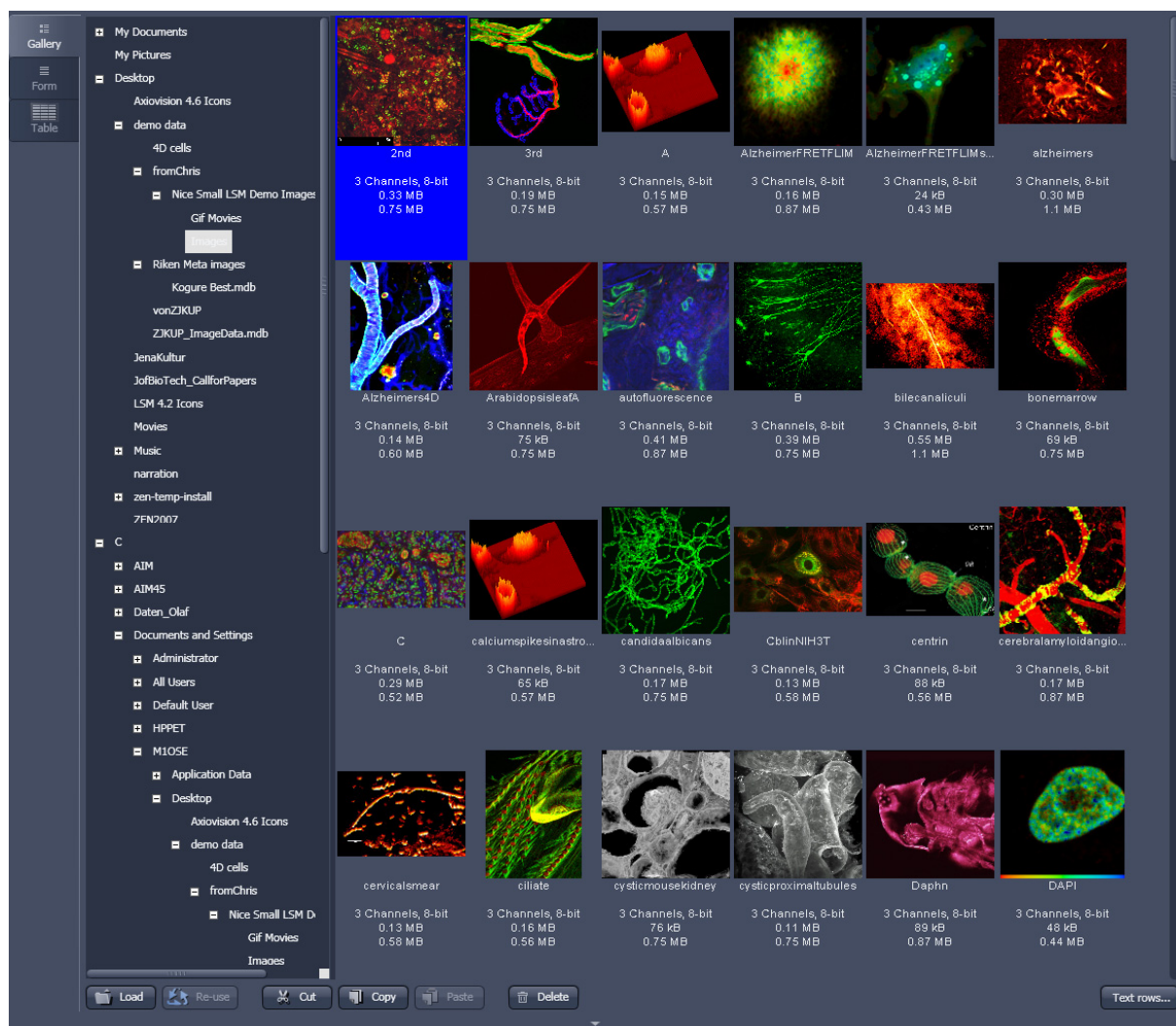


Fig. 9 File Browser

Turning on the lasers

ZEN 2010 operates all lasers automatically. Whenever they are used (manually or by the **Smart Setup** function) the lasers are turned on automatically. The **Laser Life Extender** function of the software shuts all lasers off if ZEN is not used for more than 15 minutes.

To manually switch lasers on or off:

- Click the **Show manual tools** tickbox and open the **Laser** tool. All available lasers can be operated within this tool (Fig. 10).

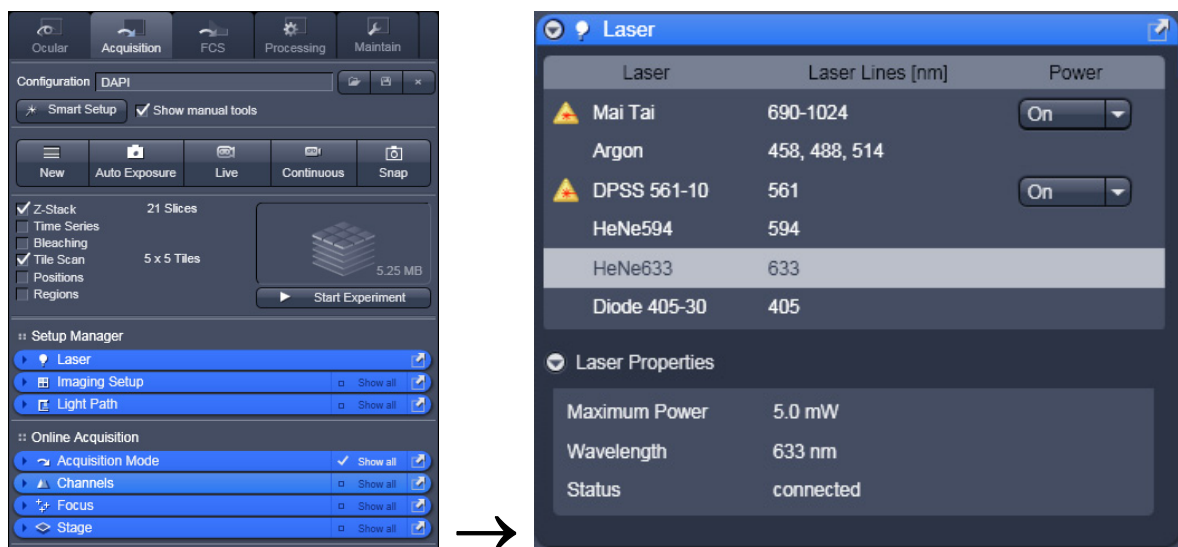
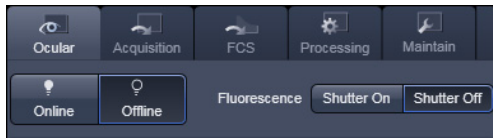


Fig. 10 Laser Control tool

Setting up the microscope

Changing between direct observation and laser scanning mode

The **Ocular** and **Acquisition** buttons switch between the use of the LSM and the microscope:



- Click on the **Ocular** button to open the controls for the microscope beam path and for direct observation via the eyepieces of the binocular tube, lasers are blocked.
- To set the hardware in position for using the microscope, click **Online** if not yet active.
- To close the light shutters on the microscope click **Offline**.
- Click on the **Acquisition** button to move back to the LSM system.

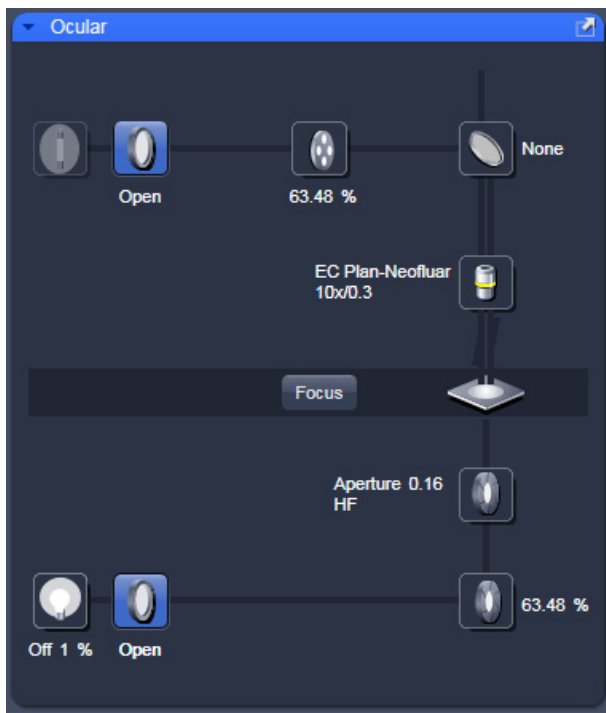
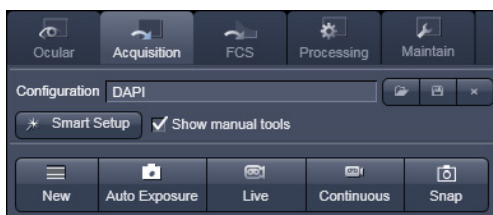


Fig. 11 Microscope Control window, e.g.: Axio Imager.Z2

Setting up the microscope and storing settings

Click on the **Ocular** tab for direct observation; press the **Online** button for your actions to take effect immediately. Then open the **Ocular** tool to configure the components of your microscope like filters, shutters or objectives (Fig. 11).

Selecting an objective

- Open the graphical pop-up menu by clicking on the **Objective** symbol and select the objective lens for your experiment (Fig. 11).
- The chosen objective lens will automatically move into the beam path.

Focusing the microscope for transmitted light




- Open the graphical pop-up menu by clicking on the **Transmitted Light** icon (Fig. 12).
- Click on the **On** button. Set the intensity of the Halogen lamp using the slider.
- Clicking outside the pop-up control closes it.
- Place specimen on microscope stage. The cover slip must be facing the objective lens. Remember the immersion medium if the objective chosen requires it!

- Use the focusing drive of the microscope to focus the object plane.
- Select specimen detail by moving the stage in X and Y using the XY stage fine motion control.


Setting the microscope for reflected light

- Click on the **Reflected Light** icon to open the X-Cite 120 Controls and turn it on.
- Click on the **Reflected Light** shutter to open the shutter of the X-Cite 120 lamp / HBO100.
- Click on the **Reflector** button and select the desired filter set by clicking on it.

Storing the microscope settings

Microscope settings can be stored as configurations (Fig. 13) by typing a config name in the pull-down selector and pressing the save  button. Fast restoration of a saved config is achieved by selecting the config from the pull-down list and pressing the  load button. The current config can be deleted by pressing the delete  button.

These configurations can be assigned to buttons that are easier to press.

-  Depending on the microscope configuration, settings must be done manually if necessary.

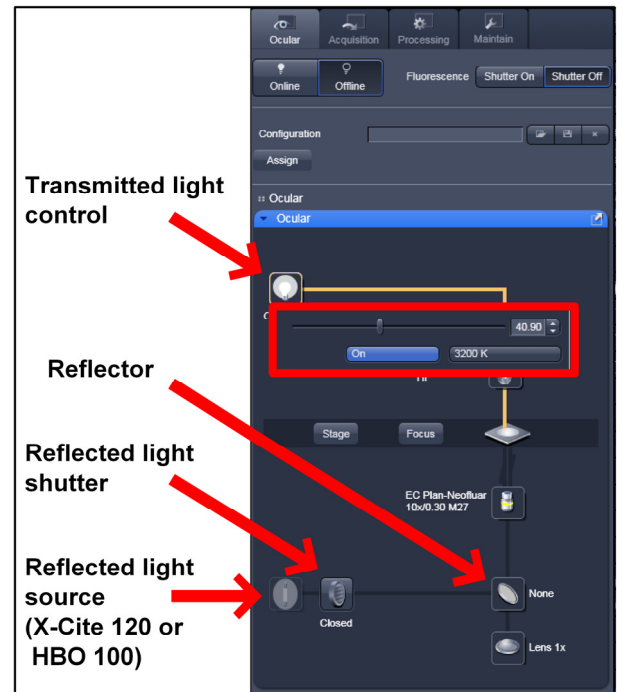


Fig. 12 Microscope Control window with Transmitted Light pop-up menu

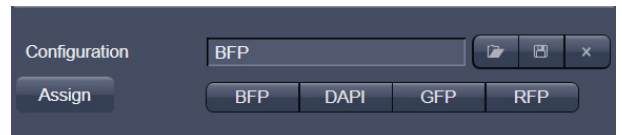
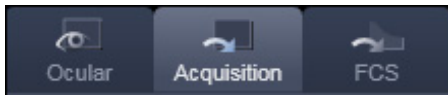


Fig. 13 Configuration panel

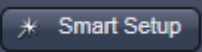
Configuring the beam path and lasers



- Click the **Acquisition** button.

Smart Setup

The tool **Smart Setup** is an intuitive, user-friendly interface which can be used for almost all standard applications. It configures all the system hardware for a chosen set of dyes.

- Click on the **Smart Setup** button  to open the smart setup window. This window can be accessed any time from the software to change dye combinations.
- Click on the arrow in the dye list and simply choose the dye(s) you want to use in your experiment from the list dialogue. In this dialogue, the dyes can be also searched by typing the name in the search field.

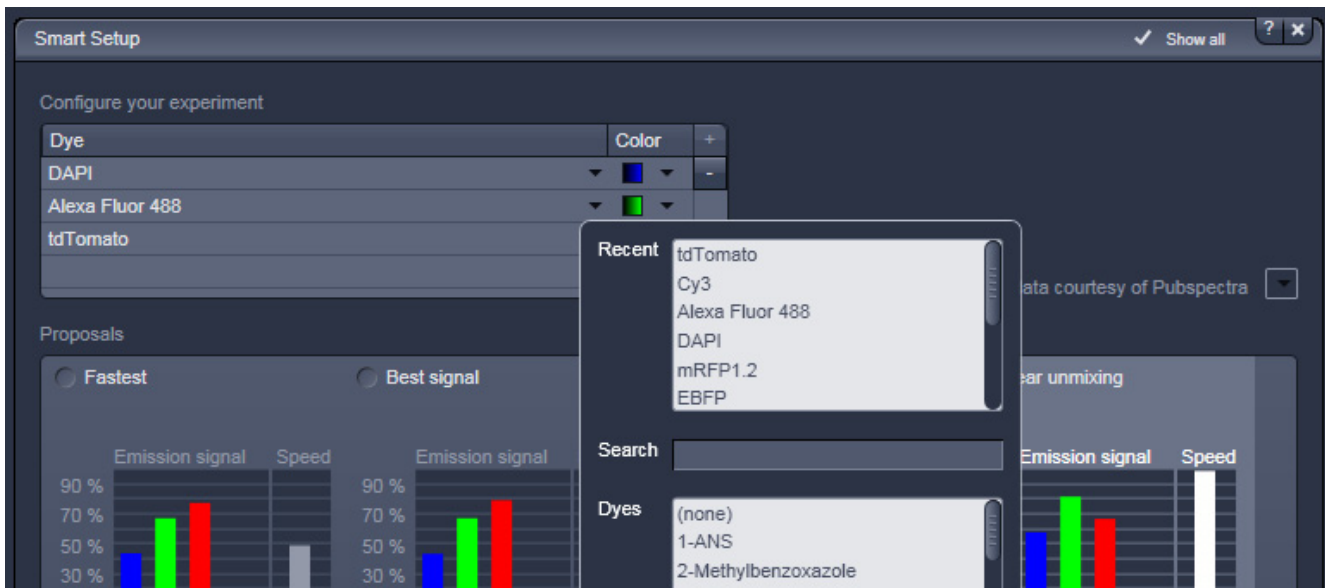


Fig. 14 Smart setup tool

Once finished with the input, **Smart Setup** suggests four alternative considerations (see below): One for **fastest** imaging, one for the **best signal**, **best compromise** between both speed and best signal and the optimal setup for later **linear unmixing** of the dyes.

The graphs display relative values for the expected emission signals and cross-talk. The resulting imaging scheme (single or multitrack) is shown below the graphs.

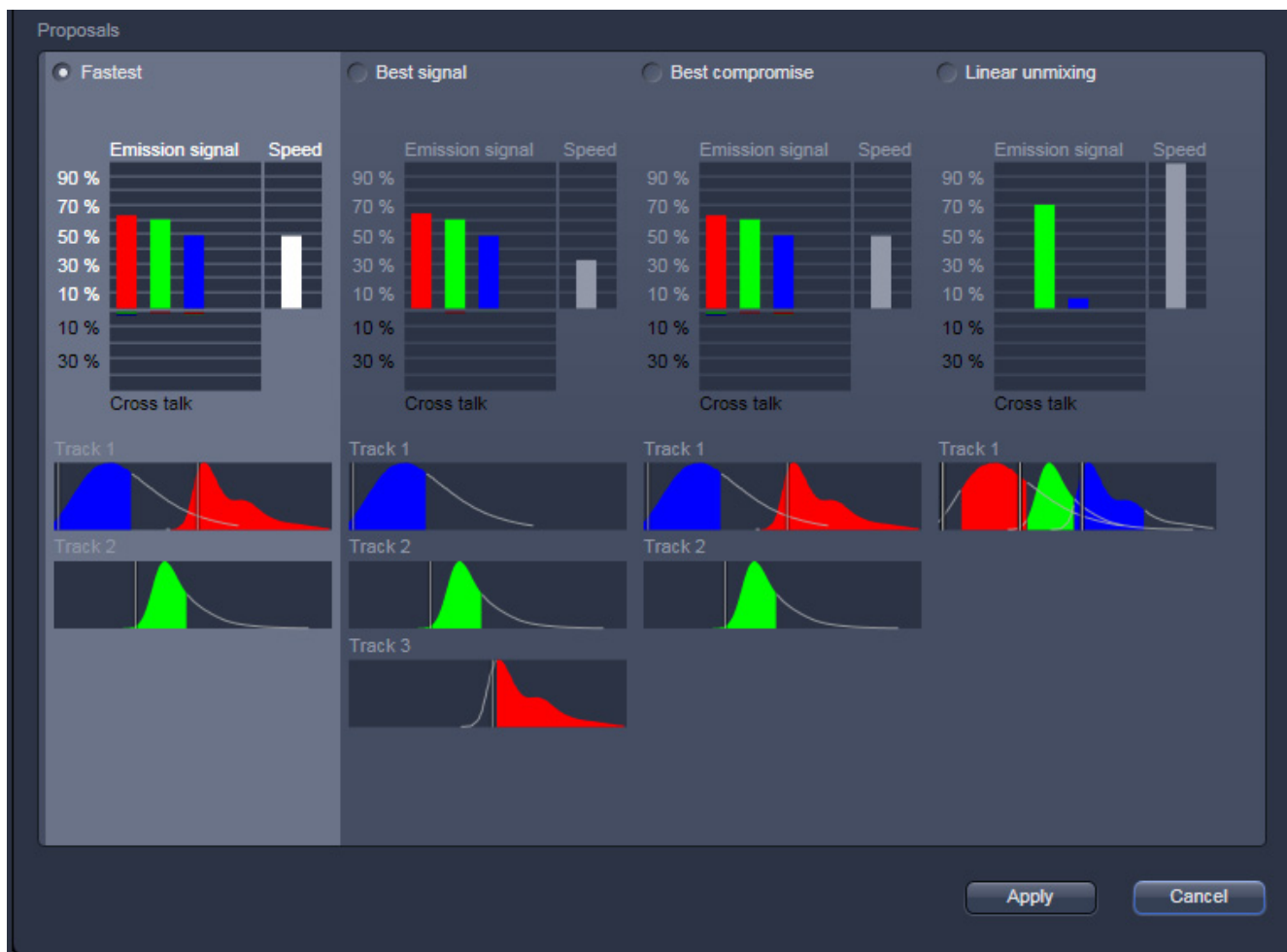
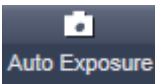


Fig. 15 Proposals panel of the Smart Setup tool

Pressing **Apply**, automatically sets the hardware parameters in the displayed way for the dyes chosen.

If the option **Linear Unmixing** is selected, the system is set in the lambda mode automatically.

Pressing the **Auto Exposure**  button will then optimize the settings of the Gain (Master) and offset for the given laser power and pinhole size. Further image optimisation from this point can be done easily.

Setting up a configuration manually

Simultaneous scanning of single, double and triple labeling:

- Advantage: faster image acquisition
- Disadvantage: potential cross-talk between channels

Sequential scanning of double and triple labeling; line-by-line or frame-by-frame:

- Advantage: Only one detector and one laser are switched on at any one time. This reduces cross-talk.
- Disadvantage: slower image acquisition

- Open the **Imaging Setup** and the **Light Path** tool in the **Setup Manager** Tool group to access the hardware control window to set-up the beam path.

The open **Light Path** is shown in Fig. 16.

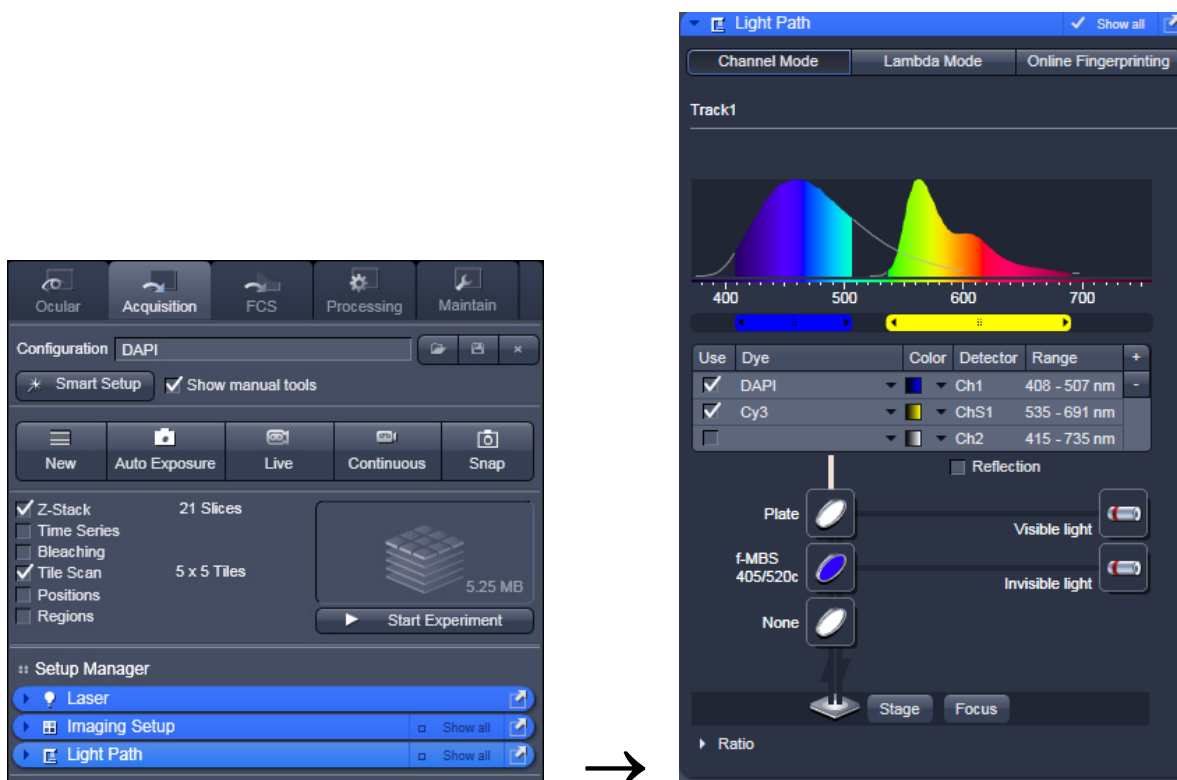


Fig. 16 Light Path tool for a single track (LSM)

Settings for track configuration in Channel Mode

- Select **Channel Mode** if necessary (Fig. 17).

The **Light Path** tool displays the selected track configuration which is used for the scan procedure.

- You can change the settings of this panel using the following function elements:

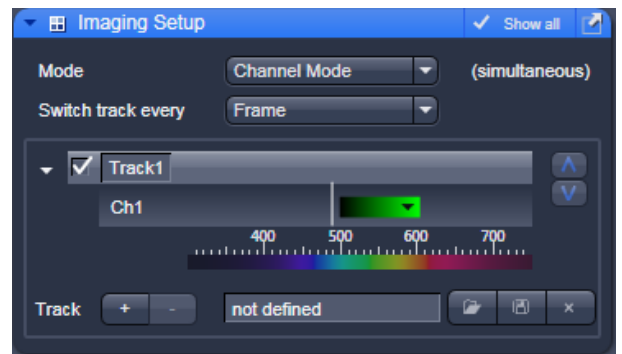


Fig. 17 Imaging Setup tool for a single track (LSM)



Activation / deactivation of the excitation wavelengths (check box) and setting of excitation intensities (slider). If necessary open the **Laser Control** tool (see above).



Selection of the main dichroic beam splitter (MBS) from the relevant list box.



Selection of an emission filter through selection from the relevant list box.



Activation / deactivation (via check box) of the selected channel (Ch 1-4, monitor diode ChM, QUASAR detectors ChS1-8, transmission ChD) for the scanning procedure and assigning a color to the channel.

- Select the appropriate filters and activate the channels.
- Click the **Laser** icon to select the laser lines and set the attenuation values (transmission in %) in the displayed window.
- For the configuration of the beam path, please refer to the application-specific configurations depending on the used dyes and markers and the existing instrument configuration.
- In the **Imaging Setup** tool the Detection Bands & Laser Lines are displayed in a spectral panel (Fig. 18) to visualize the activated laser lines for excitation (vertical lines) and activated detection channels (colored horizontal bars).

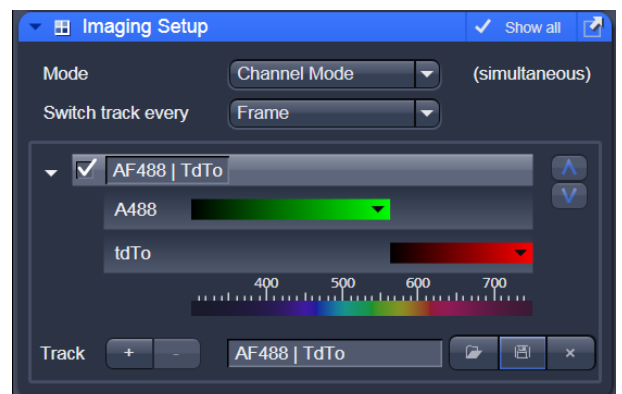


Fig. 18 Detection Bands & Laser Lines display

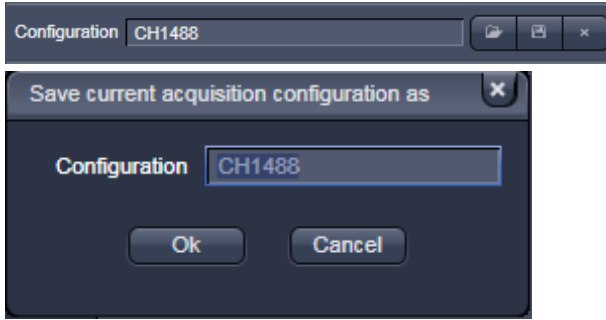





Fig. 19 Track Configurations window

- For storing a new configuration click  and enter a desired name in the first line of the list box (Fig. 19), then click **Ok** to store the configuration.
- For loading an existing configuration click  then select it from the list box.
- For deleting an existing configuration click  then select it from the list box and confirm the deletion with **Ok**.

Settings for multiple track configurations in Channel Mode

Multiple track set-ups for sequential scanning can be defined as one configuration (**Channel Mode Configuration**), to be stored under any name, reloaded or deleted.

The maximum of four tracks with up to eight channels can be defined simultaneously and then scanned one after the other. Each track is a separate unit and can be configured independently from the other tracks with regard to channels, Acousto-Optical Tunable Filters (AOTF), emission filters and dichroic beam splitters.

The following functions are available in the **List of Tracks** panel in the **Imaging Setup Tool** (Fig. 17, Fig. 18 and Fig. 19).

Switch track every

- Line** Tracks are switched during scanning line-by-line. The following settings can be changed between tracks: Laser line, laser intensity and channels.
- Frame** Tracks are switched during scanning frame-by-frame. The following settings can be changed between tracks: Laser line and intensity, all filters and beam splitters, the channels incl. settings for gain and offset and the pinhole position and diameter.
- Frame Fast** The scanning procedure can be made faster. Only the laser line intensity and the **Amplifier Offset** are switched, but no other hardware components. The tracks are all matched to the current track with regard to emission filter, dichroic beam splitter, setting of Detector Gain, pinhole position and diameter. When the **Line** button is selected, the same rules apply as for **Frame Fast**.



Add Track button

An additional track is added to the configuration list in the **Imaging Setup Tool**. The maximum of four tracks can be used. One track each with basic configuration is added, i.e.: Ch 1 channel is activated, all laser lines are switched off, emission filters and dichroic beam splitters are set in accordance with the last configuration used.

 **Remove** button

The track marked in the **List of Tracks** panel is deleted.



A click on this arrow button will move the selected track (highlighted in light grey) one position upwards in the list box.



A click on this arrow button will move the selected track (highlighted in light grey) one position downwards in the list box.

Scanning an image

Setting the parameters for scanning

- Select the **Acquisition Mode** tool from the **Left Tool Area** (Fig. 20).
- Select the **Frame Size** as predefined number of pixels or enter your own values (e.g. 300 x 600) in the **Acquisition Mode** tool. Click on the **Optimal** button for calculation of appropriate number of pixels depending on objective N.A. and λ .

The number of pixels influences the image resolution!

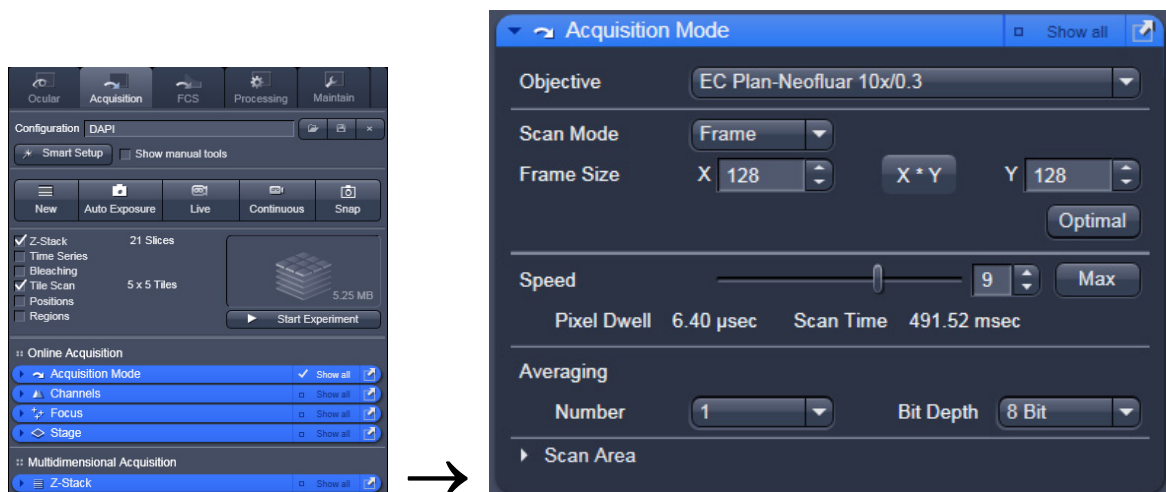


Fig. 20 Acquisition Mode tool

Adjusting scan speed

- Use the **Scan Speed** slider in the **Acquisition Mode** tool (Fig. 20) to adjust the scan speed.

A higher speed with averaging results in the best signal-to-noise ratio. Scan speed 8 usually produces good results. Use speed 6 or 7 for superior images.

Choosing the dynamic range

- Select the dynamic range 8 or 12 Bit (per pixel) in the **Bit Depth** pull-down in the **Acquisition Mode** tool (Fig. 20).

8 Bit will give 256 gray levels; 12 Bit will give 4096 gray levels. Publication quality images should be acquired using 12 Bit data depth. 12 Bit is also recommended when doing quantitative measurements or when imaging low fluorescence intensities.

Setting scan averaging

Averaging improves the image by increasing the signal-to-noise ratio. Averaging scans can be carried out line-by-line or frame-by-frame. Frame averaging helps to reduce photo-bleaching, but does not give quite as smooth of an image.

- For averaging, select the **Line** or **Frame** mode in the **Acquisition Mode** tool.
- Select the number of lines or frames to average.

Adjusting pinhole size

- Select the **Channels** tool in the **Left Tool Area**.
- Set the **Pinhole** size to **1 AU** (Airy unit) for best compromise between depth discrimination and detection efficiency.

Pinhole adjustment changes the **Optical Slice thickness**. When collecting multi-channel images, adjust the pinholes so that each channel has the same **Optical Slice thickness**. This is important for colocalization studies.

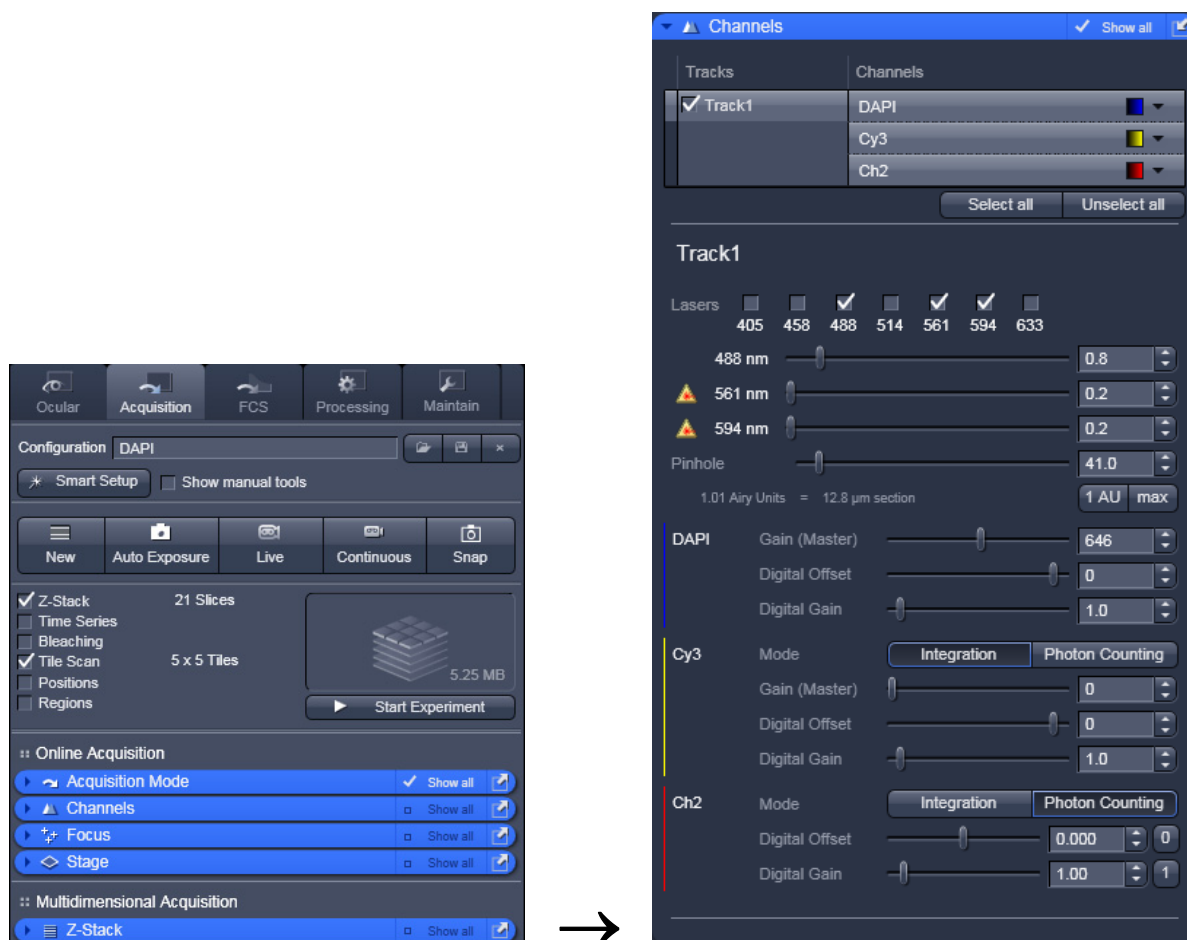
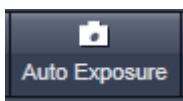


Fig. 21 Channels tool

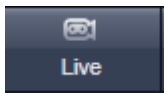
Image acquisition

Once you have set up your parameter as defined in the above section, you can acquire a frame image of your specimen.

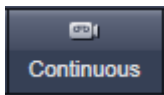
- Use one of the **Auto Exposure**, **Live**, **Continuous** or **Snap** buttons to start the scanning procedure to acquire an image.
- Scanned images are shown in separate windows.
- Click on the **Stop** button to stop the current scan procedure if necessary.



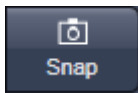
Select **Auto Exposure** for automatic pre-adjustment of detector gain and offset.



Select **Live** for continuous fast scanning – useful for finding and changing the focus.



Select **Continuous** for continuous scanning with the selected scan speed.



Select **Snap** for recording a single image.



Select **Stop** for stopping the current scan procedure.

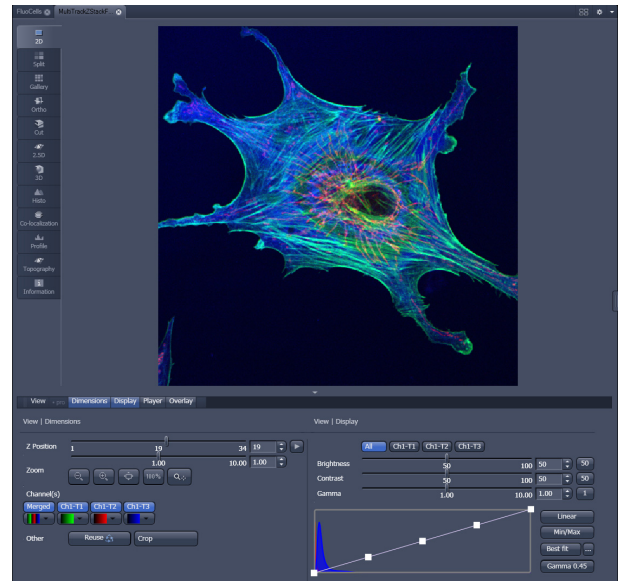




Fig. 22 Image Display

Image optimization

Choosing Range Indicator

- In the **View – Dimensions** View Option Control Block, click inside the color field in the  button under the channel button (Fig. 23).

- Clicking on the right hand side of the  button leads to a list of colors.

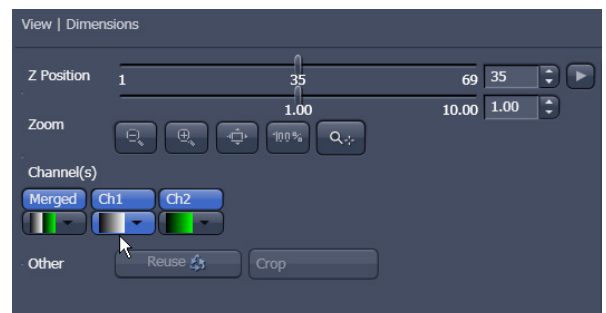


Fig. 23 View Dimensions Control Block

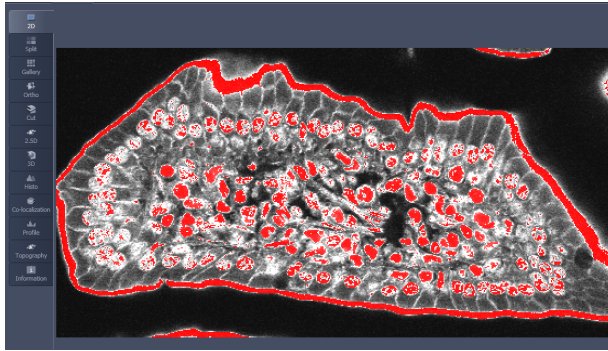


Fig. 24 Image Display

The scanned image appears in a false-color presentation (Fig. 24).

If the image is too bright, it appears red on the screen. Red = saturation (maximum).

If the image is not bright enough, it appears blue on the screen. Blue = zero (minimum).

Adjusting the laser intensity

- Set the **Pinhole** to **1** Airy Unit (Fig. 25).
- Set the **Gain (Master)** high.
- When the image is saturated, reduce AOTF transmission in the **Laser** control section of the **Channels Tool** (Fig. 25) using the slider to reduce the intensity of the laser light to the specimen.

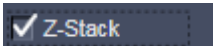
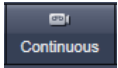
Adjusting gain and offset

- Increase the **Digital Offset** until all blue pixels disappear, and then make it slightly positive (Fig. 25).
- Reduce the **Gain (Master)** until the red pixels only just disappear.


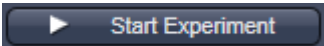

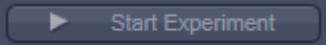


Fig. 25 Channels tool

Scanning a Z stack

- Select **Z-Stack**  in the main tools area.
- Open the **Z Stack** tool in the **Left Tool Area**.
- Select **Mode First/Last** on the top of the **Z-Stack** tool.
- Click on the  button in the **Action Button** area.

A continuous XY-scan of the set focus position will be performed.

- Use the focus drive of the microscope to focus on the upper position of the specimen area where the Z Stack is to start.
 - Click on the **Set First** button to set the upper position of the Z Stack.
 - Then focus on the lower specimen area where the recording of the Z Stack is to end.
 - Click on the **Set Last** button to set this lower position.
 - Click on the  button to set number of slices to match the optimal Z-interval for the given stack size, objective lens, and the pinhole diameter.
 - Click on the  **Start Experiment** button to start the recording of the Z-Stack.
-  When a multi-dimensional acquisition tool is not selected, the respective tool and its set parameters are not included in the multidimensional image acquisition. If no multidimensional tool is activated, the  **Start Experiment** button is grayed out and only single images can be scanned.

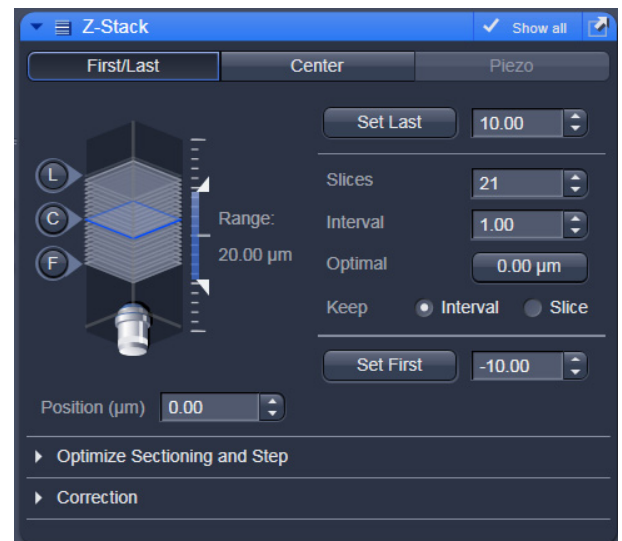


Fig. 26 Z Stack tool

Storing and exporting image data

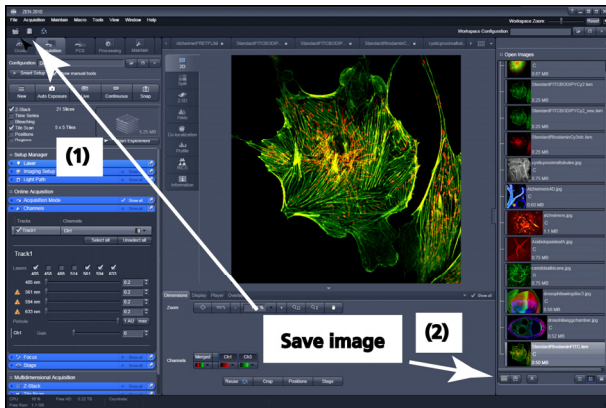


Fig. 27 Save Image buttons in ZEN

- To save your acquired or processed images, click on the **Save** or **Save As** button in **File Menu**, or click the  button in the **Main Toolbar** (Fig. 27/1), or click on the  button at the bottom of the **File Handling Area** (Fig. 27/2).

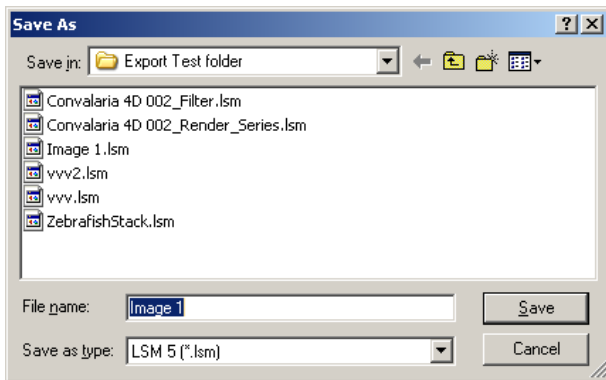


Fig. 28 Save as window

- The WINDOWS **Save As** window appears.
- Enter a file name and choose the appropriate image format. Note: the LSM 5 format is the native Carl Zeiss LSM image data format and contains all available extra information and hardware settings of your experiment.
- Click on the **Save** button.

If you close an image which has not been saved, a pop-up window will ask you if you want to save it. Choosing **yes** will lead you to the WINDOWS **Save As** window.

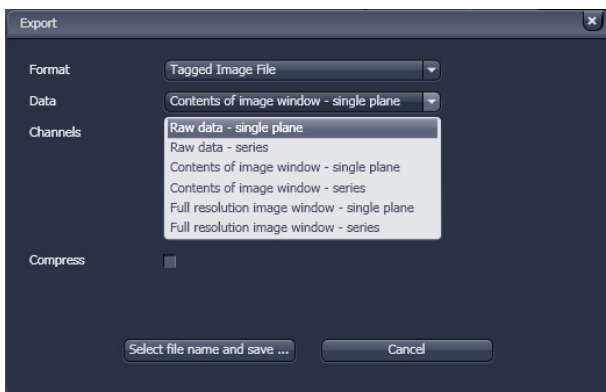
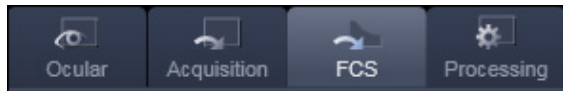


Fig. 29 Export window

To export image display data, a single optical section in raw data format or the contents of the image display window including analysis and overlays, choose **Export** from the **File** menu. In the **Export** window you can select from a number of options and proceed to the WINDOWS **Save As** window to save the exported data to disk.

Using the ConfoCor 3 module

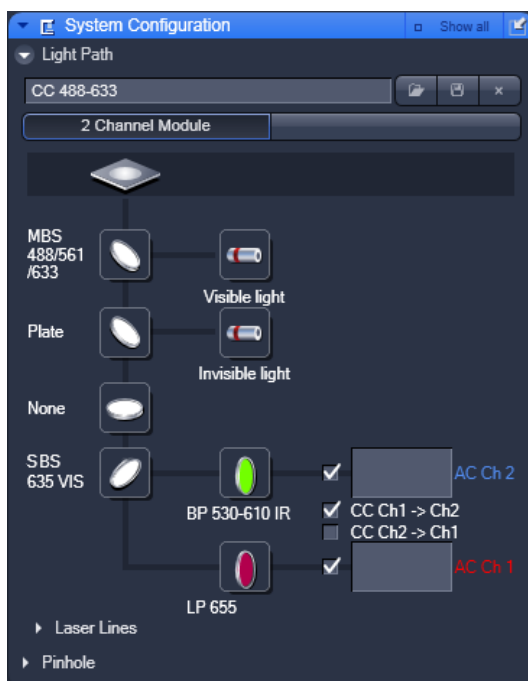


- Click on the **FCS** button.
- Use the **ConfoCor** Tool Group in the **Left Tool Area** to acquire and analyze **FCS** data.



Fig. 30 ConfoCor Tool Group

Setting a configuration



System Configuration

- Open the **System Configuration** tool to define the light path, laser lines and pinhole position.

The **Light Path** and **Pinhole** panels of the **System Configuration** window display the selected track configuration which is used for the FCS procedure and the pinhole size (see Fig. 31).

Fig. 31 The ConfoCor 3 Measure Tool: System Configuration

You can change the settings of this panel using the following function elements:



Activation / deactivation of the excitation wavelengths (check box) and setting of excitation intensities (slider). Open the **Laser Control** tool via the **Laser** icon.



Selection of the main dichroic beam splitter (MBS) or secondary dichroic beam splitter (SBS) position through selection from the relevant list box.



Selection of a block filter through selection from the relevant list box.



Selection of an emission filter through selection from the relevant list box.



Activation / deactivation (via check box) of the selected channel.

- Set the Pinhole diameter (via slider or input box).
- Press the **Count rate** button to open the Real Time display window for the detector **Count rate** in all active channels. Adjust the Laser power In the **Laser Control** panel to obtain a satisfactory count rate.
- Press **Adjust Pinhole** to align the pinhole for each newly defined beam path. After adjusting the sample carrier, align the pinhole automatically in **X** and **Y** by first conducting a coarse and then a fine alignment.

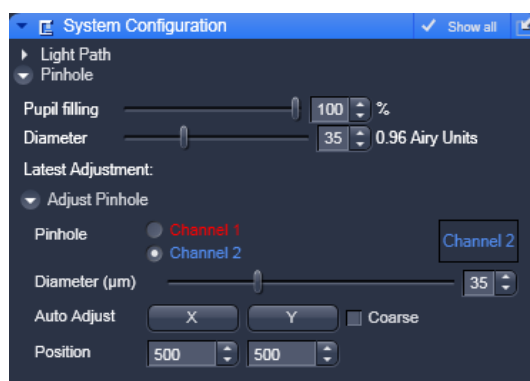


Fig. 32 Pinhole adjustment

Use the **Models** tool to define model equations to which measured data can be fitted.

You have three options to define a model:

- **Correlation:** assemble a correlation model from predefined equations, which will be fitted analytically
- **PCH:** assemble a photon counting histogram model, which will be fitted numerically
- **Formula:** program a user defined model equation, which can be fitted analytically

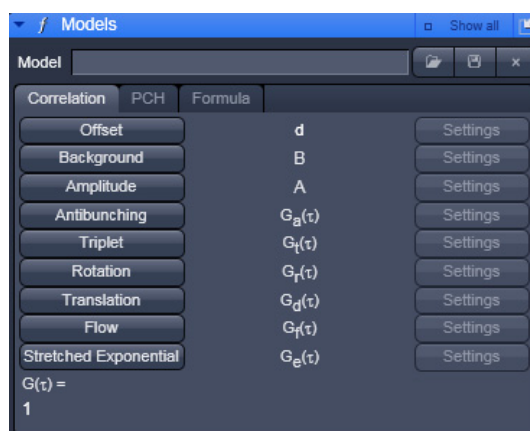


Fig. 33 Models tool

Starting a measurement

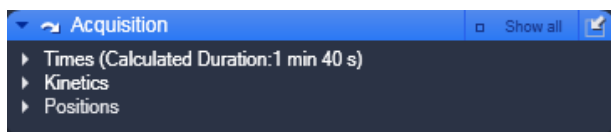


Fig. 34 The ConfoCor 3 Measure Tool: Acquisition

- Select the **Acquisition** toolbar.

The **Times**, **Kinetics** and **Position** panels of the **Acquisition** toolbar display the selected measurement conditions and the positions which are used for the FCS experiment.

You can change the settings of this panel using the following function elements:



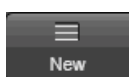
Enter the **Bleach Time**, **Measure Time** and **Repeat Count** into the corresponding input boxes.



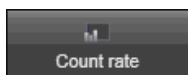
Activate / deactivate a kinetic procedure by ticking the **Use Kinetics** check box. Enter the time distance between measurements, the cycle number and the shape in the corresponding input boxes.



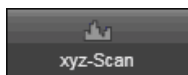
Select the carrier and the sample or laser position by the stage or by the scanners.



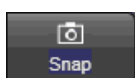
Press the **New** button to open a new **FCS diagram** into an image container. If a measurement is triggered, all data are displayed in that window if highlighted.



Press the **Count rate** button to open the Real Time display window for the detector **Count rate** in all active channels. This allows you to optimize your experiment by changing the laser power and the pinhole size while monitoring the count rate.



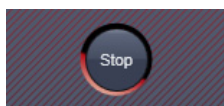
Press the **xyz-Scan** button to display the current coordinates. You can define boundaries where a scan is performed with simultaneous acquisition of the count rate. This allows you, for example, to identify labeled molecules accumulated in the membrane.



Press the **Snap** button to trigger one measurement at the highlighted or first defined position.



Press the **Start ConfoCor Experiment** button to trigger a measurement. All defined positions will be approached consecutively.



Press the **Stop** button to end a measurement. All data accumulated so far will be available and can be stored.

After measurement completion, the data is displayed in the FCS Correlation diagram within an Image Container (see Fig. 35).

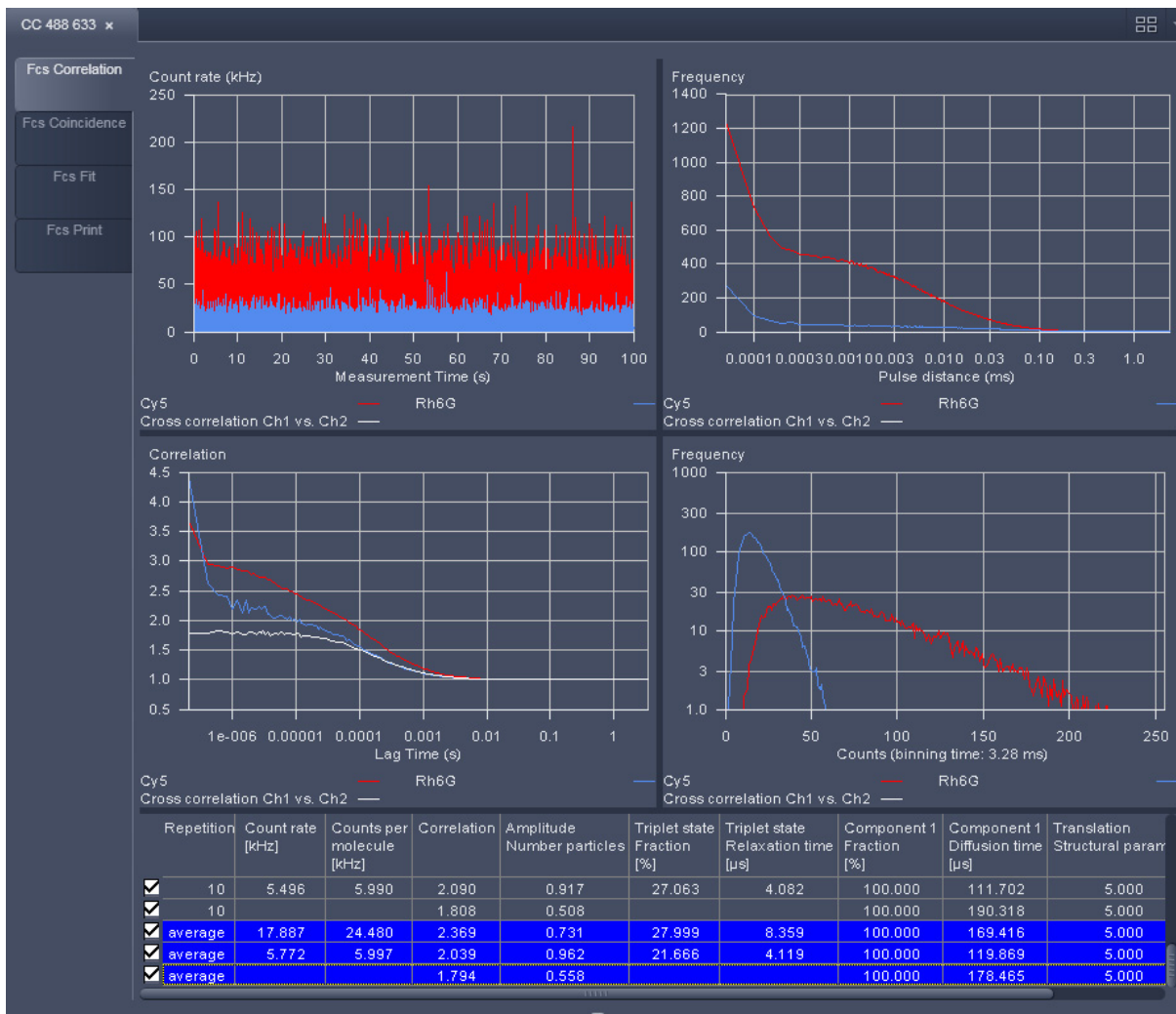


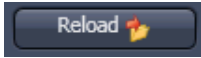
Fig. 35 FCS Correlation diagram

You have the following function elements:

- Fcs Correlation** Activate the **FCS Correlation** panel to display measured data (Fig. 35).
- View Options** Press the **View Options** button to define the graph you want to display.
- Count rate** Press the **Count rate** button to display the count rate trace.
- Correlation** Press the **Correlation** button to display the correlation function.
- Photon counting histogram** Press the **Photon counting histogram** button to display the photon distribution per time unit.
- Data Options** Press the **Data Options** to handle your data.
- Save Data** Press the **Save Data** button to open the **Save** window. You can save the whole data set in an ANSI text format. Optionally you can save the raw data trace if that option was set in the **FCS Options**.



Pressing the **Reuse** button will set the system configuration to exactly the same values, as used in the experiment.



Pressing the **Reload** button will open the current measurement, if stored raw data are available. This allows you to alter the parameters of your mathematical calculations.

Analyzing the data

The acquired FCS data is analyzed in the Fit display of the FCS diagram (see figure Fig. 36).

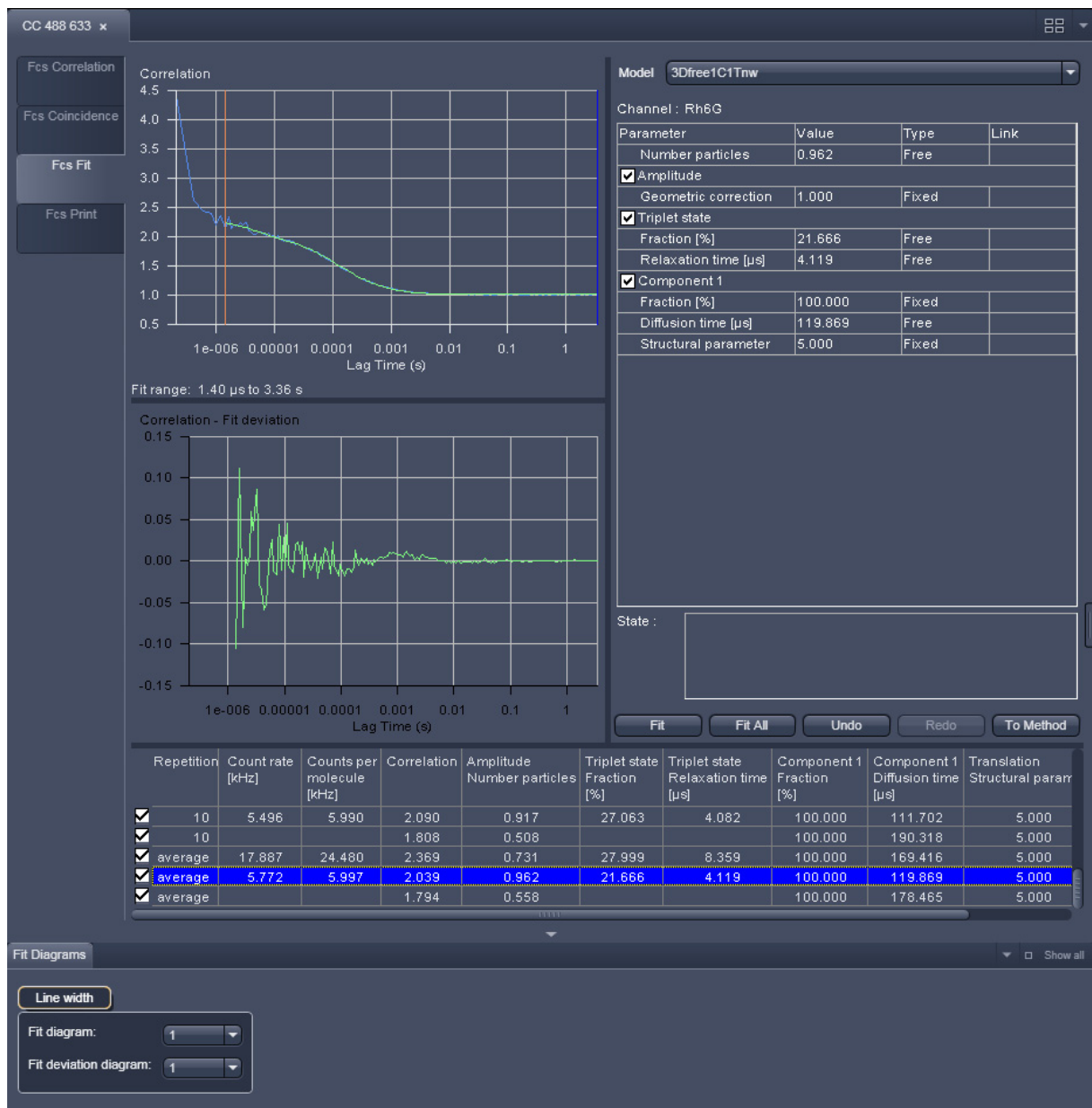
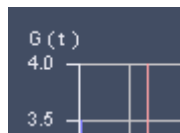


Fig. 36 FCS Fit diagram

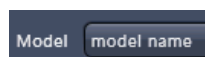
You have the following options:



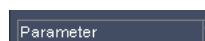
Activate the **FCS Fit** panel to display fitted data (Fig. 36).



Set the red and blue bars to define the start and end points of the curve fit window.



Load a predefined model from the Model drop-down menu. You can assemble a model by pressing the **Model** tool in the **ConfoCor** tool group.



Define the conditions of the fit by activating / deactivating terms, setting the type of a parameter (fixed, free, or start value), defining limits and globally link parameters in the **Model** table.



Pressing the **Fit** button will fit the current loaded correlation functions to the defined model. The fitted data will be displayed in the **Model** and **Result** tables.



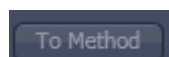
Pressing the **Fit all** button will take all ticked channels and fit them according to the chosen model.



Pressing the **Undo** button will cancel the last operation, or previous ones as well, if the button is pressed repeatedly.



Pressing **Redo** will redo the last cancelled operation, or previous ones, if the button is pressed repeatedly.

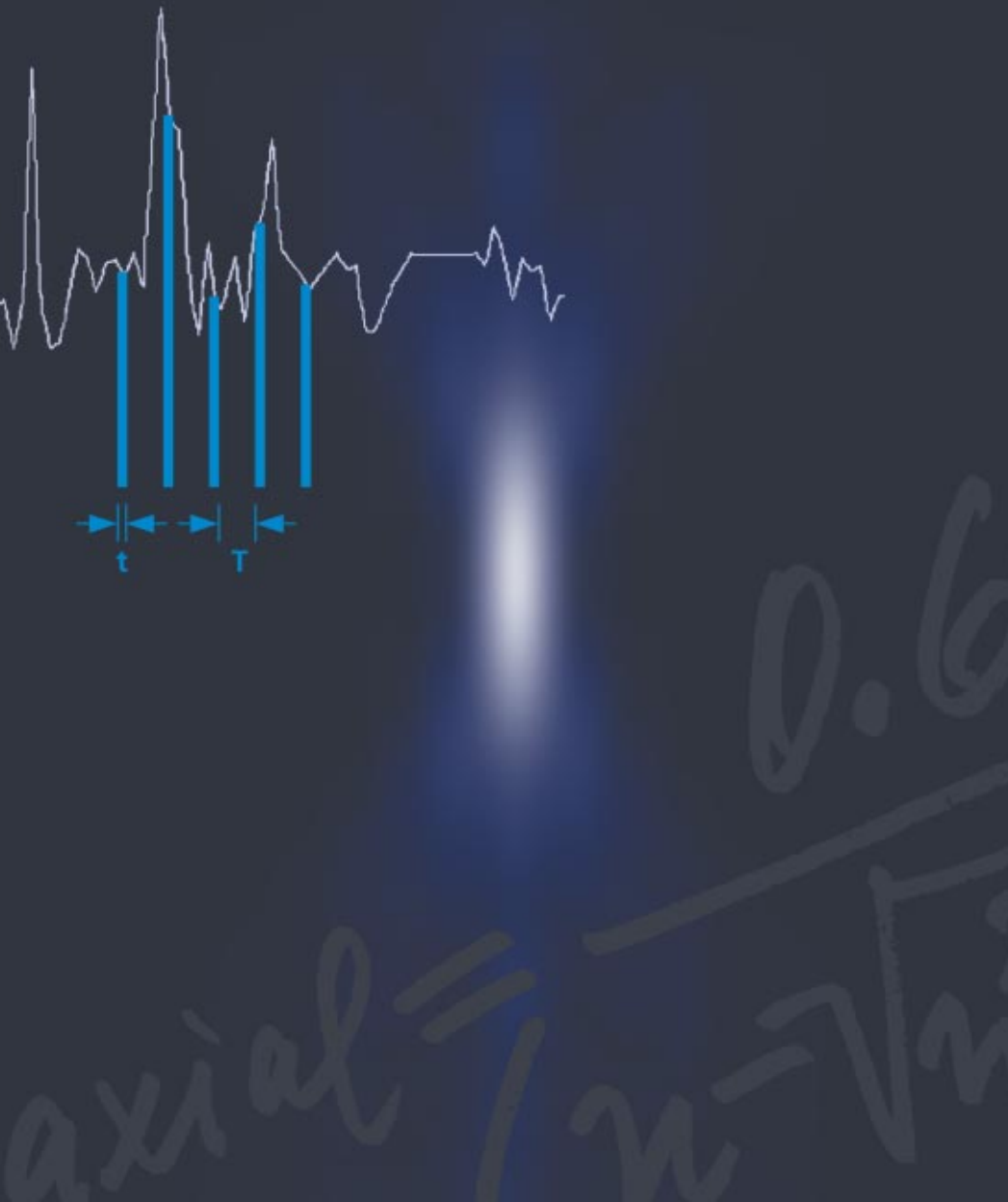


Pressing the **Write to Method** button will write back the settings to the method. If the method is stored, the settings will be active when the method is selected the next time.

Switching off the system

- Click on the **File** button in the **Main Menu** bar and then click on the **Exit** button to leave the **ZEN 2010** software.
- If any lasers are still running you should shut them off now in the pop-up window indicating the lasers still in use.
- Shut down the computer.
- Switch off the Ar-ML laser with first the idle-run-switch (Fig. 2/3) and second the key switch (Fig. 2/1), then wait until the fan of the Argon laser has switched off. Don't switch off the main power yet.
- On the power remote switch turn off the **Components** switch and the **System/PC** switch (Fig. 1).
- Switch off the X-Cite 120 lamp or the HBO 100 mercury burner.
- Switch off the Ar-ML laser of by the main power switch on the power supply (Fig. 2/2).

Confocal Laser Scanning Microscopy



Optical Image Formation
Electronic Signal Processing



Highlights of Laser Scanning Microscopy

1982

The first Laser Scanning Microscope from Carl Zeiss.
The prototype of the LSM 44 series is now on display in the
Deutsches Museum in Munich.



1988

The LSM 10 – a confocal system
with two fluorescence channels.

1991

The LSM 310 combines confocal laser
scanning microscopy with
state-of-the-art computer technology.



1992

The LSM 410 is the first inverted micro-
scope of the LSM family.

1997

The LSM 510 – the first system of the
LSM 5 family and a major breakthrough
in confocal imaging and analysis.



1998

The LSM 510 NLO is ready for multi-
photon microscopy.

1999

The LSM 5 PASCAL –
the personal confocal microscope.

2000

The LSM is combined with
the ConfoCor 2 Fluorescence
Correlation Spectroscopy.



2001

The LSM 510 META –
featuring multispectral analysis.

Confocal Laser Scanning Microscopy

In recent years, the confocal Laser Scanning Microscope (LSM) has become widely established as a research instrument.

The present brochure aims at giving a scientifically sound survey of the special nature of image formation in a confocal LSM.

LSM applications in biology and medicine predominantly employ fluorescence, but it is also possible to use the transmission mode with conventional contrasting methods, such as differential interference contrast (DIC), as well as to overlay the transmission and confocal fluorescence images of the same specimen area.

Another important field of application is materials science, where the LSM is used mostly in the reflection mode and with such methods as polarization.

Confocal microscopes are even used in routine quality inspection in industry. Here, confocal images provide an efficient way to detect defects in semiconductor circuits.

Contents

Introduction	2
---------------------	----------

Part 1 **Optical Image Formation**

Point Spread Function	6
Resolution and Confocality	8
Resolution	9
Geometric optic confocality	10
Wave-optical confocality	12
Overview	15

Part 2 **Signal Processing**

Sampling and Digitization	16
Types of A/D conversion	17
Nyquist theorem	18
Pixel size	19
Noise	20
Resolution and shot noise – resolution probability	21
Possibilities to improve SNR	23
Summary	25
Glossary	26

Details

Pupil Illumination	I
Optical Coordinates	II
Fluorescence	III
Sources of Noise	V

Literature

Following a description of the fundamental differences between a conventional and a confocal microscope, this monograph will set out the special features of the confocal LSM and the capabilities resulting from them.

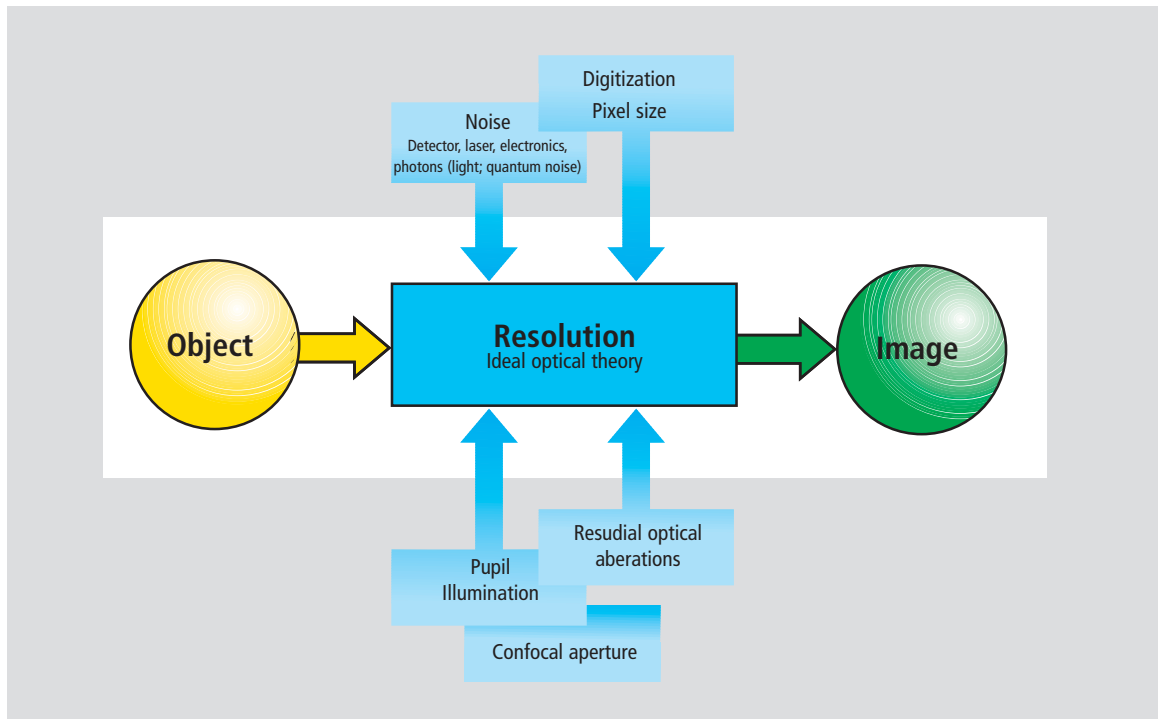
The conditions in fluorescence applications will be given priority treatment throughout.

Image generation

The complete generation of the two-dimensional object information from the focal plane (object plane) of a confocal LSM essentially comprises three process steps:

1. Line-by-line scanning of the specimen with a focused laser beam deflected in the X and Y directions by means of two galvanometric scanners.
2. Pixel-by-pixel detection of the fluorescence emitted by the scanned specimen details, by means of a photomultiplier tube (PMT).
3. Digitization of the object information contained in the electrical signal provided by the PMT (for presentation, the image data are displayed, pixel by pixel, from a digital matrix memory to a monitor screen).

Fig.1 The quality of the image generated in a confocal LSM is not only influenced by the optics (as in a conventional microscope), but also, e.g., by the confocal aperture (pinhole) and by the digitization of the object information (pixel size). Another important factor is noise (laser noise, or the shot noise of the fluorescent light). To minimize noise, signal-processing as well as optoelectronic and electronic devices need to be optimized.



Introduction

Scanning process

In a conventional light microscope, object-to-image transformation takes place simultaneously and parallel for all object points. By contrast, the specimen in a confocal LSM is irradiated in a point-wise fashion, i.e. serially, and the physical interaction between the laser light and the specimen detail irradiated (e.g. fluorescence) is measured point by point. To obtain information about the entire specimen, it is necessary to guide the laser beam across the specimen, or to move the specimen relative to the laser beam, a process known as scanning. Accordingly, confocal systems are also known as point-probing scanners.

To obtain images of microscopic resolution from a confocal LSM, a computer and dedicated software are indispensable.

The descriptions below exclusively cover the point scanner principle as implemented, for example, in Carl Zeiss laser scanning microscopes. Configurations in which several object points are irradiated simultaneously are not considered.

Confocal beam path

The decisive design feature of a confocal LSM compared with a conventional microscope is the confocal aperture (usually called pinhole) arranged in a plane conjugate to the intermediate image plane and, thus, to the object plane of the microscope. As a result, the detector (PMT) can only detect light that has passed the pinhole. The pinhole diameter is variable; ideally, it is infinitely small, and thus the detector looks at a point (point detection).

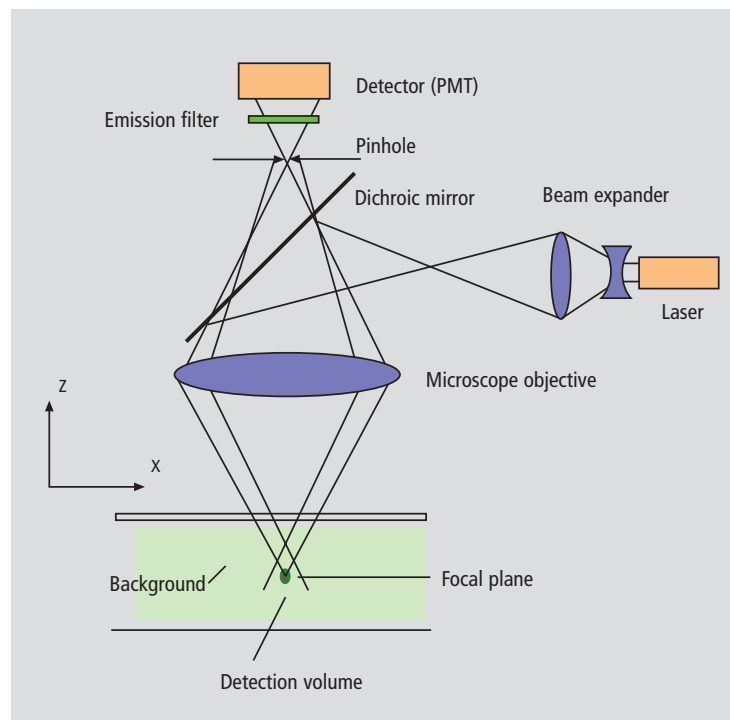
As the laser beam is focused to a diffraction-limited spot, which illuminates only a point of the object at a time, the point illuminated and the point observed (i.e. image and object points) are situated in conjugate planes, i.e. they are focused onto each other. The result is what is called a confocal beam path (see figure 2).

Pinhole

Depending on the diameter of the pinhole, light coming from object points outside the focal plane is more or less obstructed and thus excluded from detection. As the corresponding object areas are invisible in the image, the confocal microscope can be understood as an inherently depth-discriminating optical system.

By varying the pinhole diameter, the degree of confocality can be adapted to practical requirements. With the aperture fully open, the image is nonconfocal. As an added advantage, the pinhole suppresses stray light, which improves image contrast.

Fig. 2 Beam path in a confocal LSM. A microscope objective is used to focus a laser beam onto the specimen, where it excites fluorescence, for example. The fluorescent radiation is collected by the objective and efficiently directed onto the detector via a dichroic beamsplitter. The interesting wavelength range of the fluorescence spectrum is selected by an emission filter, which also acts as a barrier blocking the excitation laser line. The pinhole is arranged in front of the detector, on a plane conjugate to the focal plane of the objective. Light coming from planes above or below the focal plane is out of focus when it hits the pinhole, so most of it cannot pass the pinhole and therefore does not contribute to forming the image.

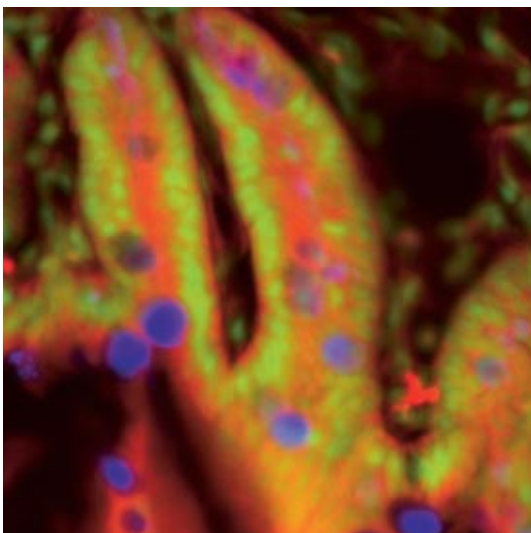


Optical slices

With a confocal LSM it is therefore possible to exclusively image a thin optical slice out of a thick specimen (typically, up to 100 μm), a method known as optical sectioning. Under suitable conditions, the thickness (Z dimension) of such a slice may be less than 500 nm.

The fundamental advantage of the confocal LSM over a conventional microscope is obvious: In conventional fluorescence microscopy, the image of a thick biological specimen will only be in focus if its Z dimension is not greater than the wave-optical depth of focus specified for the respective objective.

Unless this condition is satisfied, the in-focus image information from the object plane of interest is mixed with out-of focus image information from planes outside the focal plane. This reduces image contrast and increases the share of stray light detected. If multiple fluorescences are observed, there will in addition be a color mix of the image information obtained from the channels involved (figure 3, left).

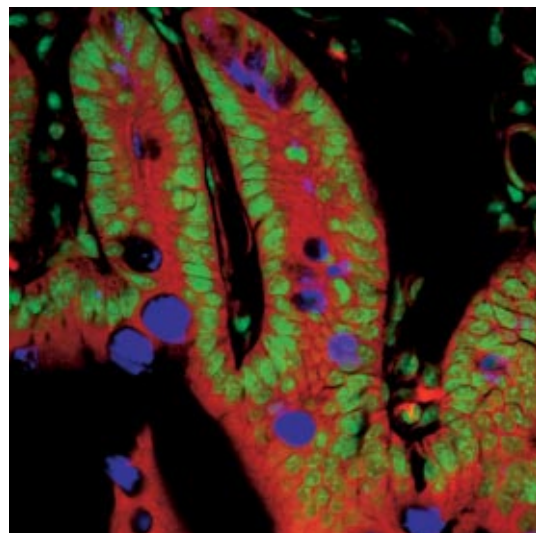


A confocal LSM can therefore be used to advantage especially where thick specimens (such as biological cells in tissue) have to be examined by fluorescence. The possibility of optical sectioning eliminates the drawbacks attached to the observation of such specimens by conventional fluorescence microscopy. With multicolor fluorescence, the various channels are satisfactorily separated and can be recorded simultaneously.

With regard to reflective specimens, the main application is the investigation of the topography of 3D surface textures.

Figure 3 demonstrates the capability of a confocal Laser Scanning Microscope.

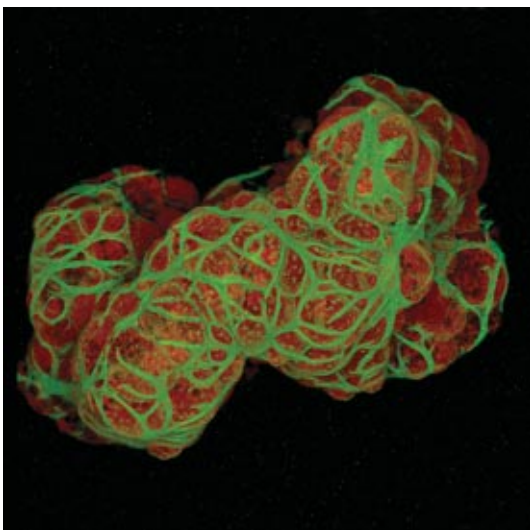
Fig. 3 Non-confocal (left) and confocal (right) image of a triple-labeled cell aggregate (mouse intestine section). In the non-confocal image, specimen planes outside the focal plane degrade the information of interest from the focal plane, and differently stained specimen details appear in mixed color. In the confocal image (right), specimen details blurred in non-confocal imaging become distinctly visible, and the image throughout is greatly improved in contrast.



3rd dimension

In addition to the possibility to observe a single plane (or slice) of a thick specimen in good contrast, optical sectioning allows a great number of slices to be cut and recorded at different planes of the specimen, with the specimen being moved along the optical axis (Z) by controlled increments. The result is a 3D data set, which provides information about the spatial structure of the object. The quality and accuracy of this information depend on the thickness of the slice and on the spacing between successive slices (optimum scanning rate in Z direction = 0.5x the slice thickness). By computation, various aspects of the object can be generated from the 3D data set (3D reconstruction, sections of any spatial orientation, stereo pairs etc.). Figure 4 shows a 3D reconstruction computed from a 3D data set.

Fig. 4 3D projection reconstructed from 108 optical slices of a three-dimensional data set of epithelium cells of a lacrimal gland. Actin filaments of myoepithelial cells marked with BODIPY-FL phalloidin (green), cytoplasm and nuclei of acinar cells with ethidium homodimer-1 (red).



Time series

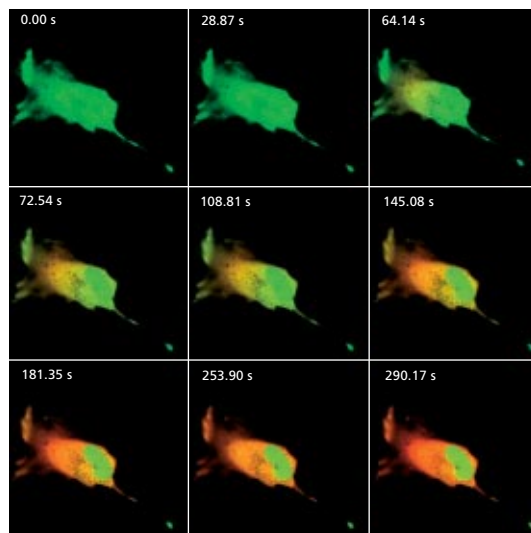
A field of growing importance is the investigation of living specimens that show dynamic changes even in the range of microseconds. Here, the acquisition of time-resolved confocal image series (known as time series) provides a possibility of visualizing and quantifying the changes.

The following section (Part 1, page 6 ff) deals with the purely optical conditions in a confocal LSM and the influence of the pinhole on image formation. From this, ideal values for resolution and optical slice thickness are derived.

Part 2, page 16 ff limits the idealized view, looking at the digitizing process and the noise introduced by the light as well as by the optoelectronic components of the system.

The table on page 15 provides a summary of the essential results of Part 1. A schematic overview of the entire content and its practical relevance is given on the poster inside this brochure.

Fig. 5 Gallery of a time series experiment with Kaede-transfected cells. By repeated activation of the Kaede marker (green-to-red color change) in a small cell region, the entire green fluorescence is converted step by step into the red fluorescence.



Point Spread Function

In order to understand the optical performance characteristics of a confocal LSM in detail, it is necessary to have a closer look at the fundamental optical phenomena resulting from the geometry of the confocal beam path. As mentioned before, what is most essential about a confocal LSM is that both illumination and observation (detection) are limited to a point.

Not even an optical system of diffraction-limited design can image a truly point-like object as a point. The image of an ideal point object will always be somewhat blurred, or “spread” corresponding to the imaging properties of the optical system. The image of a point can be described in quantitative terms by the point spread function (PSF), which maps the intensity distribution in the image space.

Where the three-dimensional imaging properties of a confocal LSM are concerned, it is necessary to consider the 3D image or the 3D-PSF.

In the ideal, diffraction-limited case (no optical aberrations, homogeneous illumination of the pupil – see *Details “Pupil Illumination”*), the 3D-PSF is of comet-like, rotationally symmetrical shape.

For illustration, Figure 6 shows two-dimensional sections (XZ and XY) through an ideal 3D-PSF.

From the illustration it is evident that the central maximum of the 3D-PSF, in which 86.5 % of the total energy available in the pupil are concentrated, can be described as an ellipsoid of rotation. For considerations of resolution and optical slice thickness it is useful to define the half-maximum area of the ellipsoid of rotation, i.e. the well-defined area in which the intensity of the 3D point image in axial and lateral directions has dropped to half of the central maximum.

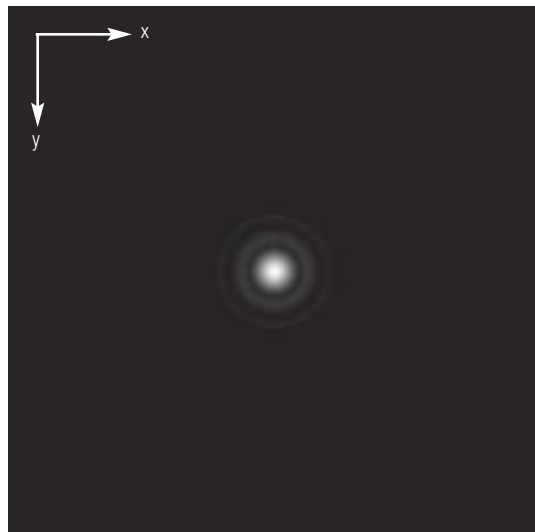
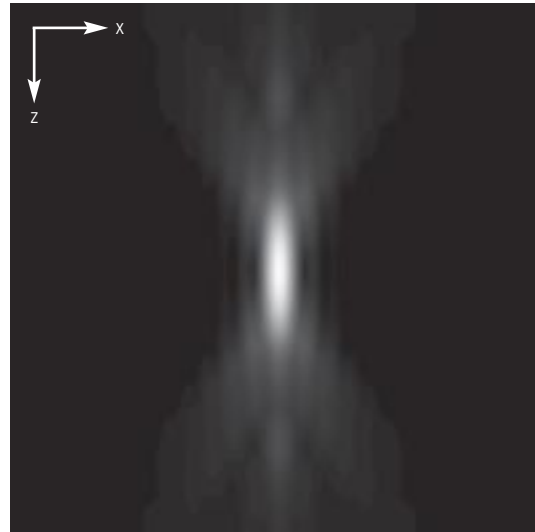


Fig. 6 Section through the 3D-PSF in Z direction – top, and in XY-direction – bottom (computed; dimensionless representation); the central, elliptical maximum is distinctly visible. The central maximum in the bottom illustration is called Airy disk and is contained in the 3D-PSF as the greatest core diameter in lateral direction.

Any reference to the PSF in the following discussion exclusively refers to the half-maximum area. Quantitatively the half-maximum area is described in terms of the full width at half maximum (FWHM), a lateral or axial distance corresponding to a 50% drop in intensity.

The total PSF (PSF_{tot}) of a confocal microscope behind the pinhole is composed of the PSFs of the illuminating beam path (PSF_{ill} ; point illumination) and the detection beam path (PSF_{det} ; point detection). Accordingly, the confocal LSM system as a whole generates two point images: one by projecting a point light source into the object space, the other by projecting a point detail of the object into the image space. Mathematically, this relationship can be described as follows:

$$PSF_{tot}(x,y,z) = PSF_{ill}(x,y,z) \cdot PSF_{det}(x,y,z) \quad (1)$$

PSF_{ill} corresponds to the light distribution of the laser spot that scans the object. Its size is mainly a function of the laser wavelength and the numerical aperture of the microscope objective. It is also influenced by diffraction at the objective pupil (as a function of pupil illumination) and the aberrations of all optical components integrated in the system. [Note: In general, these aberrations are low, having been minimized during system design].

Moreover, PSF_{ill} may get deformed if the laser focus enters thick and light-scattering specimens, especially if the refractive indices of immersion liquid and mounting medium are not matched and/or if the laser focus is at a great depth below the specimen surface (see Hell, S., et al., [9]).

PSF_{det} is also influenced by all these factors and, additionally, by the pinhole size. For reasons of beam path efficiency (see Part 2), the pinhole is never truly a point of infinitely small size and thus PSF_{det} is never smaller in dimension than PSF_{ill} . It is evident that the imaging properties of a confocal LSM are determined by the interaction between PSF_{ill} and PSF_{det} . As a consequence of the interaction process, $PSF_{tot} \leq PSF_{ill}$.

With the pinhole diameter being variable, the effects obtained with small and big pinhole diameters must be expected to differ.

In the following sections, various system states are treated in quantitative terms.

From the explanations made so far, it can also be derived that the optical slice is not a sharply delimited body. It does not start abruptly at a certain Z position, nor does it end abruptly at another. Because of the intensity distribution along the optical axis, there is a continuous transition from object information suppressed and such made visible.

Accordingly, the out-of-focus object information actually suppressed by the pinhole also depends on the correct setting of the image processing parameters (PMT high voltage, contrast setting). Signal overdrive or excessive offset should be avoided.

Resolution and Confocality

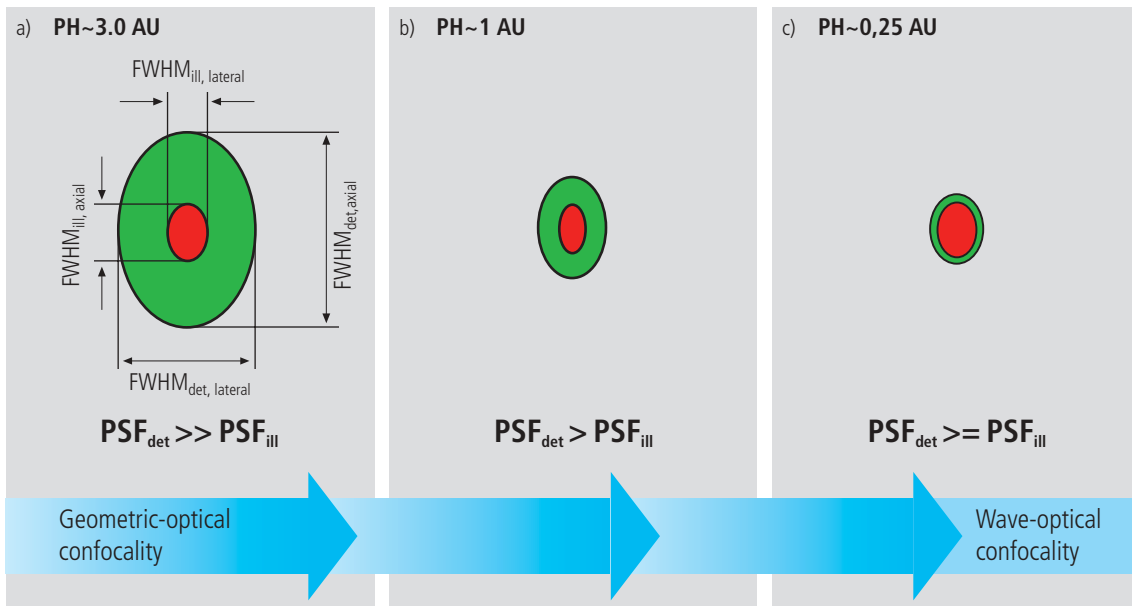
Wherever quantitative data on the resolving power and depth discrimination of a confocal LSM are specified, it is necessary to distinguish clearly whether the objects they refer to are point-like or extended, and whether they are reflective or fluorescent. These differences involve distinctly varying imaging properties. Fine structures in real biological specimens are mainly of a filiform or point-like fluorescent type, so that the explanations below are limited to point-like fluorescent objects. The statements made for this case are well applicable to practical assignments. As already mentioned, the pinhole diameter plays a decisive role in resolution and depth discrimination. With a pinhole diameter greater than 1 AU (AU = Airy unit – see *Details "Optical Coordinates"*), the depth discriminating properties under consideration are essentially based on the law of geometric optics (geometric-optical confocality).

The smaller the pinhole diameter, the more PSF_{det} approaches the order of magnitude of PSF_{ill} . In the limit case ($PH < 0.25$ AU), both PSFs are approximately equal in size, and wave-optical image formation laws clearly dominate (wave-optical confocality).

Figure 7 illustrates these concepts. It is a schematic representation of the half-intensity areas of PSF_{ill} and PSF_{det} at selected pinhole diameters.

Depending on which kind of confocality dominates, the data and computation methods for resolution and depth discrimination differ. A comparison with image formation in conventional microscopes is interesting as well. The following sections deal with this in detail.

Fig. 7 Geometric-optical (a) and wave-optical confocality (c) [XZ view]. The pinhole diameter decreases from (a) to (c). Accordingly, PSF_{det} shrinks until it approaches the order of magnitude of PSF_{ill} (c).



Resolution

Resolution, in case of large pinhole diameters ($PH > 1 AU$), is meant to express the separate visibility, both laterally and axially, of points during the scanning process. Imagine an object consisting of individual points: all points spaced closer than the extension of PSF_{ill} are blurred (spread), i.e. they are not resolved.

Quantitatively, resolution results from the axial and lateral extension of the scanning laser spot, or the elliptical half-intensity area of PSF_{ill} . On the assumption of homogeneous pupil illumination, the following equations apply:

Axial:

$$FWHM_{ill,axial} = \frac{0.88 \cdot \lambda_{exc}}{(n - \sqrt{n^2 - NA^2})} \quad (2)$$

n = refractive index of immersion liquid,
 NA = numerical aperture of the microscope objective,
 λ_{exc} = wavelength of the excitation light

If $NA < 0.5$, equation (2) can be approximated by:

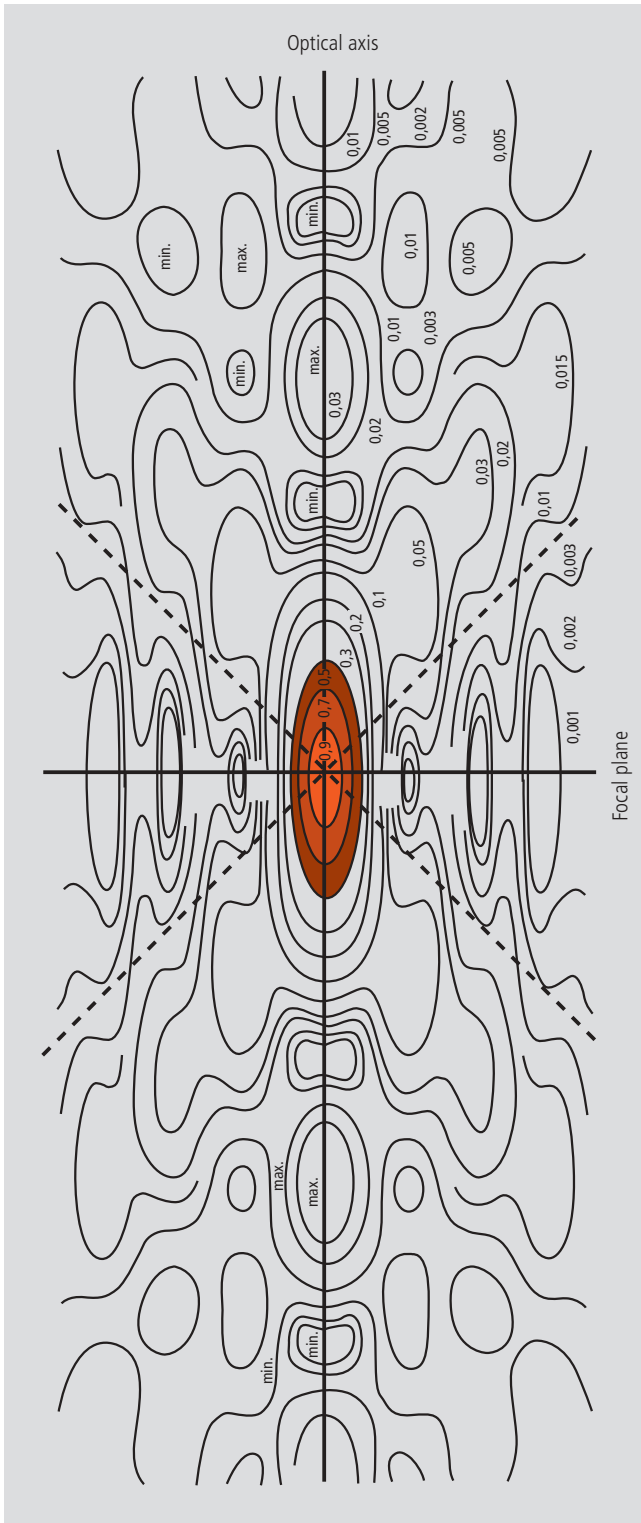
$$\approx \frac{1.77 \cdot n \cdot \lambda_{exc}}{NA^2} \quad (2a)$$

Lateral:

$$FWHM_{ill,lateral} = 0.51 \frac{\lambda_{exc}}{NA} \quad (3)$$

At first glance, equations (2a) and (3) are not different from those known for conventional imaging (see Beyer, H., [3]). It is striking, however, that the resolving power in the confocal microscope depends only on the wavelength of the illuminating light, rather than exclusively on the emission wavelength as in the conventional case.

Compared to the conventional fluorescence microscope, confocal fluorescence with large pinhole diameters leads to a gain in resolution by the factor $(\lambda_{em}/\lambda_{exc})$ via the Stokes shift.



Let the statements made on PSF so far be further illustrated by the figure on the left. It shows a section through the resulting diffraction pattern surrounding the focus on the illumination side (PSF_{III}). The lines include areas of equal brightness (isophote presentation). The center has a normalized intensity of 1. The real relationships result by rotation of the section about the vertical (Z) axis. Symmetry exists relative to the focal plane as well as to the optical axis. Local intensity maxima and minima are conspicuous. The dashed lines mark the range covered by the aperture angle of the microscope objective used.

For the considerations in this chapter, only the area inside the red line, i.e. the area at half maximum, is of interest.

Fig. 8 Isophote diagram of the intensity distribution around the illumination-side focus (PSF_{III}). The intensity at the focus is normalized as 1. (Born & Wolf, Principles of Optics, 6th edition 1988, Pergamon Press)

Geometric optical confocality

Optical slice thickness (depth discrimination) and stray light suppression (contrast improvement) are basic properties of a confocal LSM, even if the pinhole diameter is not an ideal point (i.e. not infinitely small). In this case, both depth discrimination and stray light suppression are determined exclusively by PSF_{det} . This alone brings an improvement in the separate visibility of object details over the conventional microscope.

Hence, the diameter of the corresponding half-intensity area and thus the optical slice thickness is given by:

$$FWHM_{det,axial} = \sqrt{\left(\frac{0.88 \cdot \lambda_{em}}{n \cdot \sqrt{n^2 - NA^2}}\right)^2 + \left(\frac{\sqrt{2} \cdot n \cdot PH}{NA}\right)^2} \quad (4)$$

- λ_{em} = emission wavelength
- PH = object-side pinhole diameter [μm]
- n = refractive index of immersion liquid
- NA = numerical aperture of the objective

Equation (4) shows that the optical slice thickness comprises a geometric-optical and a wave-optical term. The wave-optical term (first term under the root) is of constant value for a given objective and a given emission wavelength. The geometric-optical term (second term under the root) is dominant; for a given objective it is influenced exclusively by the pinhole diameter.

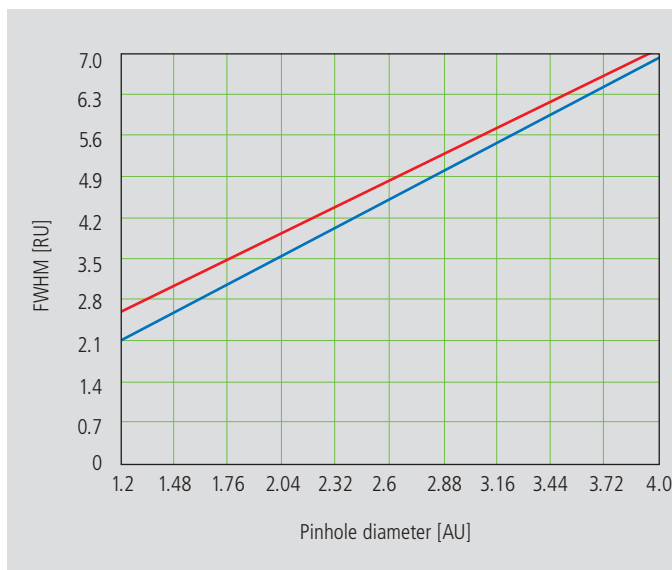
Likewise, in the case of geometric-optical confocality, there is a linear relationship between depth discrimination and pinhole diameter. As the pinhole diameter is constricted, depth discrimination improves (i.e. the optical slice thickness decreases). A graphical representation of equation (4) is illustrated in figure 9. The graph shows the geometric-optical term alone (blue line) and the curve resulting from eq. 4 (red line). The difference between the two curves is a consequence of the wave-optical term.

Above a pinhole diameter of 1 AU, the influence of diffraction effects is nearly constant and equation (4) is a good approximation to describe the depth discrimination. The interaction between PSF_{ill} and PSF_{det} becomes manifest only with pinhole diameters smaller than 1 AU.

Let it be emphasized that in case of geometric optical confocality the diameters of the half-intensity area of PSF_{det} allow no statement about the separate visibility of object details in axial and lateral direction.

In the region of the optical section ($FWHM_{det,axial}$), object details are resolved (imaged separately) only unless they are spaced not closer than described by equations (2) / (2a) / (3).

Fig.9 Optical slice thickness as a function of the pinhole diameter (red line). Parameters: $NA = 0.6$; $n = 1$; $\lambda = 520 \text{ nm}$. The X axis is dimensioned in Airy units, the Y axis (slice thickness) in Rayleigh units (see also: Details "Optical Coordinates"). In addition, the geometric-optical term in equation 4 is shown separately (blue line).



Wave-optical confocality

If the pinhole is closed down to a diameter of <0.25 AU (virtually "infinitely small"), the character of the image changes. Additional diffraction effects at the pinhole have to be taken into account, and PSF_{det} (optical slice thickness) shrinks to the order of magnitude of PSF_{ill} (Z resolution) (see also figure 7c).

In order to achieve simple formulae for the range of smallest pinhole diameters, it is practical to regard the limit of $PH = 0$ at first, even though it is of no practical use. In this case, PSF_{det} and PSF_{ill} are identical.

The total PSF can be written as

$$PSF_{tot}(x,y,z) = (PSF_{ill}(x,y,z))^2 \quad (5)$$

In fluorescence applications it is furthermore necessary to consider both the excitation wavelength λ_{exc} and the emission wavelength λ_{em} . This is done by specifying a mean wavelength¹:

$$\bar{\lambda} \approx \sqrt{2} \frac{\lambda_{em} \cdot \lambda_{exc}}{\sqrt{\lambda_{exc}^2 + \lambda_{em}^2}} \quad (6)$$

Thus, equations (2) and (3) for the widths of the axial and lateral half-intensity areas are transformed into:

Axial:

$$FWHM_{tot,axial} = \frac{0.64 \cdot \bar{\lambda}}{(n - \sqrt{n^2 - NA^2})} \quad (7)$$

If $NA < 0.5$, equation (7) can be approximated by

$$\approx \frac{1.28 \cdot n \cdot \bar{\lambda}}{NA^2} \quad (7a)$$

Lateral:

$$FWHM_{tot,lateral} = 0.37 \frac{\bar{\lambda}}{NA} \quad (8)$$

Note:

With the object being a mirror, the factor in equation 7 is 0.45 (instead of 0.64), and 0.88 (instead of 1.28) in equation 7a. For a fluorescent plane of finite thickness, a factor of 0.7 can be used in equation 7. This underlines that apart from the factors influencing the optical slice thickness, the type of specimen also affects the measurement result.

¹ For rough estimates, the expression $\bar{\lambda} \approx \sqrt{\lambda_{em} \cdot \lambda_{exc}}$ suffices.

From equations (7) and (7a) it is evident that depth resolution varies linearly with the refractive index n of the immersion liquid and with the square of the inverse value of the numerical aperture of the objective $\{NA = n \cdot \sin(\alpha)\}$.

To achieve high depth discrimination, it is important, above all, to use objectives with the highest possible numerical aperture.

As an $NA > 1$ can only be obtained with an immersion liquid, confocal fluorescence microscopy is usually performed with immersion objectives (see also figure 11).

A comparison of the results stated before shows that axial and lateral resolution in the limit of $PH=0$ can be improved by a factor of 1.4. Furthermore it should be noted that, because of the wave-optical relationships discussed, the optical performance of a confocal LSM cannot be enhanced infinitely. Equations (7) and (8) supply the minimum possible slice thickness and the best possible resolution, respectively.

From the applications point of view, the case of strictly wave-optical confocality ($PH=0$) is irrelevant (see also Part 2).

By merely changing the factors in equations (7) and (8) it is possible, though, to transfer the equations derived for $PH=0$ to the pinhole diameter range up to 1 AU, to a good approximation. The factors applicable to particular pinhole diameters can be taken from figure 10.

It must also be noted that with $PH < 1AU$, a distinction between optical slice thickness and resolution can no longer be made. The thickness of the optical slice at the same time specifies the resolution properties of the system. That is why in the literature the term of depth resolution is frequently used as a synonym for depth discrimination or optical slice thickness. However, this is only correct for pinhole diameters smaller than 1 AU.

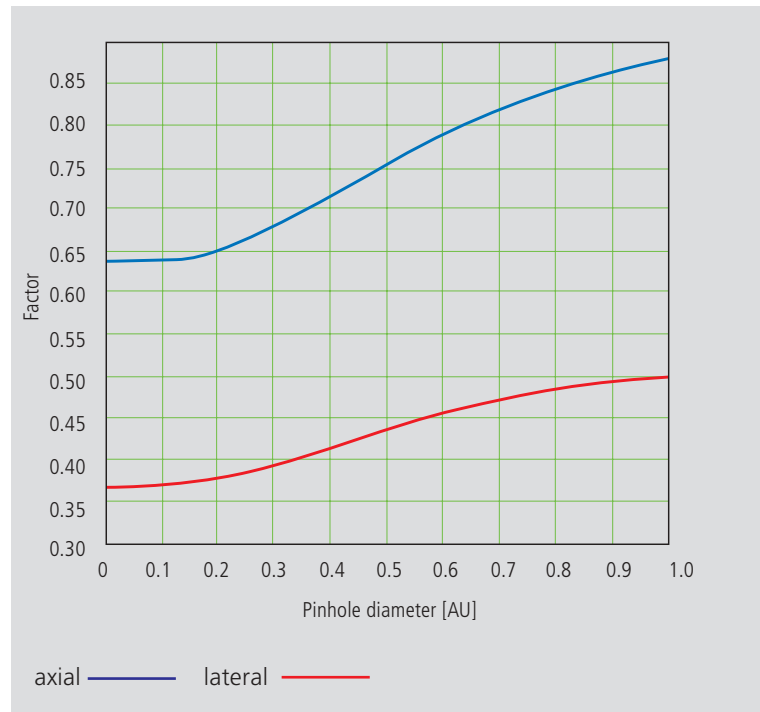


Fig. 10 Theoretical factors for equations (7) and (8), with pinhole diameters between 0 and 1 AU.

To conclude the observations about resolution and depth discrimination (or depth resolution), the table on page 15 provides an overview of the formula relationships developed in Part 1. In addition, figure 11a shows the overall curve of optical slice thickness for a microscope objective of $NA = 1.3$ and $n = 1.52$ ($\bar{\lambda} = 496$ nm).

In figure 11b-d, equation (7) is plotted for different objects and varied parameters ($NA, \bar{\lambda}, n$).

Optical slice
 (NA = 1.3; n = 1.52;
 $\bar{\lambda}$ = 496 nm)

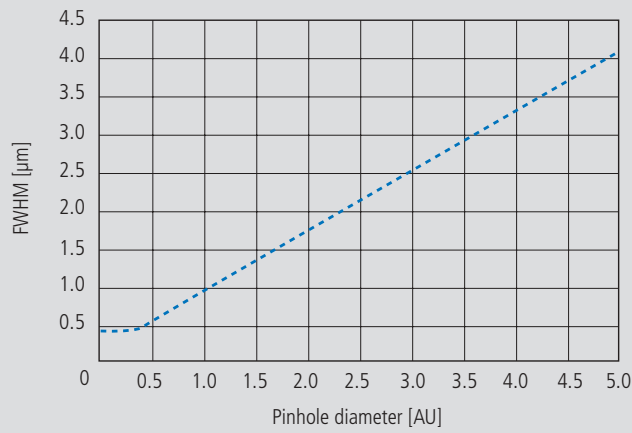
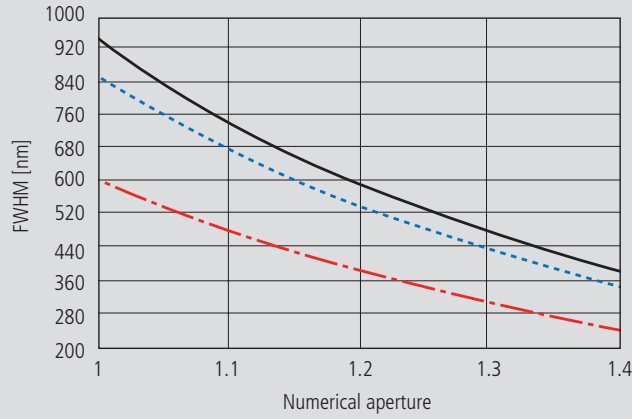


Fig. 11

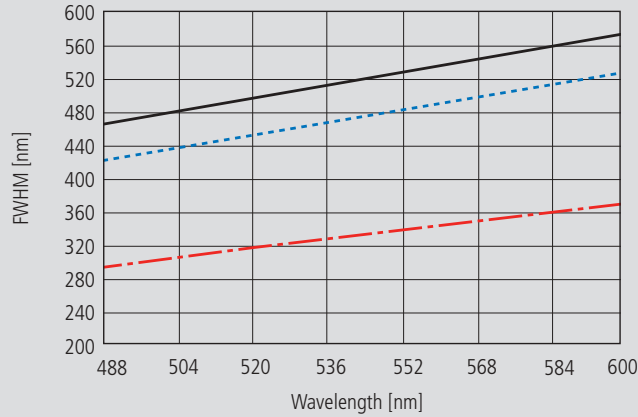
a) Variation of pinhole diameter

Depth resolution
 (PH = 0; n = 1.52;
 $\bar{\lambda}$ = 496 nm)



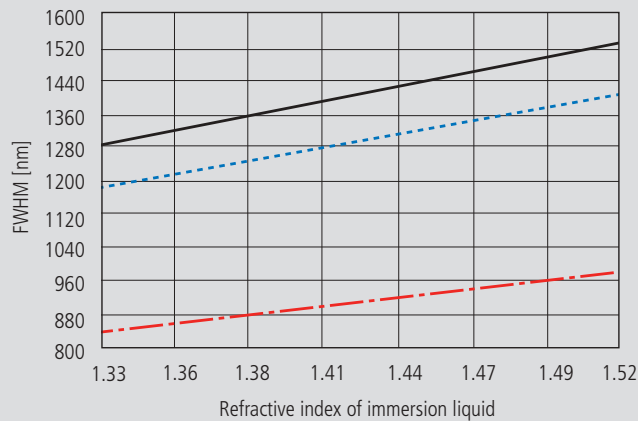
b) Variation of numerical aperture

Depth resolution
 (PH = 0; NA = 1.3; n = 1.52)



c) Variation of wavelength ($\bar{\lambda}$)

Depth resolution
 (PH = 0; NA = 0.8;
 $\bar{\lambda}$ = 496 nm)



d) Variation of refractive index

— fluorescent plane
 fluorescent point
 - · - reflecting plane (mirror)

Overview

Conventional microscopy	Confocal microscopy 1 AU < PH < ∞	Confocal microscopy PH < 0.25 AU
<p>1. Optical slice thickness not definable</p> <p>With a conventional microscope, unlike in confocal microscopy, sharply defined images of “thick” biological specimens can only be obtained if their Z dimension is not greater than the wave-optical depth of field specified for the objective used. Depending on specimen thickness, object information from the focal plane is mixed with blurred information from out-of-focus object zones.</p> <p>Optical sectioning is not possible; consequently, no formula for optical slice thickness can be given.</p>	<p>1. Optical slice thickness¹⁾</p> $\sqrt{\left(\frac{0.88 \cdot \lambda_{em}}{n \cdot \sqrt{n^2 - NA^2}}\right)^2 + \left(\frac{\sqrt{2} \cdot n \cdot PH}{NA}\right)^2}$ <p>Corresponds to the FWHM of the intensity distribution behind the pinhole (PSF_{det}). The FWHM results from the emission-side diffraction pattern and the geometric-optical effect of the pinhole. Here, PH is the variable object-side pinhole diameter in μm.</p>	<p>1. Optical slice thickness</p> $\frac{0.64 \cdot \bar{\lambda}}{(n \cdot \sqrt{n^2 - NA^2})}$ <p>The term results as the FWHM of the total PSF – the pinhole acts according to wave optics. $\bar{\lambda}$ stands for a mean wavelength – see the text body above for the exact definition. The factor 0.64 applies only to a fluorescent point object.</p>
<p>2. Axial resolution (wave-optical depth of field)</p> $\frac{n \cdot \lambda_{em}}{NA^2}$ <p>Corresponds to the width of the emission-side diffraction pattern at 80% of the maximum intensity, referred to the object plane. In the literature, the wave-optical depth of field in a conventional microscope is sometimes termed depth resolution. However, a clear distinction should be made between the terms resolution and depth resolution.</p>	<p>2. Axial resolution</p> $\frac{0.88 \cdot \lambda_{exc}}{(n \cdot \sqrt{n^2 - NA^2})}$ <p>FWHM of PSF_{III} (intensity distribution at the focus of the microscope objective) in Z direction.</p> <p>No influence by the pinhole.</p>	<p>2. Axial resolution</p> $\frac{0.64 \cdot \bar{\lambda}}{(n \cdot \sqrt{n^2 - NA^2})}$ <p>FWHM of total PSF in Z direction</p> <p>As optical slice thickness and resolution are identical in this case, depth resolution is often used as a synonym.</p>
<p>3. For comparison: FWHM of PSF in the intermediate image (Z direction) – referred to the object plane.</p> $\frac{1.77 \cdot n \cdot \lambda_{em}}{NA^2}$	<p>3. Approximation to 2. for NA < 0.5</p> $\frac{1.77 \cdot n \cdot \lambda_{exc}}{NA^2}$	<p>3. Approximation to 2. for NA < 0.5</p> $\frac{1.28 \cdot n \cdot \bar{\lambda}}{NA^2}$
<p>4. Lateral resolution</p> $\frac{0.51 \cdot \lambda_{em}}{NA}$ <p>FWHM of the diffraction pattern in the intermediate image – referred to the object plane) in X/Y direction.</p>	<p>4. Lateral resolution</p> $\frac{0.51 \cdot \lambda_{exc}}{NA}$ <p>FWHM of PSF_{III} (intensity distribution at the focus of the microscope objective) in X/Y direction plus contrast-enhancing effect of the pinhole because of stray light suppression.</p>	<p>4. Lateral resolution</p> $\frac{0.37 \cdot \bar{\lambda}}{NA}$ <p>FWHM of total PSF in X/Y direction plus contrast-enhancing effect of the pinhole because of stray light suppression.</p>

All data in the table refer to quantities in the object space and apply to a fluorescent point object.

1) PH < ∞ is meant to express a pinhole diameter of < 4–5 AU.

Sampling and Digitization

After the optical phenomena have been discussed in Part 1, Part 2 takes a closer look at how the digitizing process and system-inherent sources of noise limit the performance of the system .

As stated in Part 1, a confocal LSM scans the specimen surface point by point. This means that an image of the total specimen is not formed simultaneously, with all points imaged in parallel (as, for example, in a CCD camera), but consecutively as a series of point images. The resolution obtainable depends on the number of points probed in a feature to be resolved.

Confocal microscopy, especially in the fluorescence mode, is affected by noise of light. In many applications, the number of light quanta (photons) contributing to image formation is extremely small. This is due to the efficiency of the system as a whole and the influencing factors involved, such as quantum yield, bleaching and saturation of fluorochromes, the transmittance of optical elements etc. (see *Details "Fluorescence"*). An additional influence factor is the energy loss connected with the reduction of the pinhole diameter.

In the following passages, the influences of scanning and noise on resolution are illustrated by practical examples and with the help of a two-point object. This is meant to be an object consisting of two self-luminous points spaced at 0.5 AU (see *Details "Optical Coordinates"*). The diffraction patterns generated of the two points are superimposed in the image space, with the maximum of one pattern coinciding with the first minimum of the other. The separate visibility of the points (resolution) depends on the existence of a dip between the two maxima (see figure 12).

As a rule, object information is detected by a photomultiplier tube (PMT). The PMT registers the spatial changes of object properties $I(x)$ as a temporal intensity fluctuation $I(t)$. Spatial and temporal coordinates are related to each other by the speed of the scanning process ($x = t \cdot v_{\text{scan}}$). The PMT converts optical information into electrical information. The continuous electric signal is periodically sampled by an analog-to-digital (A/D) converter and thus transformed into a discrete, equidistant succession of measured data (pixels) (figure 12).

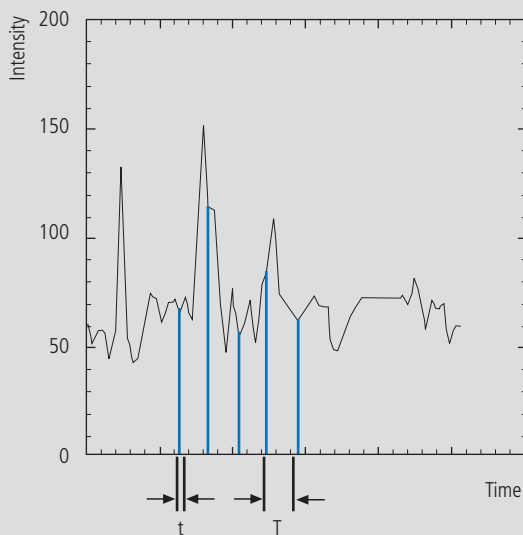
Types of A/D conversion

The quality of the image scanned depends on the type of A/D conversion which is employed. Two types can be distinguished:

- Sampling: The time (t) for signal detection (measurement) is small compared to the time (T) per cycle (pixel time) (see figure 12).
- Integration: The signal detection time has the same order of magnitude as the pixel time.

Integration is equivalent to an averaging of intensities over a certain percentage of the pixel time known as pixel dwell time. To avoid signal distortion (and thus to prevent a loss of resolution), the integration time must be shorter than the pixel time. The highest resolution is attained with point sampling (the sampling time is infinitesimally short, so that a maximum density of sampling points can be obtained). By signal integration, a greater share of the light emitted by the specimen contributes to the image signal. Where signals are weak (e.g. fluorescence), this is a decisive advantage over point sampling with regard to the signal-to-noise ratio (SNR). Therefore, Carl Zeiss confocal LSM systems operate in the integration mode, as a rule. The absolute integration time can be modified by varying the scanning speed, which also means a change of the pixel time.

Fig. 12 Pointwise sampling of a continuous signal
 T = spacing of two consecutive sampling points
 t = time of signal detection ($t \ll T$)



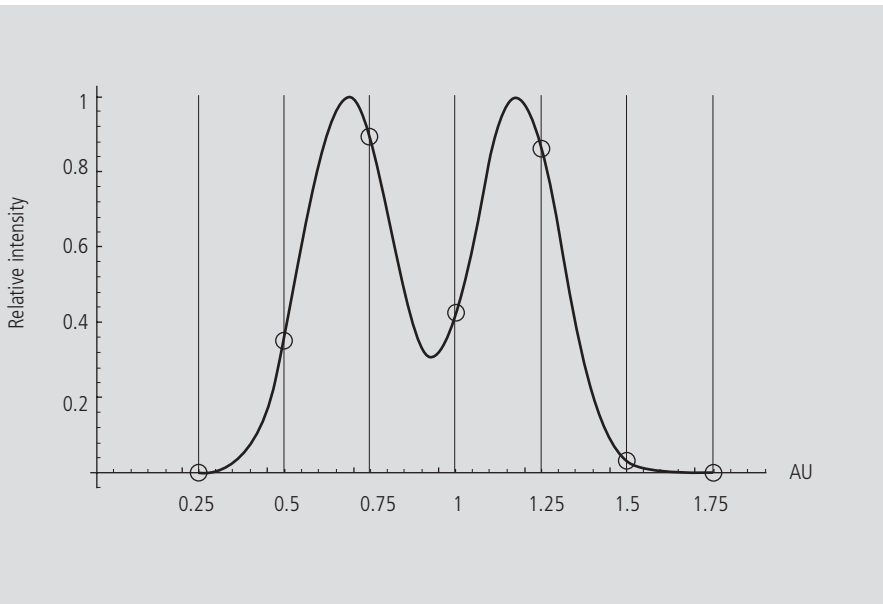
Nyquist theorem

It is known from Part 1 that the information content of the signal is limited by the resolving power of the microscope optics. A realistic estimate for the resolving power is the full width at half maximum intensity ($FWHM_{lat}$) of a point image (see equation 3).

To avoid a loss of information during the scanning process, it is necessary to stick to the Nyquist theorem. The optimal pixel spacing in scanning a periodic signal, as defined by the Nyquist theorem, is half the period of the feature spacing to be resolved, or two pixels per resolvable structure detail. Together with the resolving power defined above, this results in a maximum pixel spacing of $d_{pix} = 0.5 \times FWHM_{lat}$.

With a two-point object (see explanation on page 17), the pixel spacing needed to separate the two Airy discs in the digitized image is 0.25 AU (figure 13).

Fig. 13 The graph illustrates the scanning of a two-point object with the minimum number of sampling points needed to avoid a loss of resolution (spacing of sampling points 0.25 AU).

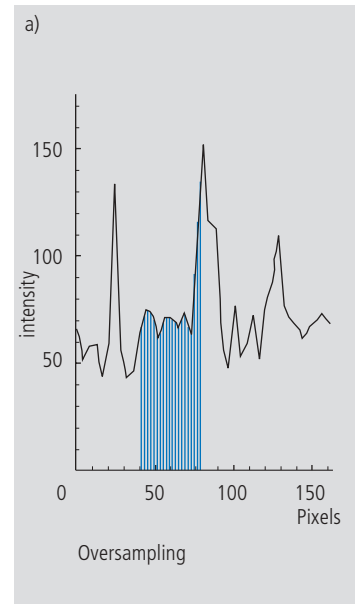


If the number of sampling points per feature size is smaller than that given by the Nyquist theorem (undersampling), part of the information will be lost. This is evident in Figure 14c especially by the unresolved fine features.

A greater number of sampling points per feature size (oversampling) means a greater number of readings without a gain in information; simultaneously, the time per pixel becomes shorter. Thus, the volume of data to be processed is inflated, and the noise of the measurement signal increases (see page 20)

Under unfavorable conditions, also artefacts may result out of the digitization process (aliasing). As a rule, this is the case if the feature spacing in the specimen is equal, or nearly equal, to the pixel spacing.

Fig. 14 Oversampling, correct sampling and undersampling of a continuous signal.



Pixel size

A quantity of decisive importance in this connection is the maximum scanning angle set via the scanning zoom. By varying the scanning angle, it is possible to directly influence the edge length of the scanned field in the intermediate image plane (or object plane), and thus the pixel size (at a given number of pixels per line). The smaller the scanning angle, the smaller is the edge length of the scanned field, and the smaller is the pixel (see the example below).

In this way, the user of a Carl Zeiss confocal LSM can control the sampling rate (pixel size). For setting the suitable scanning zoom for correct Nyquist sampling, the pixel size d_{pix} in the object plane is important.

For a Carl Zeiss confocal LSM, there is a simple formula, based on the edge length of the scanned field in the intermediate image:

$$d_{pix} = \frac{\text{system constant}}{\text{number of pixels} \cdot \text{zoomfactor} \cdot \text{magnification}_{obj}}$$

Number of pixels = number of pixels per line

Zoom factor (Z) = scanning zoom set in the software
(Example: Zoom factor 2 reduces the edge length of the scanned field by a factor of 2)

Magnification_{obj} = objective magnification

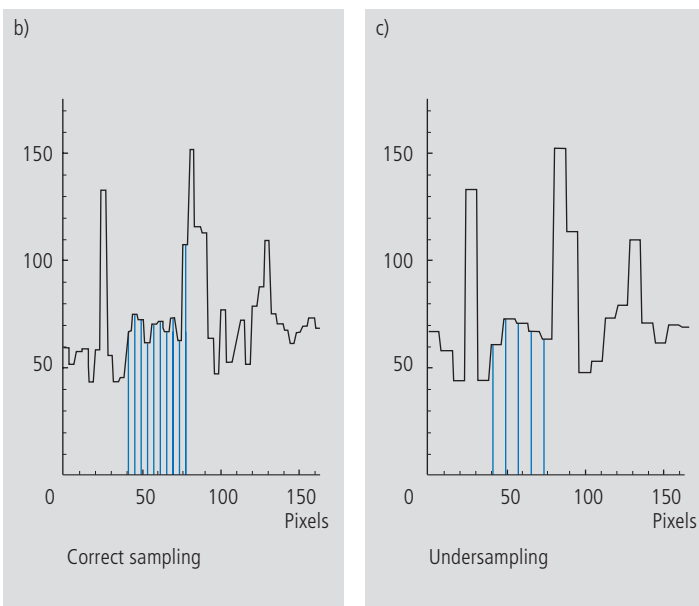
System constant = 8.94 mm with LSM 510, LSM 5 Pascal (minimum zoom factor = 0.7); 12.77 mm with LSM 310, LSM 410 (minimum zoom factor=1)

The minimum scanning zoom needed to fulfill the Nyquist theorem can therefore be calculated as follows:

$$Z \geq \frac{3.92 \cdot NA \cdot \text{system constant}}{\text{number of pixels} \cdot \text{magnification}_{obj} \cdot \lambda_{exc}}$$

NA = numerical aperture of objective

λ_{exc} = excitation wavelength



For example, with a 40x objective (NA = 1.3), 512 pixels per scan line and a wavelength of 488 nm, the full resolving power (correct sampling) is achieved with a scanning zoom of 4.56 as a minimum; the corresponding pixel size is 95.8 nm. With lower factors of the scanning zoom the pixel size itself will be the limiting factor for resolution (pixel resolution). Higher factors will cause over-sampling. Hence, the zoom factor influences not only the total magnification but also the resolution properties of the system.

With the more recent LSM systems of Carl Zeiss, the number of sampling points can also be influenced by an increase in the number of pixels per scan line.

(The number of pixels (X/Y) per image can be freely selected between 4 x 2 and 2048 x 2048).

Noise

The main types of noise important in a confocal LSM system are detector noise (dark noise, secondary emission noise), laser noise, and shot noise of the light (see *Details "Sources of Noise"*). As a rule, these sources of noise are of a statistical nature. Periodic noise rarely occurs, and if it does, it tends to correlate with defective devices or mechanical vibration in the setup; therefore it has been left out of consideration here.

As the graphs in figure 15 show, the number of photons hitting the PMT depends not only on the intensity of the fluorescence signal (see *Details "Fluorescence"*), but also on the diameter of the pinhole. The graph shows the intensity distribution of a two-point object resulting behind the pinhole, in normalized (left) and non-normalized form (right). The pinhole diameter was varied between 2 AU and 0.05 AU. At a diameter of 1 AU the pinhole just equals the size of the Airy disk, so that there is only a slight loss in intensity. The gain in resolution, is minimum in this case.

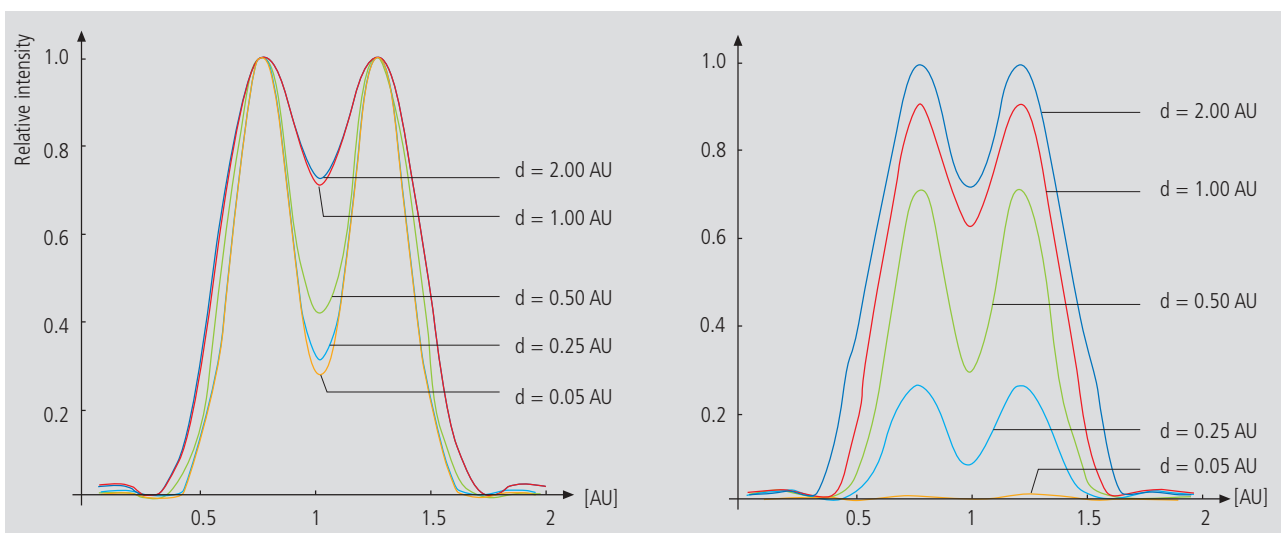
With a pinhole diameter < 1 AU, resolution improves (better point separation thanks to a deeper dip), which is penalized by a drastic loss in energy.

Moreover, it should be considered that it depends on the signal level which noise source dominates. With high-amplitude signals (number of detected photons $> 10,000$), laser noise is the dominating effect, whereas the quality of low signals (number of detected photons < 1000) is limited by the shot noise of the light.

Therefore, laser noise tends to be the decisive noise factor in observations in the reflection mode, while shot noise dominates in the fluorescence mode. With recent PMT models (e.g., from Hamamatsu), detector dark noise is extremely low, same as secondary emission noise, and both can be neglected in most practical applications (see *Details "Sources of Noise"*).

Therefore, the explanations below are focused on the influence of shot noise on lateral resolution.

Fig. 15 As shown in Part 1, small pinhole diameters lead to improved resolution (smaller FWHM, deeper dip – see normalized graph on the left). The graph on the right shows, however, that constricting the pinhole is connected with a drastic reduction in signal level. The drop in intensity is significant from $PH < 1$ AU.



Resolution and shot noise - resolution probability

If the number of photons detected (N) is below 1000, fluorescence emission should be treated as a stochastic rather than a continuous process; it is necessary, via the shot noise, to take the quantum nature of light into account (the light flux is regarded as a photon flux, with a photon having the energy $E = h \cdot \nu$). Resolution becomes contingent on random events (the random incidence of photons on the detector), and the gain in resolution obtainable by pinhole constriction is determined by the given noise level. Figure 16 will help to understand the quantum nature of light.

As a possible consequence of the shot noise of the detected light, it may happen, for example, that noise patterns that change because of photon statistics, degrade normally resolvable object details in such a way that they are not resolved every time in repeated measurements. On the other hand, objects just outside optical resolvability may appear resolved because of noise patterns modulated on them. Resolution of the "correct" object structure is the more probable the less noise is involved, i.e. the more photons contribute to the formation of the image.

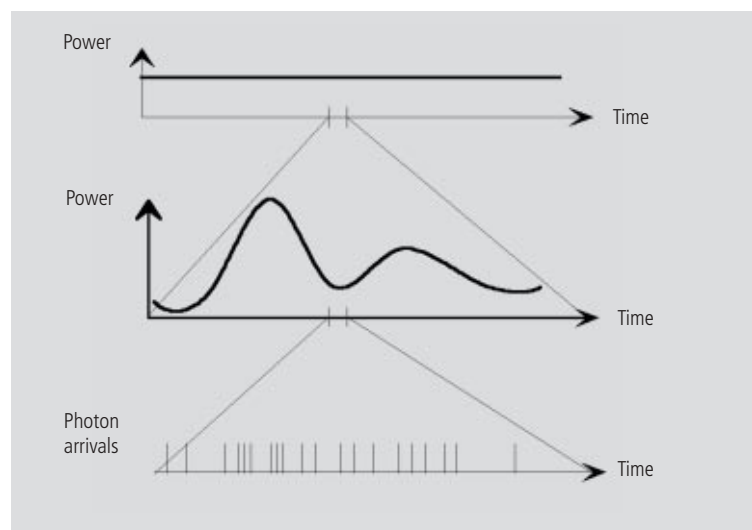
Therefore, it makes sense to talk of resolution probability rather than of resolution. Consider a model which combines the purely optical understanding of image formation in the confocal microscope (PSF) with the influences of shot noise of the detected light and the scanning and digitization of the object. The essential criterion is the discernability of object details.

Figure 17 (page 22) shows the dependence of the resolution probability on signal level and pinhole diameter by the example of a two-point object and for different numbers of photoelectrons per point object. [As the image of a point object is covered by a raster of pixels, a normalization based on pixels does not appear sensible.]

Thus, a number of 100 photoelectrons/point object means that the point object emits as many photons within the sampling time as to result in 100 photoelectrons behind the light-sensitive detector target (PMT cathode). The number of photoelectrons obtained from a point object in this case is about twice the number of photoelectrons at the maximum pixel (pixel at the center of the Airy disk). With photoelectrons as a unit, the model is independent of the sensitivity and noise of the detector and of detection techniques (absolute integration time / point sampling / signal averaging). The only quantity looked at is the number of detected photons.

Fig. 16 The quantum nature of light can be made visible in two ways:

- by reducing the intensity down to the order of single photons and
- by shortening the observation time at constant intensity, illustrated in the graph below: The individual photons of the light flux can be resolved in their irregular (statistical) succession.



A resolution probability of 90% is considered necessary for resolving the two point images. Accordingly, the two-point object defined above can only be resolved if each point produces at least about 25 photoelectrons. With pinhole diameters smaller than 0.25 AU, the drastic increase in shot noise (decreasing intensity of the detected light) will in any case lead to a manifest drop in resolution probability, down to the level of indeterminateness ($\leq 50\%$ probability) at PH = 0.

As another consequence of shot noise, the curve maximum shifts toward greater pinhole diameters as the number of photoelectrons drops.

The general slight reduction of resolution probability towards greater pinhole diameters is caused by the decreasing effectiveness of the pinhole (with regard to suppression of out-of-focus object regions, see Part 1).

The pinhole diameter selected in practice will therefore always be a trade-off between two quality parameters: noise (SNR as a function of the intensity of the detected light) and resolution (or depth discrimination). The pinhole always needs a certain minimum aperture to allow a minimum of radiation (depending on the intensity of fluorescence) to pass to the detector.

Where fluorescence intensities are low, it may be sensible to accept less than optimum depth discrimination so as to obtain a higher signal level (higher intensity of detected light = less noise, better SNR). For most fluorescent applications a pinhole diameter of about 1 AU has turned out to be the best compromise.

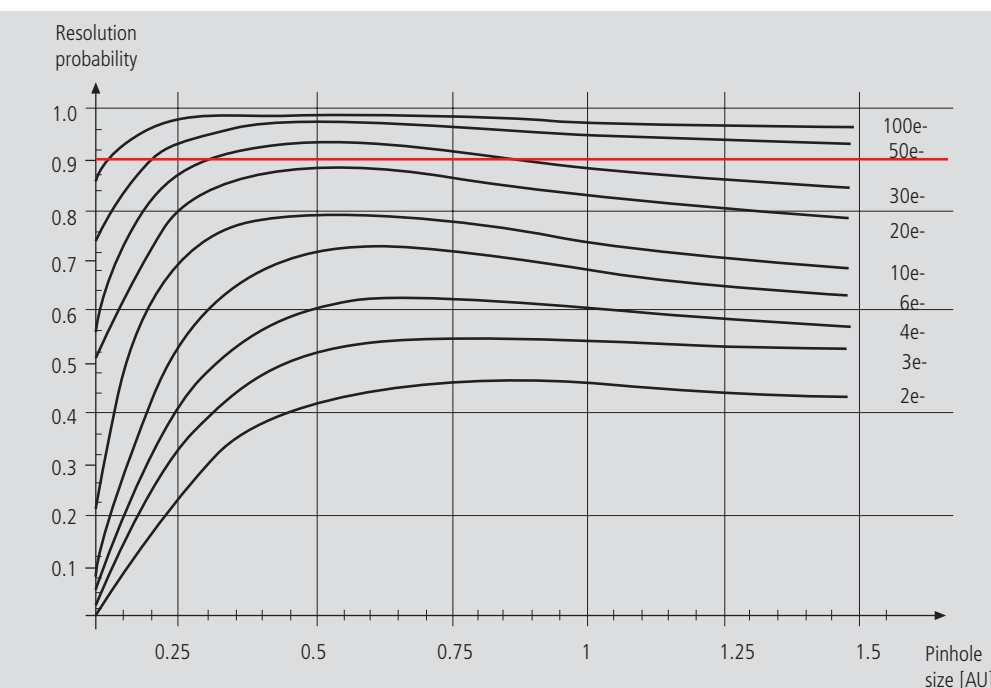


Fig. 17 The graph shows the computed resolution probability of two self-luminous points (fluorescence objects) spaced at 1/2 AU, as a function of pinhole size and for various photoelectron counts per point object (e-). The image raster conforms to the Nyquist theorem (critical raster spacing = 0.25 AU); the rasterized image is subjected to interpolation. The photoelectron count per point object is approximately twice that per pixel (referred to the pixel at the center of the Airy disk). Each curve has been fitted to a fixed number of discrete values, with each value computed from 200 experiments.

The resolution probability is the quotient between successful experiments (resolved) and the total number of experiments. A resolution probability of 70% means that 7 out of 10 experiments lead to resolved structures. A probability > 90% is imperative for lending certainty to the assumption that the features are resolved. If we assume a point-like fluorescence object containing 8 FITC fluorescence molecules (fluorochrome concentration of about 1 nMol) a laser power of 100 μ W in the pupil and an objective NA of 1.2 ($n = 1.33$), the result is about 45 photoelectrons / point object on the detection side.

Possibilities to improve SNR

Pinhole diameters providing a resolution probability below 90% may still yield useful images if one uses a longer pixel time or employs the signal averaging function. In the former case, additional photons are collected at each pixel; in the latter case, each line of the image, or the image as a whole, is scanned repeatedly, with the intensities being accumulated or averaged. The influence of shot noise on image quality decreases as the number of photons detected increases. As fluorescence images in a confocal LSM tend to be shot-noise-limited, the increase in image quality by the methods described is obvious.

Furthermore, detector noise, same as laser noise at high signal levels, is reduced. The figures on the right show the influence of pixel time (figure 18) and the influence of the number of signal acquisitions (figure 19) on SNR in [dB]. The linearity apparent in the semilogarithmic plot applies to shot-noise-limited signals only. (As a rule, signals are shot-noise-limited if the PMT high voltage needed for signal amplification is greater than 500 V).

A doubling of pixel time, same as a doubling of the number of signal acquisitions, improves SNR by a factor of $\sqrt{2}$ (3 dB). The advantage of the

averaging method is the lower load on the specimen, as the exposure time per pixel remains constant. Photon statistics are improved by the addition of photons from several scanning runs ($SNR = \sqrt{n \cdot N}$; $N = \text{const.}$, $n = \text{number of scans averaged}$). By comparison, a longer pixel time directly improves the photon statistics by a greater number N of photons detected per pixel ($SNR = \sqrt{N}$, $N = \text{variable}$), but there is a greater probability of photobleaching or saturation effects of the fluorophores.

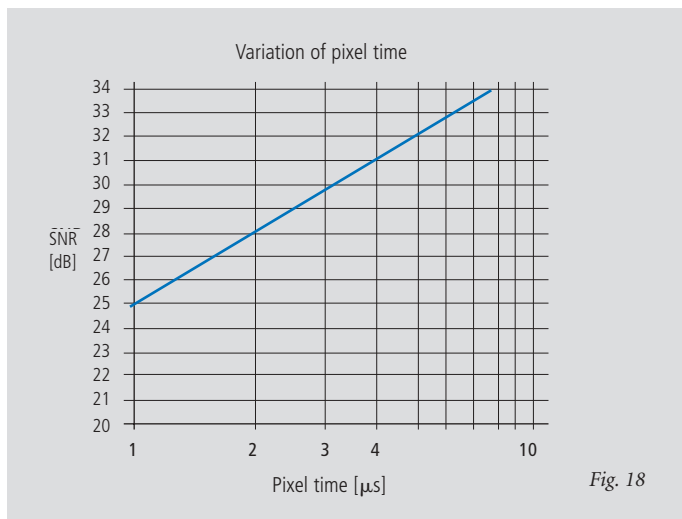


Fig. 18

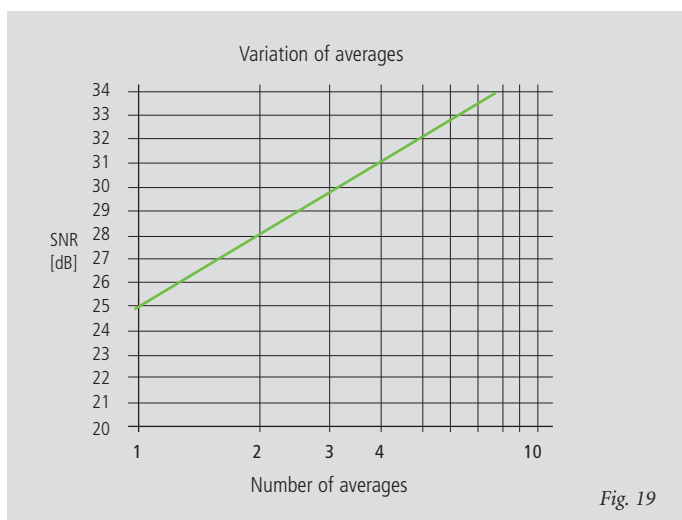
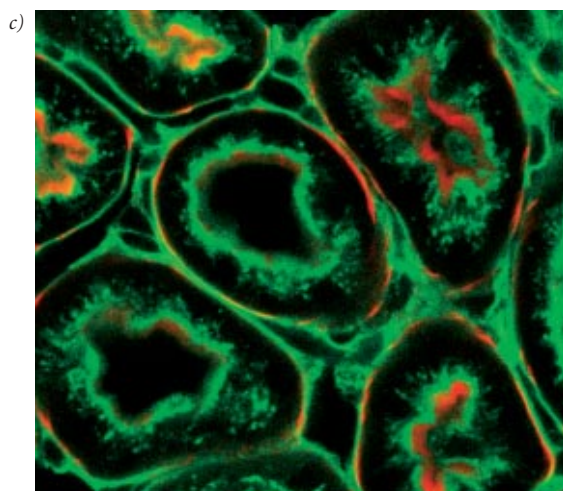
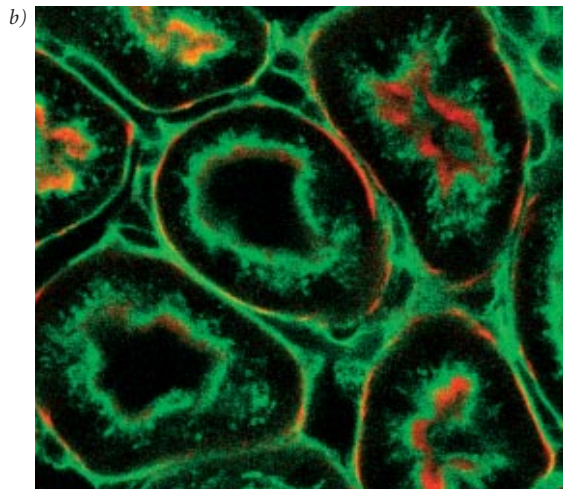
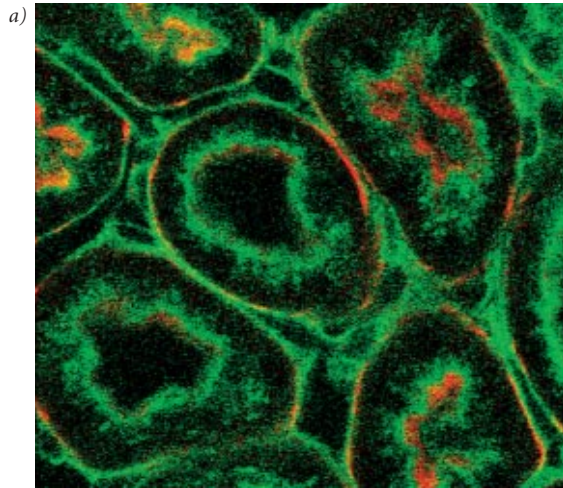


Fig. 19

Figures 18 and 19 Improvement of the signal-to-noise ratio. In figure 18 (top), pixel time is varied, while the number of signal acquisitions (scans averaged) is constant. In figure 19 (bottom), pixel time is constant, while the number of signal acquisitions is varied. The ordinate indicates SNR in [dB], the abscissa the free parameter (pixel time, scans averaged).



The pictures on the left demonstrate the influence of pixel time and averaging on SNR; object details can be made out much better if the pixel time increases or averaging is employed.

Another sizeable factor influencing the SNR of an image is the efficiency of the detection beam path. This can be directly influenced by the user through the selection of appropriate filters and dichroic beamsplitters. The SNR of a FITC fluorescence image, for example, can be improved by a factor of about 4 (6 dB) if the element separating the excitation and emission beam paths is not a neutral 80/20 beamsplitter¹ but a dichroic beamsplitter optimized for the particular fluorescence.

Fig. 20 Three confocal images of the same fluorescence specimen (mouse kidney section, glomeruli labeled with Alexa488 in green and actin labelled with Alexa 564 phalloidin in red).

All images were recorded with the same parameters, except pixel time and average. The respective pixel times were 0.8 μ s in a), 6.4 μ s (no averaging) in b), and 6.4 μ s plus 4 times line-wise averaging in c).

¹An 80/20 beamsplitter reflects 20% of the laser light onto the specimen and transmits 80% of the emitted fluorescence to the detector.

Summary

This monograph comprehensively deals with the quality parameters of resolution, depth discrimination, noise and digitization, as well as their mutual interaction. The set of equations presented allows in-depth theoretical investigations into the feasibility of carrying out intended experiments with a confocal LSM.

The difficult problem of quantifying the interaction between resolution and noise in a confocal LSM is solved by way of the concept of resolution probability; i.e. the unrestricted validity of the findings described in Part 1 is always dependent on a sufficient number of photons reaching the detector.

Therefore, most applications of confocal fluorescence microscopy tend to demand pinhole diameters greater than 0.25 AU; a diameter of 1 AU is a typical setting.

Glossary

α	Aperture angle of a microscope objective
AU	Airy unit (diameter of Airy disc)
dpix	Pixel size in the object plane
FWHM	Full width at half maximum of an intensity distribution (e.g. optical slice)
n	Refractive index of an immersion liquid
NA	Numerical aperture of a microscope objective
PH	Pinhole; diaphragm of variable size arranged in the beam path to achieve optical sections
PMT	Photomultiplier tube (detector used in LSM)
PSF	Point spread function
RU	Rayleigh unit
SNR	Signal-to-noise ratio

To give some further insight into Laser Scanning Microscopy, the following pages treat several aspects of particular importance for practical work with a Laser Scanning Microscope.

Pupil Illumination

Optical Coordinates

Fluorescence

Sources of Noise

Pupil Illumination

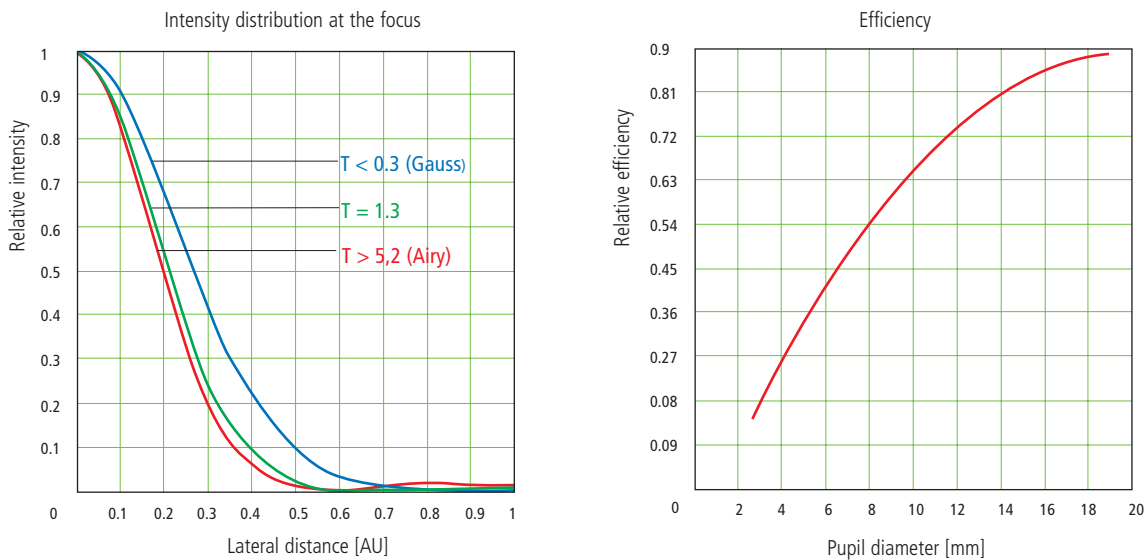
All descriptions in this monograph suggest a confocal LSM with a ray geometry providing homogeneous illumination at all lens cross sections. The focus generated in the object has an Airy distribution, being a Fourier transform of the intensity distribution in the objective's pupil plane. However, the truncation of the illuminating beam cross-section needed for an Airy distribution causes a certain energy loss (a decrease in efficiency). [In Carl Zeiss microscope objectives, the pupil diameter is implemented by a physical aperture close to the mounting surface].

The Airy distribution is characterized by a smaller width at half maximum and a higher resolving power. Figure 21 (left) shows the intensity distribution at the focus as a function of the truncation factor T (the ratio of laser beam diameter ($1/e^2$) and pupil diameter).

The graph presents the relative intensity distributions at the focus (each normalized to 1) for different truncation factors. (The red curve results at a homogeneous pupil illumination with $T > 5.2$, while the blue one is obtained at a Gaussian pupil illumination with $T \leq 0.5$; the green curve

corresponds to a truncation factor $T = 1.3$). The lateral coordinate is normalized in Airy units (AU). From $T = 3$, the Airy character is predominating to a degree that a further increase in the truncation factor no longer produces a gain in resolution. (Because of the symmetry of the point image in case of diffraction-limited imaging, the graph only shows the intensity curve in the +X direction). Figure 21 (right) shows the percentage efficiency as a function of pupil diameter in millimeter, with constant laser beam expansion. The smaller the pupil diameter, the higher the T-factor, and the higher the energy loss (i.e. the smaller the efficiency). Example: If the objective utilizes 50% of the illuminating energy supplied, this means about 8% resolution loss compared to the ideal Airy distribution. Reducing the resolution loss to 5% is penalized by a loss of 70% of the illuminating energy. In practice, the aim is to reach an optimal approximation to a homogeneous pupil illumination; this is one reason for the fact that the efficiency of the excitation beam path in a confocal LSM is less than 10%.

Fig. 21



The truncation factor T is defined as the ratio of laser beam and pupil diameter of the objective lens used: $T = \frac{d_{laser}}{d_{pupille}}$; the resulting efficiency is defined as $\eta = 1 - e^{\left(\frac{-2}{T^2}\right)}$

The full width at half maximum of the intensity distribution at the focal plane is defined as $FWHM = 0.71 \cdot \frac{\lambda}{NA} \cdot \omega$, with $\omega = \sqrt{0.51 + 0.14 \cdot \ln\left(\frac{1}{1-n}\right)}$

With $T < 0.6$, the Gaussian character, and with $T > 1$ the Airy character predominates the resulting intensity distribution.

Optical Coordinates

In order to enable a representation of lateral and axial quantities independent of the objective used, let us introduce optical coordinates oriented to microscopic imaging.

Given the imaging conditions in a confocal microscope, it suggests itself to express all lateral sizes as multiples of the Airy disk diameter. Accordingly, the Airy unit (AU) is defined as:

$$1AU = \frac{1.22 \cdot \bar{\lambda}}{NA}$$

NA = numerical aperture of the objective
 $\bar{\lambda}$ = wavelength of the illuminating laser light
with $NA = 1.3$ and $\bar{\lambda} = 496 \text{ nm}$ $\rightarrow 1AU = 0.465 \mu\text{m}$

The AU is primarily used for normalizing the pinhole diameter.

Thus, when converting a given pinhole diameter into AUs, we need to consider the system's total magnification; which means that the Airy disk is projected onto the plane of the pinhole (or vice versa).

Analogously, a sensible way of normalization in the axial direction is in terms of multiples of the wave-optical depth of field. Proceeding from the Rayleigh criterion, the following expression is known as Rayleigh unit (RU):

$$1RU = \frac{1.22 \cdot \bar{\lambda}}{NA^2}$$

n = refractive index of immersion liquid
with $NA = 1.3$, $\bar{\lambda} = 496 \text{ nm}$ and $n = 1.52$ $\rightarrow 1RU = 0.446 \mu\text{m}$

The RU is used primarily for a generally valid representation of the optical slice thickness in a confocal LSM.

Fluorescence

Fluorescence is one of the most important contrasting methods in biological confocal microscopy.

Cellular structures can be specifically labeled with dyes (fluorescent dyes = fluorochromes or fluorophores) in various ways. Let the mechanisms involved in confocal fluorescence microscopy be explained by taking fluorescein as an example of a fluorochrome. Fluorescein has its absorption maximum at 490 nm. It is common to equip a confocal LSM with an argon laser with an output of 15–20 mW at the 488 nm line. Let the system be adjusted to provide a laser power of 500 μ W in the pupil of the microscope objective. Let us assume that the microscope objective has the ideal transmittance of 100 %.

With a C-Apochromat 63x/1.2W, the power density at the focus, referred to the diameter of the Airy disk, then is $2.58 \cdot 10^5$ W/cm². This corresponds to an excitation photon flux of $6.34 \cdot 10^{23}$ photons/cm² sec. In conventional fluorescence microscopy, with the same objective, comparable lighting power (xenon lamp with 2 mW at 488 nm) and a visual field diameter of 20 mm, the excitation photon flux is only $2.48 \cdot 10^{18}$ photons/cm² sec, i.e. lower by about five powers of ten.

This is understandable by the fact that the laser beam in a confocal LSM is focused into the specimen, whereas the specimen in a conventional microscope is illuminated by parallel light.

The point of main interest, however, is the fluorescence (F) emitted.

The emission from a single molecule (F) depends on the molecular cross-section (σ), the fluorescence quantum yield (Qe) and the excitation photon flux (I) as follows:

$$F = \sigma \cdot Qe \cdot I \text{ [photons/sec]}$$

In principle, the number of photons emitted increases with the intensity of excitation. However, the limiting parameter is the maximum emission rate of the fluorochrome molecule, i.e. the number of photons emittable per unit of time. The maximum emission rate is determined by the lifetime (= radiation time) of the excited state. For fluorescein this is about 4.4 nsec (subject to variation according to the ambient conditions). On average, the maximum emission rate of fluorescein is $2.27 \cdot 10^8$ photons/sec. This corresponds to an excitation photon flux of $1.26 \cdot 10^{24}$ photons/cm² sec.

At rates greater than $1.26 \cdot 10^{24}$ photons/cm² sec, the fluorescein molecule becomes saturated. An increase in the excitation photon flux will then no longer cause an increase in the emission rate; the number of photons absorbed remains constant. In our example, this case occurs if the laser power in the pupil is increased from 500 μ W to roughly 1 mW. Figure 22 (top) shows the relationship between the excitation photon flux and the laser power in the pupil of the stated objective for a wavelength of 488 nm. Figure 22 (bottom) illustrates the excited-state saturation of fluorescein molecules. The number of photons absorbed is approximately proportional to the number of photons emitted (logarithmic scaling).

The table below lists the characteristics of some important fluorochromes:

	Absorpt. max.(nm)	$\sigma/10^{-16}$	Qe	$\sigma^*Q/10^{-16}$
Rhodamine	554	3.25	0.78	0.91
Fluorescein	490	2.55	0.71	1.81
Texas Red	596	3.3	0.51	1.68
Cy 3.18	550	4.97	0.14	0.69
Cy 5.18	650	7.66	0.18	1.37

Source:

Handbook of Biological Confocal Microscopy, p. 268/Waggoner

In the example chosen,

F = $1.15 \cdot 10^8$ photons/sec or 115 photons/ μ sec

What has been said so far is valid only as long as the molecule is not affected by photobleaching. In an oxygen-rich environment, fluorescein bleaches with a quantum efficiency of about $2.7 \cdot 10^{-5}$. Therefore, a fluorescence molecule can, on average, be excited $n = 26,000$ times ($n = Q/Q_b$) before it disintegrates.

With $t = \frac{n}{F_{\max}}$, and referred to the maximum emission rate, this corresponds to a lifetime of the fluorescein molecule of about $115 \mu\text{s}$.

It becomes obvious that an increase in excitation power can bring about only a very limited gain in the emission rate. While the power provided by the laser is useful for FRAP (fluorescence recovery after photobleaching) experiments, it is definitely too high for normal fluorescence applications. Therefore it is highly important that the excitation power can be controlled to fine increments in the low-intensity range.

A rise in the emission rate through an increased fluorophore concentration is not sensible either, except within certain limits. As soon as a certain molecule packing density is exceeded, other effects (e.g. quenching) drastically reduce the quantum yield despite higher dye concentration. Another problem to be considered is the system's detection sensitivity. As the fluorescence radiated by the molecule goes to every spatial direction with the same probability, about 80% of the photons will not be captured by the objective aperture ($NA = 1.2$).

With the reflectance and transmittance properties of the subsequent optical elements and the quantum efficiency of the PMT taken into account, less than 10% of the photons emitted are detected and converted into photoelectrons (photoelectron = detected photon).

In case of fluorescein ($NA = 1.2$, $100 \mu\text{W}$ excitation power, $\lambda = 488 \text{ nm}$), a photon flux of $F \sim 23 \text{ photons}/\mu\text{sec}$ results. In combination with a sampling time of $4 \mu\text{sec}/\text{pixel}$ this means 3–4 photoelectrons/molecule and pixel.

In practice, however, the object observed will be a labeled cell. As a rule, the cell volume is distinctly greater than the volume of the sampling point. What is really interesting,

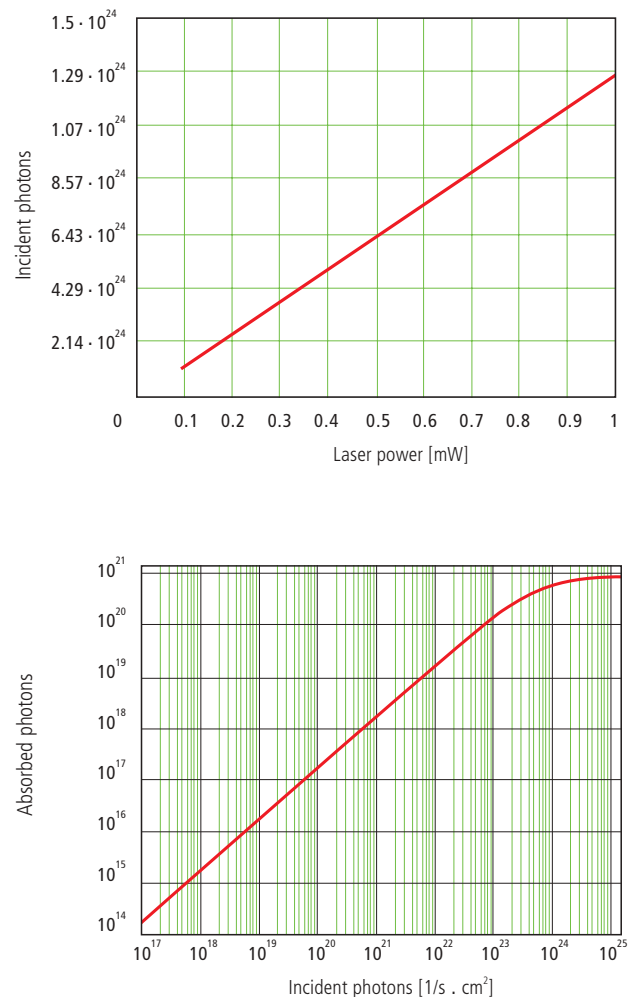


Fig. 22 Excitation photon flux at different laser powers (top) and excited-state saturation behavior (absorbed photons) of fluorescein molecules (bottom).

therefore, is the number of dye molecules contained in the sampling volume at a particular dye concentration. In the following considerations, diffusion processes of fluorophore molecules are neglected. The computed numbers of photoelectrons are based on the parameters listed above.

With $\lambda = 488 \text{ nm}$ and $NA = 1.2$ the sampling volume can be calculated to be $V = 12.7 \cdot 10^{-18} \text{ l}$. Assuming a dye concentration of $0.01 \mu\text{Mol/l}$, the sampling volume contains about 80 dye molecules. This corresponds to a number of about 260 photoelectrons/pixel. With the concentration reduced to 1 nMol/l , the number of dye molecules drops to 8 and the number of photoelectrons to 26/pixel.

Finally it can be said that the number of photons to be expected in many applications of confocal fluorescence microscopy is rather small (< 1000). If measures are taken to increase the number of photons, dye-specific properties such as photobleaching have to be taken into account.

Sources of Noise

Sources of noise effective in the LSM exist everywhere in the signal chain – from the laser unit right up to A/D conversion. Essentially, four sources of noise can be distinguished:

Laser noise q

Laser noise is caused by random fluctuations in the filling of excited states in the laser medium. Laser noise is proportional to the signal amplitude N and therefore significant where a great number of photons ($N < 10000$) are detected.

Shot noise (Poisson noise)

This is caused by the quantum nature of light. Photons with the energy $h \cdot \nu$ hit the sensor at randomly distributed time intervals. The effective random distribution is known as Poisson distribution. Hence,

$$SNR \approx \Delta N_{Poisson} = \sqrt{N}$$

where N = number of photons detected per pixel time (= photoelectrons = electrons released from the PMT cathode by incident photons). With low photoelectron numbers ($N < 1000$), the number N of photons incident on the sensor can only be determined with a certainty of $\pm \sqrt{N}$.

N can be computed as

$$N = \frac{\text{photons}}{QE_{(\lambda)} \cdot \text{pixel time}}$$

where $QE(\lambda)$ = quantum yield of the sensor at wavelength λ ; 1 photon = $h \cdot c / \lambda$; c = light velocity; h = Planck's constant

Secondary emission noise

Caused by the random variation of photoelectron multiplication at the dynodes of a PMT. The amplitude of secondary emission noise is a factor between 1.1 and 1.25, depending on the dynode system and the high voltage applied (gain). Generally, the higher the PMT voltage, the lower the secondary emission noise; a higher voltage across the dynodes improves the collecting efficiency and reduces the statistical behavior of multiplication.

Dark noise

Dark noise is due to the generation of thermal dark electrons N_d , irrespective of whether the sensor is irradiated. N_d statistically fluctuates about $\sqrt{N_d}$. Dark noise is specified for a PMT voltage of 1000 V; with lower voltages it progressively loses significance.

Dark noise can be reduced by cooling the sensor. However, the reduction is significant only if $N \leq N_d$, e.g. in object-free areas of a fluorescence specimen. In addition, the dark noise must be the dominating noise source in order that cooling effects a signal improvement; in most applications, this will not be the case.

Additional sources of noise to be considered are amplifier noise in sensor diodes and readout noise in CCD sensors. In the present context, these are left out of consideration.

The mean square deviation ΔN from the average ($N + N_d$) of the photoelectrons and dark electrons registered,

$$\Delta N = se \cdot \sqrt{(N + N_d) (1 + q^2)}$$

so that the total signal-to-noise ratio can be given as

$$SNR = \sqrt{\frac{N^2}{se^2 (N + N_d) (1 + q^2)}}$$

where

N = number of photoelectrons per pixel time (sampling time)

se = multiplication noise factor of secondary emission

q = peak-to-peak noise factor of the laser

N_d = number of dark electrons in the pixel or sampling time

Example:

For $N = 1000$, $N_d = 100$, $se = 1.2$, and $q = 0.05$

$$SNR = \sqrt{\frac{1000^2}{1.2^2 (1000 + 100) (1 + 0.05^2)}} = 25.1$$

LITERATURE

1. Barton, D.L., Tangyunyong, P.,

Scanning Fluorescent Microthermal Imaging, Proceedings of 23rd Int Symposium for Testing and Failure Analysis (10/1997), Santa Clara, California

2. Barton, D.L., Tangyunyong, P.,

Infrared Light Emission from Semiconductor Devices, ISTFA, pp. 9-17, (1996)

3. Beyer, H.,

Handbuch der Mikroskopie, 2nd Edition, VEB Verlag Technik Berlin, (1985)

4. Born & Wolf,

Principles of Optics, 6th edition 1988, Pergamon Press

5. Brismar, H., Trepte, O., Ulfhake, B.:

Spectra and Fluorescence Lifetimes of Lissamine, Rhodamine etc....: Influences of Some Environmental Factors Recorded with a Confocal Laser Scanning Microscope, The Journal of Histochemistry and Cytochemistry, Vol. 43, pp. 699-707, (7/1995)

6. Keller, H.E.,

Objective Lens for Confocal Microscopy, Handbook of Biological Confocal Microscopy, pp. 111-125, Plenum Press, 2nd Edition (1995)

7. Lackmann, F., et. al.,

An Automated Latch-up Measurement System Using a Laser Scanning Microscope, SPIE Vol 1028 Scanning Imaging, (1988)

8. Gröbler, B.,

Untersuchungen zur Bildübertragung in abtastenden Mikroskopen unter besonderer Berücksichtigung der 3D-Abbildung, PhD thesis, University of Potsdam, (1995)

9. Hell, S., et al.,

Aberrations in confocal fluorescence microscopy induced by mismatches in refractive index, Journal of Microscopy, Vol. 169, pp. 391-405 (3/1993)

10. Nitschke, R., Wilhelm, S., et al.,

A modified confocal laser scanning microscope allows fast ultraviolet ratio imaging of intracellular Ca²⁺ activity using Fura 2, Euro. J. Physiologie, Vol. 433: pp. 653-663, (1997)

11. Oldenbourg, R. et al.,

Image sharpness and contrast transfer in coherent confocal microscopy, Journal of Microscopy Vol. 172, pp. 31-39, (10/1993)

12. Pawley, J.,

Handbook of Biological Confocal Microscopy, Plenum Press, 2nd Edition (1995)

13. Stelzer, E.H.K.,

The intermediate optical system of laser scanning confocal microscopes; Handbook of Biological Confocal Microscopy, pp. 139-154, Plenum Press, 2nd Edition (1995)

14. Stelzer, E.H.K., et. al.,

Nondestructive sectioning of fixed and living specimens using a confocal scanning laser fluorescence microscope: Microtomoscopy; SPIE, Vol. 809, pp. 130-136, (1987)

15. Tanke, H.J., van Oostveldt, P., et al.,

A parameter for the distribution of fluorophores in cells derived from measurements of inner filter effect and reabsorption phenomenon, Cytometry Vol. 2, pp. 359-369 (6/1982)

16. Tsien, R.Y., Waggoner, A.,

Fluorophores for Confocal Microscopy, Handbook of Biological Confocal Microscopy, pp. 267-277, Plenum Press, 2nd Edition (1995)

17. Webb, R.H., Dorey, C.K.,

The Pixelated Image, Handbook of Biological Confocal Microscopy, pp. 55-66, Plenum Press, 2nd Edition (1995)

18. Wilhelm, S.,

Über die 3-D Abbildungsqualität eines konfokalen Laser Scan Mikroskops, Dissertation, Fachhochschule Köln, (1994)

19. Wilson, T., Carlini, A.R.,

Three dimensional imaging in confocal imaging systems with finite sized detectors; Journal of Microscopy, Vol. 149, pp. 51-66, (1/1988)

20. Wilson, T., Carlini, A.R.,

Size of detector in confocal imaging systems; Optical Letters Vol. 12, pp. 227-229, (4/1987)

21. Wilson, T., Sheppard, C.J.R.,

Theory and Practice of Scanning Optical Microscopy, Academic Press, 2nd Edition (1985)

Carl Zeiss
Advanced Imaging Microscopy
07740 Jena
GERMANY
Phone: ++49-36 41 64 34 00
Telefax: ++49-36 41 64 31 44
E-Mail: micro@zeiss.de
www.zeiss.de/lsm

Subject to change.

AUTHORS

**Stefan Wilhelm, Bernhard Gröbler,
Martin Gluch, Hartmut Heinz †**



(Carl Zeiss Jena GmbH)

We gratefully acknowledge the assistance of many other staff members who contributed to this brochure.

Laser

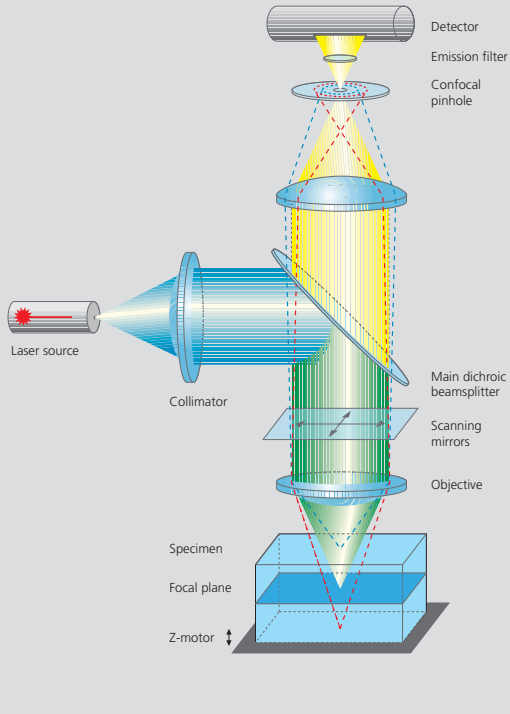
- **Light source** – projected into specimen
- **Laser power:** adjustable via attenuation device (AOTF, AOM, MOTF) and tube current setting (Ar)
- **Lifetime Δr:** prolonged by using lower tube current; but laser noise will be increased (8 A = minimum noise)
- **Stand-by mode:** prolongs laser lifetime; not suitable for image acquisition
- **Laser line:** can be chosen via selection device (AOTF, MOTF) dependent on fluorescent dye. Generally: the shorter the wavelength, the higher the resolution
- **Application goals:** (1) Protect specimen (reduction of dye bleaching and phototoxicity) by reduction of laser power. (2) Maximize fluorescence signal (higher SNR) by longer pixel dwell times or averaging

Scanning Mirrors

- **Scanning unit** – moves focused laser beam across specimen line by line
- **Scanning speed:** defines frame rate (frames/sec) and pixel time, i.e. time the specimen is illuminated
- **Pixel time:** influences SNR of image; the longer the pixel time, the more photons per pixel, the less noise in the picture; but bleaching of fluorochromes may increase
- **Pixel resolution:** maximum resolution can be achieved if pixel size is set correctly (at least 4 x 4 pixels (x, y) per smallest detail) → directly adjustable via scan zoom
- **x/y frame size:** variable from 4 x 2 up to 2048 x 2048 pixels; maximum frame rate with 512 x 512 pixels 5 frames/sec (bidirectional scan ); unidirectional scan : slower by factor 2

Z-Motor

- **Focusing the specimen** – acquisition of image stacks or x-z sections
- **z-interval:** distance between two optical slices (step size of z-motor: min. 25 nm)
- **Optimum z-motor step size:** 0.5 x optical slice thickness (compare: min. slice thickness about 340 nm for NA=1.4, n=1.52, λ=488 nm)
- **Optional:** fast z-scanning stage (HRZ) fast piezo objective focus



Photomultiplier (PMT)

- **Detector** – pixelwise detection of photons emitted/ reflected by the respective specimen detail
- **Parameters:** "Detector Gain" = PMT high voltage, "Amplifier Offset" = black level setting, "Amplifier Gain" = electronic post-amplification
- **Calibration:** "Amplifier Offset" on image background (object-free area), "Detector Gain" according to scanned image (object); setting aid = "Range Indicator" (→ "Palette"). Goal: least number of overmodulated (red, Gain) and undermodulated (blue, Offset) pixels
- **Signal amplifier:** First exploit "Detector Gain" slider before "Amplifier Gain" > 1

Confocal Pinhole

- **Depth discrimination** – confocal aperture to prevent detection of out-of-focus light (optical sectioning)
- **Diameter:** determines thickness of optical slice; optimum diameter: 1 Airy unit = best trade-off between depth discrimination capability and efficiency
- **x/y position:** factory-adjusted for all beam path configurations; can be modified manually (→ "Maintain-Pinhole" →)

Beam Splitter

- **Fluorescence beam path** – definable by combination of main (HFT) and secondary (NFT) dichroic mirrors and emission filters (BP = bandpass, LP = longpass, KP = shortpass) (→ "Acquire" → "Config")
- **HET:** separates excitation and emission light
- **NET:** effects spectral division of (different) fluorescence emissions (e.g. NFT 545: reflects light of λ < 545nm and transmits light of λ > 545nm)
- **BP, LP, KP:** determines bandwidth of fluorescence emission for the respective channel (e.g. LP 505: λ ≥ 505 nm → detection)

Objective Lens

- **Optical image formation** – determines properties of image quality such as resolution (x, y, z)
- **Numerical Aperture (NA):** determines image spot size (jointly with wavelength), and substantially influences the minimum optical slice thickness achievable
- **Refractive index (n):** match n_{immersion liquid} with n_{specimen mounting medium} for better image quality.
- **Best confocal multifluorescence images (VIS, UV):** use water immersion objectives with apochromatic correction (C- Apochromat)

3 Steps to Get a Confocal Image

1 View specimen in VIS mode

Focus the specimen in epi-fluorescence mode using the binocular and center the part of interest, select fluorescence filter cube according to application (e.g. FITC or Cy3) via SW (window "Microscope Control"); match the field of view: change to appropriate objective magnification (consider use of correct immersion medium).



2 Load an LSM configuration

Activate LSM mode (operate manual tube slider or button "LSM"). Open window "Configuration control", and select a predefined configuration from list (Single Track). A click on "Apply" automatically sets up the system: laser lines, attenuation, emission filters, beam splitters (HFT, NFT), pinhole diameter, detector settings (channels, gain, offset). Or: Click on "Reuse" button (stored image/image database window) to restore settings of a previous experiment.



3 Scan an image

Click on "Find" button (right row in window "Scan Control") => System automatically opens image window, optimizes detector settings (matches PMT gain and offset to dynamic range of 8 or 12 bit), and scans an image. See operating manual for scanning a stack of slices, time series etc.



How to Enhance Image Quality

More signal!

- Change to longer pixel dwell times by reducing scanning speed
- Use "Average" method: Calculation of "Sum" or "Mean" value of pixels of consecutive "Line" or "Frame" scans.
- Increase bandwidth of emission filter (e.g. LP instead of BP).
- Enlarge pinhole diameter; Note: optical slice thickness increases accordingly.
- Increase excitation energy (laser power); but pay attention to bleaching, saturation and phototoxic effects.

More details!

- Use objective with higher numerical aperture (NA); x/y-resolution ~ 1/NA, z-resolution ~ 1/NA².
- Increase "FrameSize" = number of pixels per line + lines per frame, e.g. 1024 x 1024 or 2048 x 2048 (min. 4 x 2).
- Optimize scan zoom (Z), i.e. pixel size ≤ 0.25 x diameter of Airy disk (e.g.: Objective 40x, NA 1.3, l = 488 nm => Z = 4.56).
- Increase dynamic range (change from 8 to 12 bit per pixel).

More reliability!

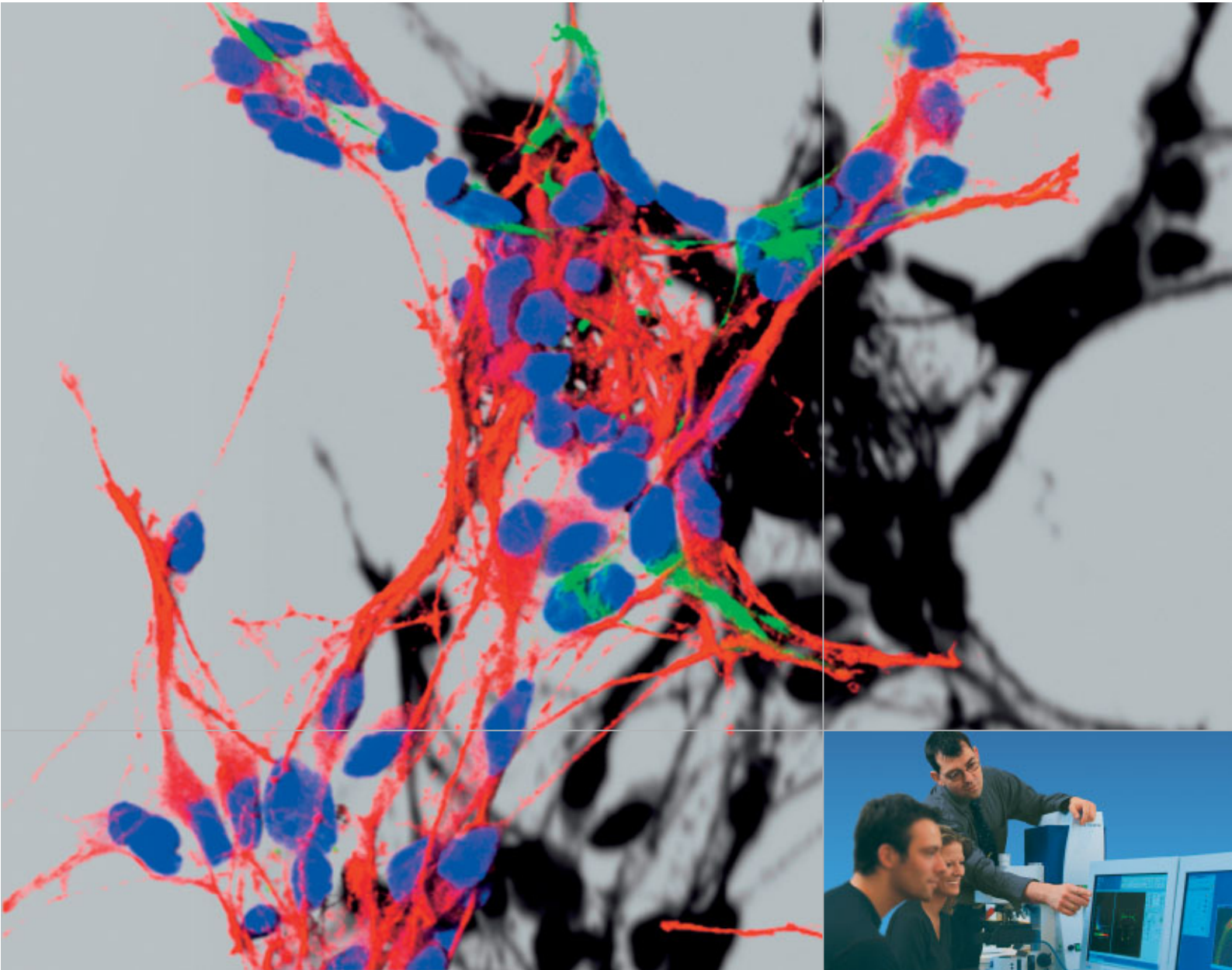
- Use Multitracking: very fast switching of excitation wavelengths; prevents crosstalk of signals between channels; predefined configurations available.
- Use ROI (Region Of Interest) function: significantly reduces excited area of specimen and increases acquisition rate at constant SNR; several ROIs of any shape can be defined and used simultaneously.

The Confocal Laser Scanning Microscope



We make it visible.

Confocal Laser Scanning Microscopy



**Applications in Research and Teaching.
Design, Functions, Methods.**



We make it visible.

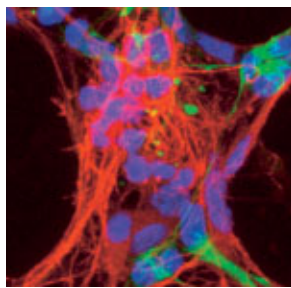
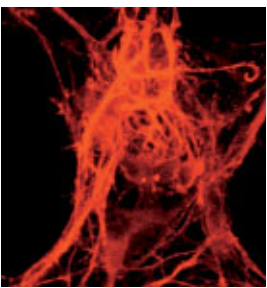
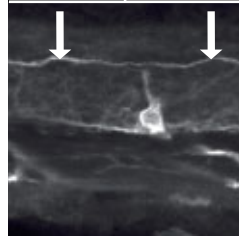
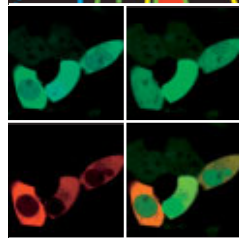
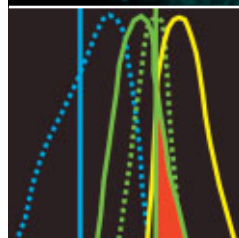
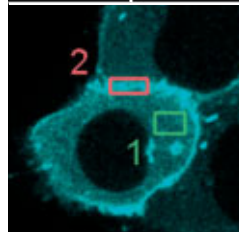
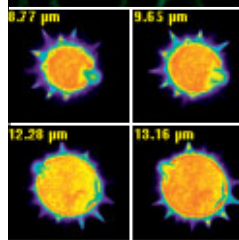
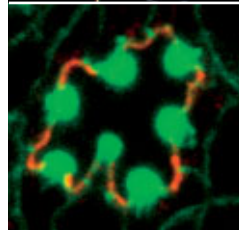
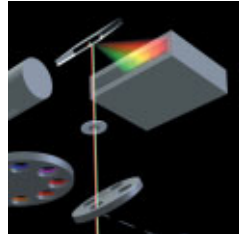
Confocal Laser Scanning Microscopy

Having decoded the human genome, biomedical research today is focused on exploring the interaction between cellular components. Scientists want to find out which protein is where, and at what time, and what other structural and functional modules it interacts with.

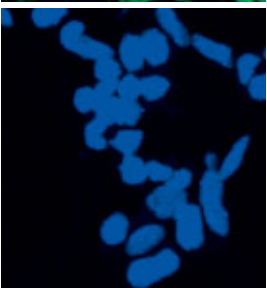
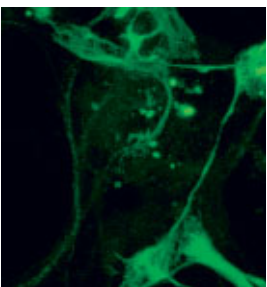
In the search for answers to these questions, imaging systems based on the classical light microscope have come to play an unprecedented role, thanks to many technical innovations and a high degree of automation. Many experiments have only become possible because of the new functions provided by modern microscopes.

Contents

High Resolution in Space and Time	3
The Confocal Principle	4
Two-Dimensional Images	6
Three-Dimensional Images	8
Time Series	10
Multifluorescence – The Crosstalk Problem and Its Solution	12
Spectral Imaging	14
Courses	22
Summary	23
Literature / Links	24



Triple staining of a primary culture of a rat's cortical neurons.
Nucleus: blue (DAPI),
Nestin: green (Cy2),
Doublecortin: red (Cy3).
Specimen: Dr. H. Braun, FAN GmbH,
Magdeburg, Germany.



High Resolution in Space and Time

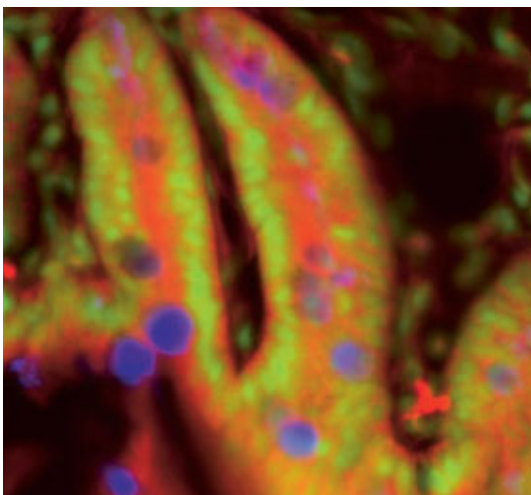
Confocal laser scanning microscopes (LSMs) are distinguished by their high spatial and temporal resolving power. They clearly outperform classical light microscopes especially by their axial resolution – a quality that enables users to acquire optical sections (slices) of a specimen. An object can thus be imaged completely in three dimensions and subsequently visualized as a 3D computer image. In another group of applications, exactly defined areas of a specimen can be selectively illuminated by laser light. This functionality is essential for quantitative investigations of dynamic processes in living cells using techniques such as FRAP (fluorescence recovery after photobleaching), FRET (fluorescence resonance energy transfer), photoactivation and photoconversion. New acquisition methods on the LSM permit the detection of additional properties of the emitted light including spectral signatures and fluores-

cence lifetimes. With such information it is possible to increase the number of fluorescent labels used in an experiment, or to use fluorochrome combinations unthinkable with conventional detection methods. The advantages are obvious: the more components in a cellular process that are observed simultaneously, the greater the yield of information.

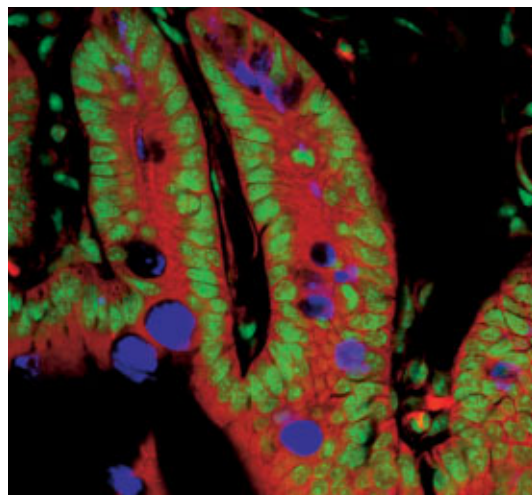
Because of its versatility, laser scanning microscopy has become an established mainstream method in biomedical research – a tool permitting scientists to follow innovative experimental paths. This article will show which basic functions and applications of laser scanning microscopy can be taught in academic tuition. The modern method of confocal laser scanning microscopy can be taught on the basis of classical light microscopy, an established part of fundamental biomedical teaching.

Triple-labeled tissue section of mouse intestine

In the non-confocal image, the interesting information of the focal plane mixes with unwanted information from extrafocal specimen planes; differently stained details result in a color mix.



In the confocal image, object details are blurred in the non-confocal image are visible clearly and in greater contrast.

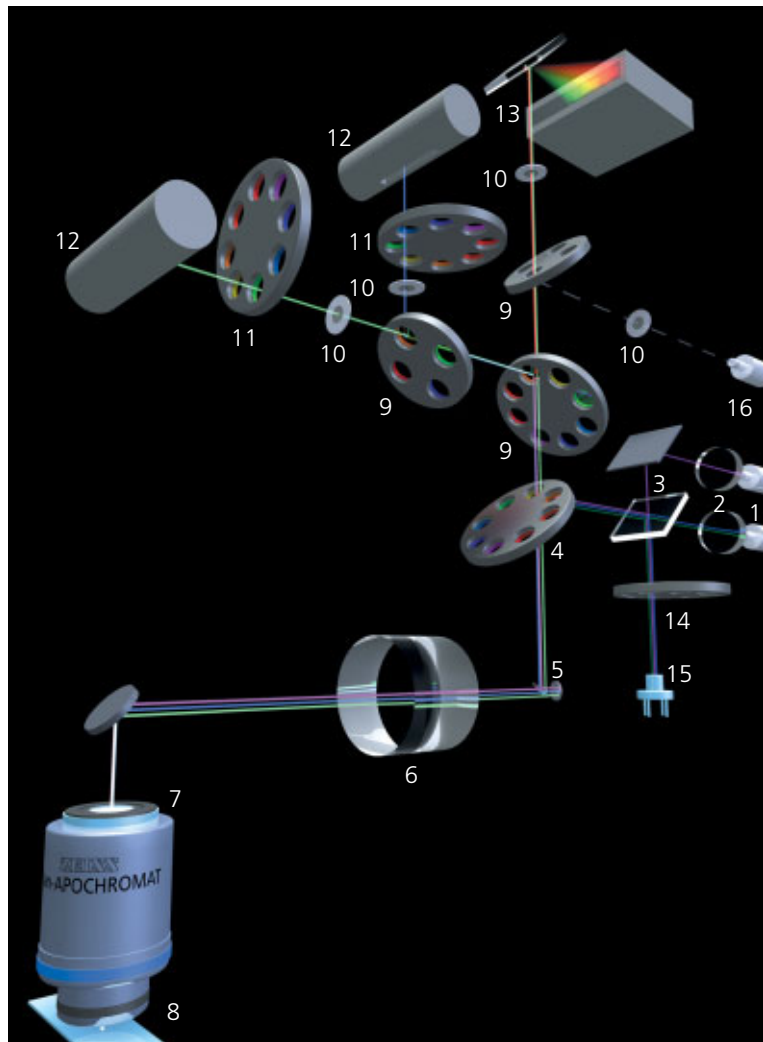
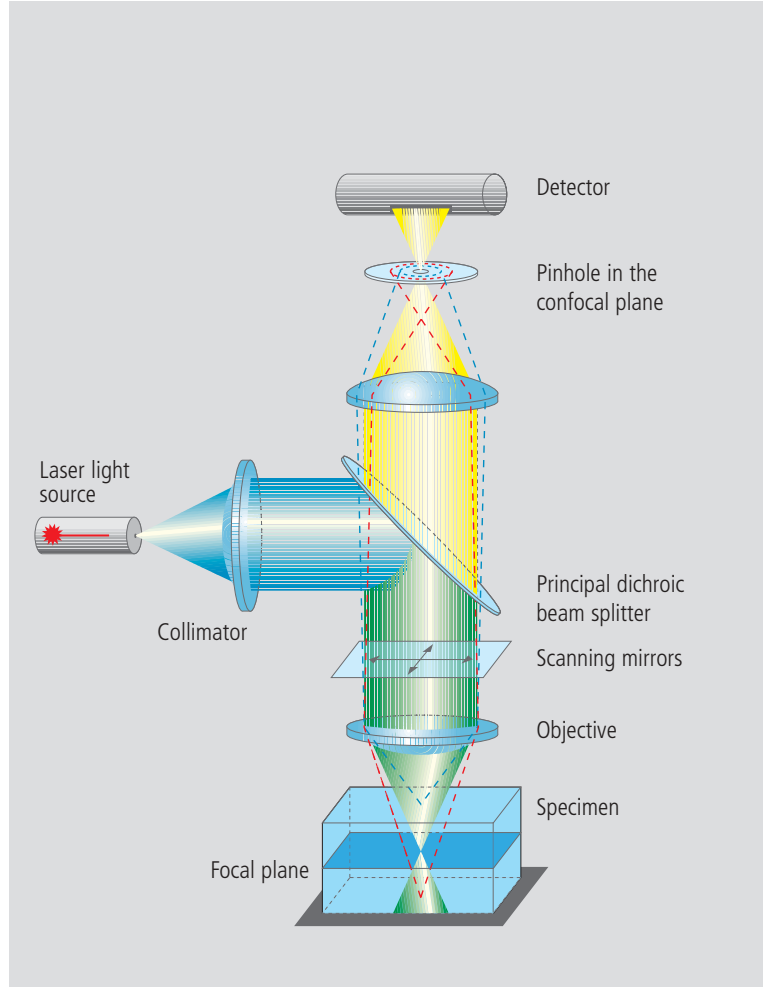


The Confocal Principle

In this chapter, the mode of operation of an LSM will be explained using a fluorescence-labeled specimen as an example. Fluorescent dyes, also known as fluorochromes, are used as markers in most biomedical applications to make the structures of interest visible. But laser scanning microscopes can just as well be combined with other microscopic contrast techniques such as reflected light or polarization.

An LSM can be easily understood as a modified light microscope supplemented by a laser module that serves as a light source, and a scanning head (attached to the microscope stand) that is used to detect the signal. Signal processing is effected by an electronic system contained in a box. The whole system is controlled by a computer.

To generate a confocal LSM image, let us first excite the fluorescence marker in a defined specimen area with a laser. For this purpose, monochromatic light from the laser module is coupled into the scanning head via a fiber optic. In the scanning head, the beam is made parallel by means of a collimator, and reflected into the microscope's light path by the principal dichroic beam splitter. The objective focuses the excitation beam onto a small three-dimensional specimen region called the excitation volume. The spatial extension of this volume is directly related to the system's resolving power. The greater the numerical aperture of the objective, the smaller the focal volume, and the higher the resolution. The position of the excitation volume can be shifted laterally (in X and Y) by means of two scanning mirrors, and vertically (in Z) with the microscope's focusing knob. The current Z position marks the system's focusing plane.

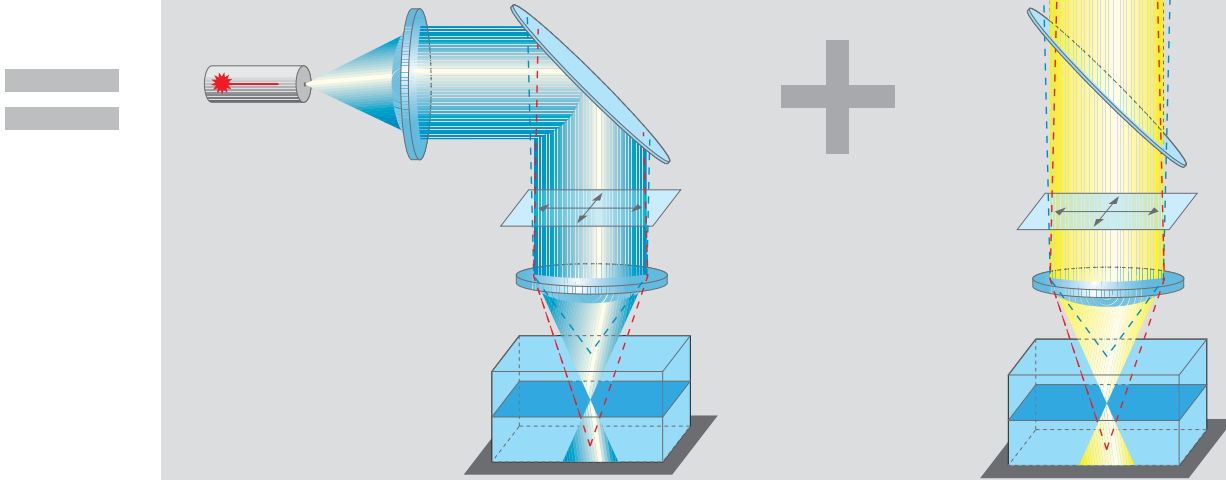


Excitation light path

The laser focused through the objective forms a double cone of excitation light inside the specimen. While the excitation intensity is strongest at the center of the double cone (in the focal plane), it is sufficiently high in the planes above and below the focus to excite fluorescence there, too.

Detection light path

The only fluorescence that reaches the detector is that emitted in the focal plane. Light originating from other planes is blocked by a pinhole diaphragm.



The laser light illuminating a particular detail of the specimen in order to excite fluorescence is focused by the objective into the focal plane. Fluorescence excitation and emission are most efficient within the focal volume. Therefore, the fluorescence from labeled structures in the focal plane forms a sharp image. The laser light, whilst less efficient, is still intensive enough to also excite fluorescently labeled structures above and below the focal plane. Light emitted there would be superimposed onto the sharp focal plane image and blur it. This is prevented by a pinhole diaphragm arranged in the ray path, which only permits light emitted in the focal plane to reach the detector.

The pinhole is essential to the generation of sharp images and for the optical sectioning capability. The very designation of confocal laser scanning microscopy refers to the pinhole, as this is in a plane conjugated to that of the focal plane (confocal plane). The thickness or Z dimension of an optical section can be set by motor-driven adjustment of the pinhole diameter. Fluorescence light from the focal plane, having passed the pinhole, is then detected by a photomultiplier. As an LSM image is formed sequentially, i.e. pixel by pixel, the detector does not require any spatial resolution. It merely measures the fluorescence intensity as a function of time. The image proper is formed only when the intensity measured by the detector is assigned to the corresponding site of the laser focus in the specimen. The laser beam is directed by the two independent scanning mirrors to scan the specimen in a line-by-line mode. The result of the scanning process is an XY image that represents a two-dimensional optical section of the specimen.

- 1 Fiber (from laser source)
- 2 Motor-driven collimators
- 3 Beam combiner
- 4 Primary dichroic beam splitter
- 5 Scanning mirrors
- 6 Scanning lens
- 7 Objective
- 8 Specimen
- 9 Secondary dichroic beam splitters
- 10 Pinholes
- 11 Emission filters
- 12 Photomultipliers
- 13 META detector
- 14 Gray filter
- 15 Monitor diode
- 16 Fiber output

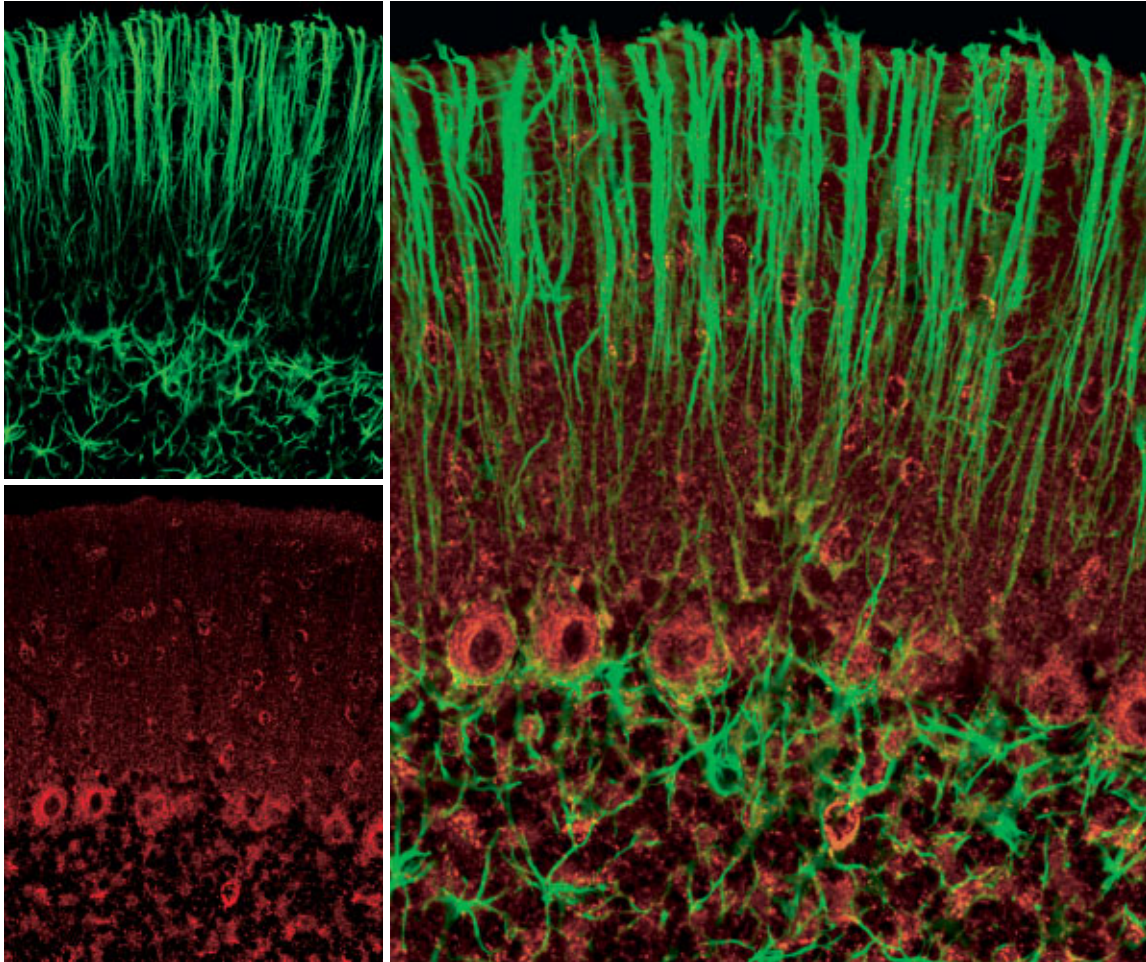
Two-Dimensional Images

For examining flat specimens such as cell culture monolayers, it is usually sufficient to acquire one XY image to obtain the desired information. The same applies if the specimen is a three-dimensional tissue section of which a single optical section is representative.

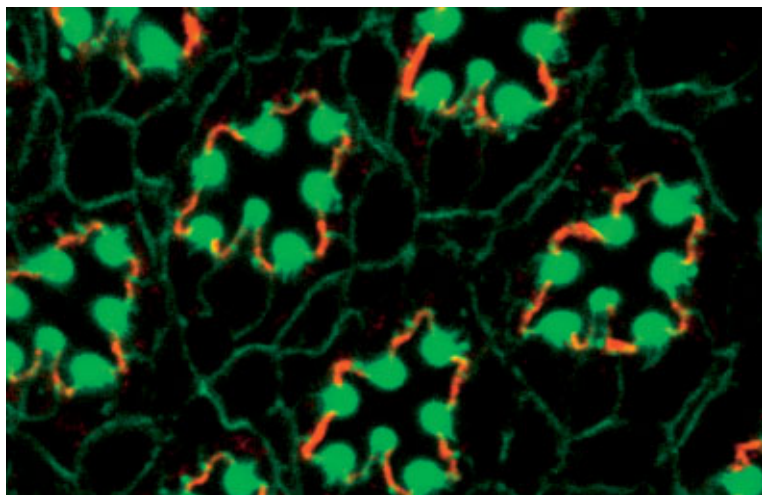
The thickness of the optical section (slice) and the focal position are selected so that the structures of interest are contained in the slice. The lateral resolution of a 2D image is defined by the pixel size in X and Y. The pixel size, in turn, varies with the objective used, the number of pixels per scan field, and the zoom factor. Pixels that are too large degrade resolution, whereas pixels too small require longer scanning times, bleach the specimen and generate superfluous data volumes. The optimum pixel size for a given objective and a given zoom factor can be set by selecting the number of pixels with a mouse click.

The procedure for a two-dimensional image

- 1** Position and focus on the specimen in the *Visual* mode
- 2** Select the configuration to match the fluorochromes used
- 3** Define pixel resolution, scanning speed and, where required, *Average Mode*
- 4** Set the optical slice thickness by means of the pinhole diameter
- 5** Adapt the dynamic range to the specimen; automatically via *Find*, or manually via *Gain* and *Offset*
- 6** Adapt the scanning field to specimen substructures, using the *Crop* function



*Confocal section through the cerebellum of a rat.
Green: astroglia cells (GFAP labeling);
red: superoxide dismutase in neurons.*



*Double labeling of a Drosophila retina.
Green: actin; red: Crumbs.
Specimen: Dr. O. Baumann,
University of Potsdam,
Germany.*

Three-Dimensional Images

To record the three-dimensional structure of a specimen, several two-dimensional optical sections are made in different focal planes. The result is an XYZ image stack, which can be visualized, processed and analyzed.

The optical section is selected by shifting the position of the focus in the specimen. This can be effected by moving either the objective or the specimen stage along the Z axis, according to the microscope stand design. Whether the image acquisition exhausts the resolving power given by the objective's numerical aperture depends on the thickness of the optical slice and on the spacing of two successive sections (the Z interval). According to the Nyquist criterion, the optimum Z interval is equal to half the optical slice thickness. If the pinhole diameter is selected to equal one Airy unit (1 AU), an optimum compromise between contrast and intensity is achieved for the XY image. The respective settings can be made by a mouse click in the software.

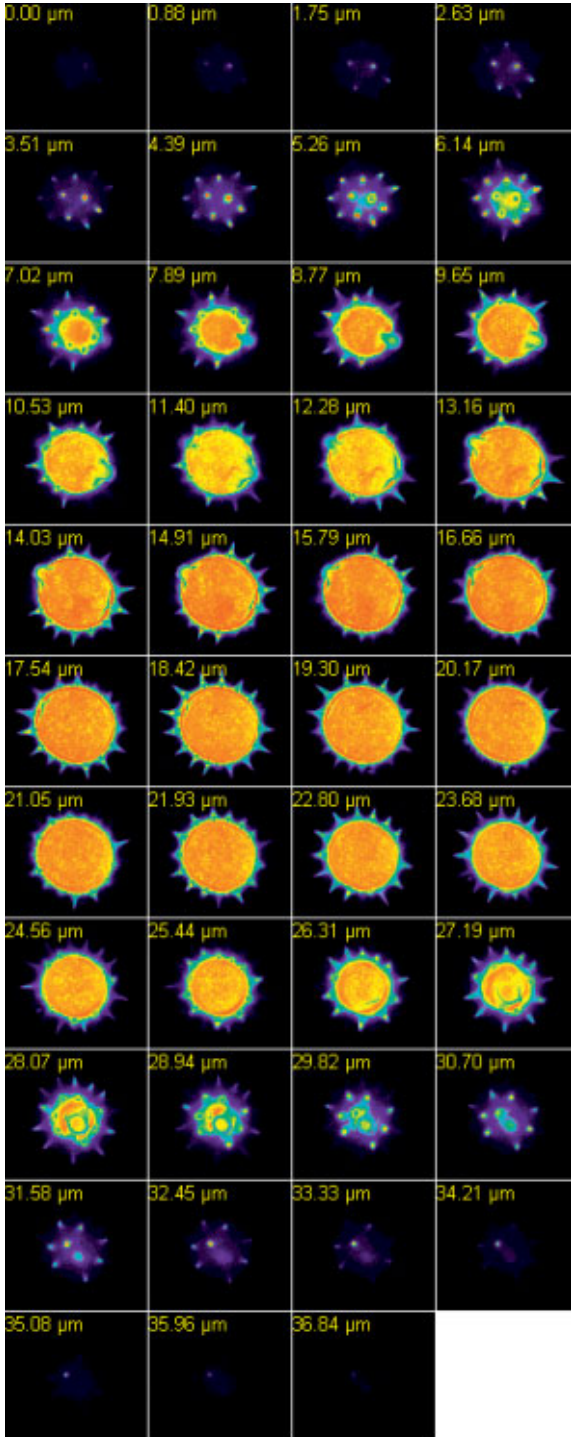
If the sample to be examined is labeled with more than one fluorochrome, it is necessary to adjust the optical slice thicknesses of the various image channels. The slice thickness is a function of the numerical aperture of the objective, the wavelength used, and the pinhole diameter. It differs for channels detecting light of different wavelengths. In the systems of the Zeiss LSM 510 family, every detector is equipped with a separate pinhole. This makes it easy to equalize the optical slice thicknesses in the software – an important condition for 3D colocalization analyses or for reconstructing 3D images.

Once a 3D stack of images has been recorded, the user has various presentation options. The data may be displayed as a gallery of depth-coded images or as orthogonal projections of the XY, XZ and YZ planes. To create a 3D impression on a 2D monitor, animations of different viewing angles versus time, shadow projections, and surface rendering techniques are possible.

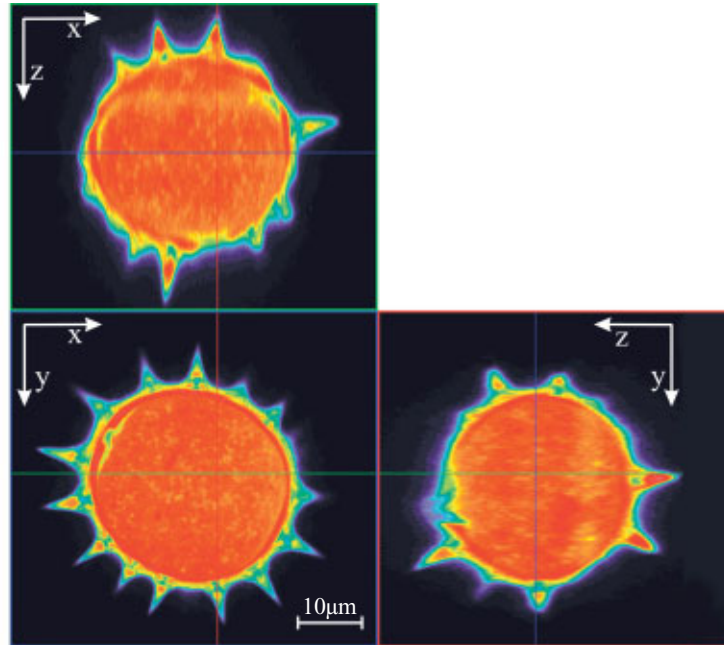
The procedure for a three-dimensional image

- 1** Optimize the recording conditions for an XY image at the center of the three-dimensional specimen (see box for 2D images)
- 2** Define the *Start* and *Stop* stack limits in the *Z Setting* menu
- 3** Define the optimum Z interval in the *Z Slice* menu
- 4** Acquire the Z stack
- 5** Display and analyze the stack in one of the *Gallery*, *Ortho* or *Cut* display modes
- 6** With multiple-labeled specimens, equalize the optical slice thicknesses in the *Z Slice* menu

Three-dimensional specimen



XYZ image stack of a pollen grain. A series of XY images acquired in different focus positions represents the Z dimension of the specimen.



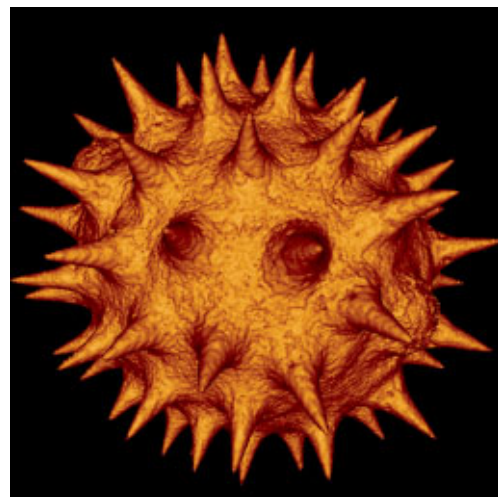
The orthogonal projection of the three-dimensional image data stack permits the raw data stack to be sectioned anywhere in any of the three mutually perpendicular planes.

Bottom left (above): Horizontal section through the center of the pollen grain (XY image).

Top: Projection of a vertical section along the horizontal axis in the XY image.

Bottom right: Vertical section along the vertical axis in the XY image.

Surface-rendered projection of the pollen grain.



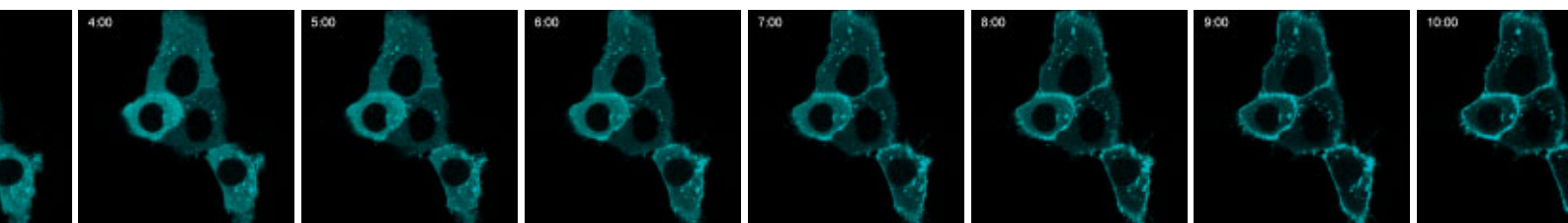
Time Series

Dynamic processes in living specimens can be recorded by means of time series. Data thus acquired can be analyzed “off-line”, i.e. after image acquisition, or “on-line”, i.e. right during the experiment, for example in the Online Ratio mode.

Time series are defined by a start time and the time interval between two successive images. The series can be started by a mouse click, automatically at a preselected time, or by some external trigger. To analyze a time series, the Physiology software option allows fluorescence intensity changes to be quantified in defined regions of interest (ROIs).

Within a time series, the LSM 510 permits selective, point-accurate illumination of ROIs with laser light.

This function is useful for generating a photobleaching routine within a FRAP experiment (fluorescence recovery after photobleaching), for analyzing dynamic processes, and for the photoactivation or photoconversion of suitable fluorochromes. Complex time series experiments, with different images to be taken at different sites within a specimen according to a defined time pattern, can be defined by means of a special software option.



The procedure for a time series

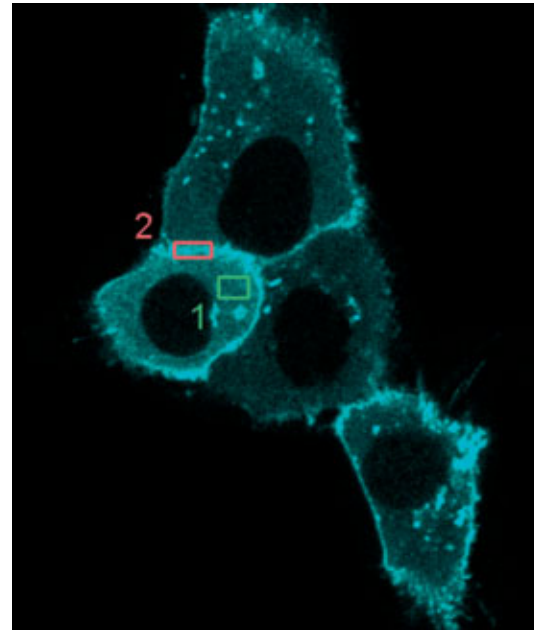
- 1** Define the image dimensions to be recorded versus time (*XY image, Z stack, λ stack*)
- 2** Optimize the recording conditions at minimum laser output to avoid or minimize bleaching
- 3** Define the number of images to be taken and the time interval between two successive images (*Time Interval or Time Delay*)
- 4** Combine with a photobleaching routine if required: define the region to be bleached, the laser line and its power, the number of bleaching actions, and the bleaching start time within the series
- 5** Start the time series with the Start button, at a preselected time, or by an external trigger

Evaluation of the experiment

Selection of ROIs within the specimen.

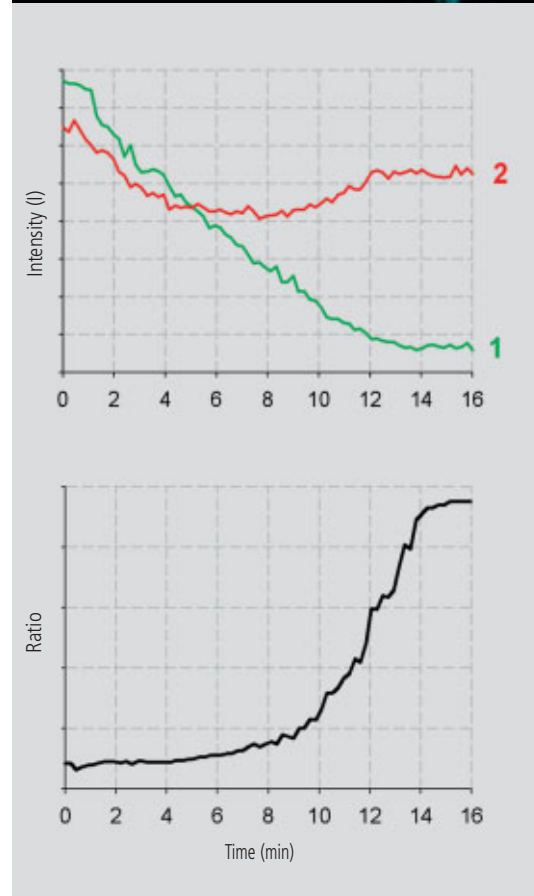
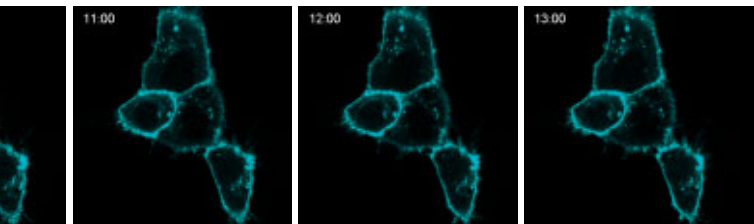
ROI 1: Cytosol

ROI 2: Cytoplasmic membrane



Investigation of protein movements

Time series of PKC-GFP transfected HeLa cells. The stimulation of the cells with PMA at the time $t=1$ min leads to a redistribution of PKC from the cytosol to the cytoplasmic membrane (times in minutes).
Specimen: Dr. S. Yamamoto, Medical University of Hamamatsu, Japan.



The individual intensities (upper graph) and the ratio of intensities in the two ROIs marked in the top picture (lower graph) illustrate PKC redistribution. Colors are assigned correspondingly.

Multifluorescence – The Crosstalk Problem and Its Solution

If a specimen is labeled with more than one fluorochrome, each image channel should only show the emission signal of one of them.

If, in a specimen labeled red and green, part of the green light is detected in the red channel, the phenomenon is known as crosstalk or bleed-through. This may lead to misleading results, especially in colocalization experiments.

One can distinguish between two kinds of crosstalk: emission and excitation crosstalk.

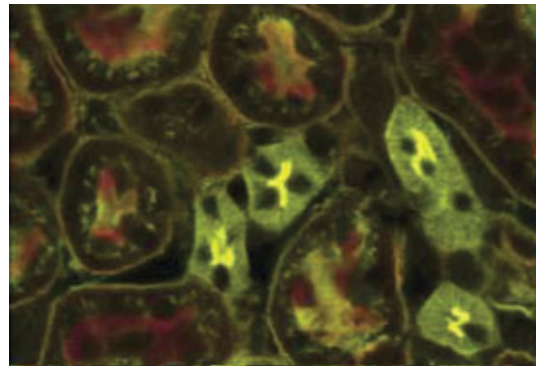
In a pure emission crosstalk between two fluorochromes A and B, the two emission spectra will overlap, but the laser lines will excite the dyes independently of each other; i.e. there is no overlap of the excitations.

Excitation crosstalk would occur if the laser that excites fluorochrome A also partially excited fluorochrome B.

The problem of emission crosstalk can be solved by sequential excitation and detection (Multitracking) of the fluorochromes. In case of a combination of excitation and emission crosstalk, additional spectral information is needed for separating the emission signals.

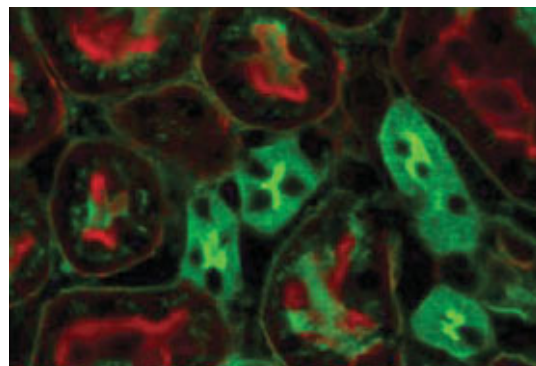
Emission crosstalk

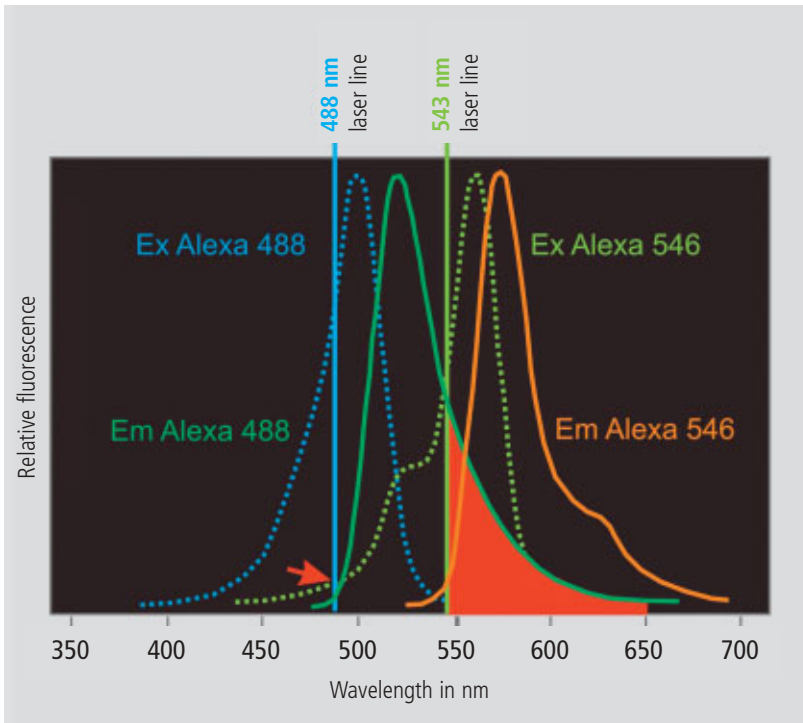
Section through a mouse kidney, double-labeled with Alexa 488 (wheat germ agglutinin) and Alexa 568 (phalloidin). Simultaneous excitation with 488 and 543 nm. The emission of Alexa 488 is detected in both the green (BP 505-530 nm) and red (BP 560-615 nm) channels. Because of this bleed-through, the areas labeled with Alexa 488 appear yellow in the superposition and could be misinterpreted as colocalization with the Alexa 568.



Elimination of emission crosstalk by Multitracking

If Alexa 488 and 568 are excited and detected sequentially, no green signal is detected in the red channel. Structures labeled with Alexa 488 appear green in channel superposition.





Emission crosstalk of Alexa Fluor 488 and 546

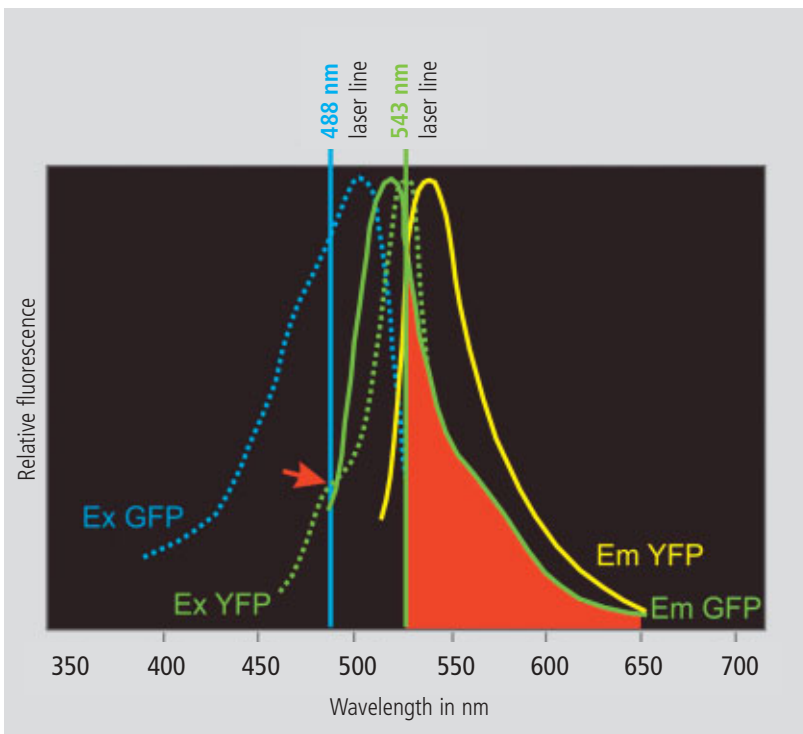
The excitation efficiency of the two fluorochromes is determined by the point of intersection between the laser line used and the excitation spectrum (dotted line).

Accordingly, Alexa Fluor 488 is excited to about 80 %, Alexa Fluor 546 to about 60 %.

At a level of about 5%, the excitation spectrum of Alexa Fluor 546 is also intersected by the 488 nm laser line (arrow). Theoretically, this constitutes excitation crosstalk, as one line excites both markers, but it is inefficient enough to be negligible.

Contrary to this, the emission spectra of the two dyes overlap significantly.

The red area marks the emission crosstalk of Alexa Fluor 488 occurring if Alexa Fluor 546 is detected to the right of the 543 nm laser line.



Combined excitation and emission crosstalk

If GFP is used together with YFP, the emission spectra will overlap considerably.

The red area marks the emission crosstalk between GFP and YFP occurring if YFP is detected to the right of the 514 nm laser line.

In addition, there will be a pronounced excitation crosstalk. The 488 nm line excites not only GFP but also YFP to an efficiency of about 30 % (arrow).

Source: <http://home.ncicrf.gov/ccr/flowcore/welcome.htm>; modified

Spectral Imaging

The acquisition of spectral data becomes necessary where the overlapping emission signals of multiple-labeled specimens have to be separated, or where the cellular parameter to be measured is coded by changes of the emission spectrum (e.g., FRET and ratio imaging of ion concentrations).

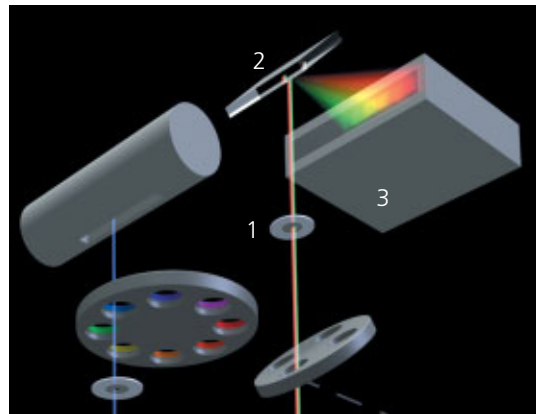
The LSM 510 META is a system for the fast acquisition of images of high spectral resolution. The hardware enabling this functionality consists of a spectrally dispersive element, a photomultiplier (PMT) with 32 parallel detection channels (META Detector), and special electronic circuitry for detector control and signal amplification.

Whereas the beam paths for conventional and META detection are identical on the excitation side, the emission beam for spectral detection, after having passed the pinhole, hits a reflective grating. The grating spreads the beam into a spectrum and projects it onto the surface of the linear detector array. Each of the 32 PMT elements in that array thus registers a different part of the spectrum, each part having a width of 10 nm. The result is a lambda stack of XY images in which each image represents a different spectral window.

META Detector

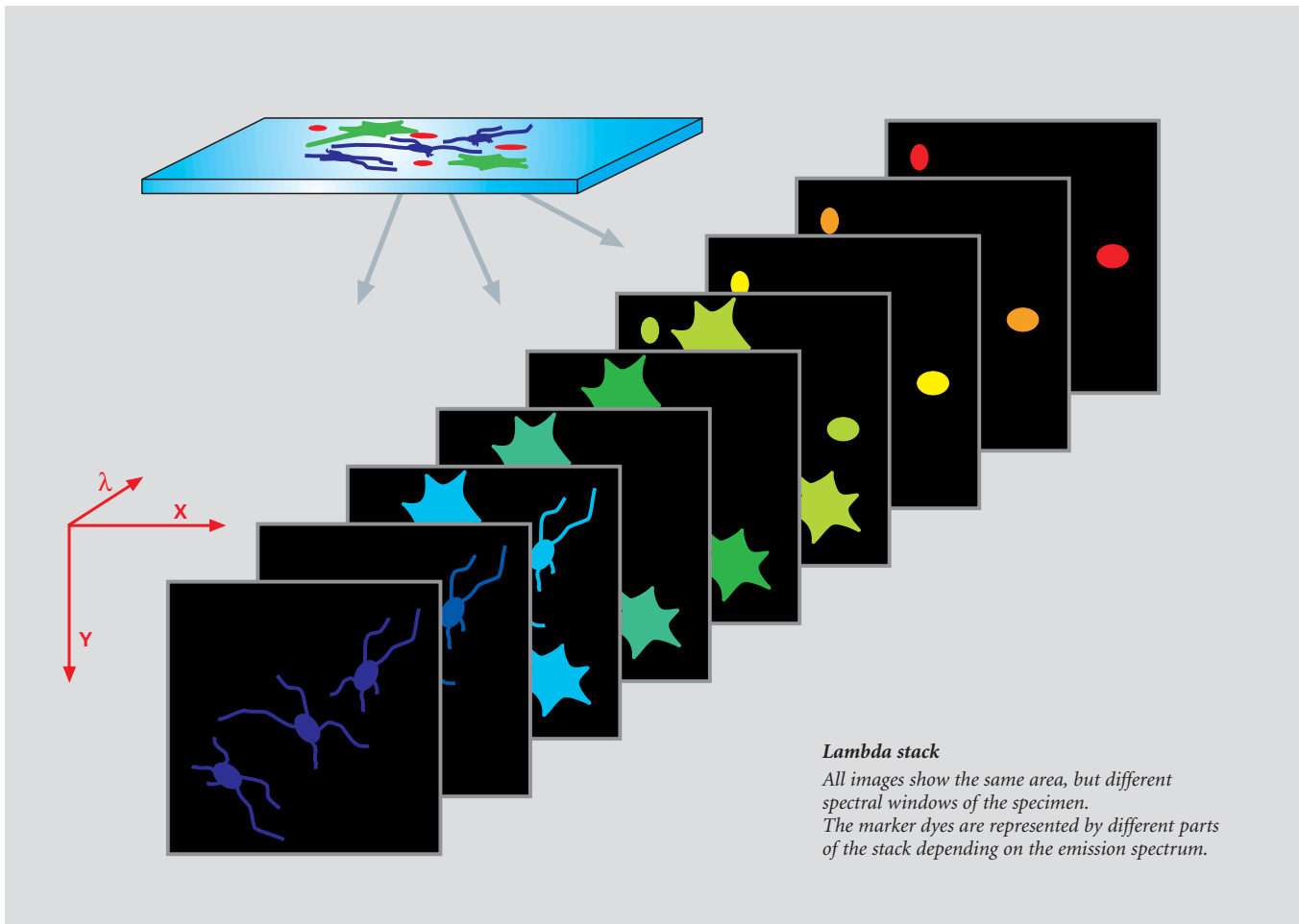
Part of the beam path in the LSM 510 META scanning head

- 1 Confocal pinhole
- 2 Reflective grating for spectral dispersion
- 3 META Detector with 32 separate PMT elements



The procedure for a lambda stack

- 1 Select the spectral range in the *Lambda-Mode*
- 2 Activate the excitation laser lines
- 3 Carefully control the dynamic range to avoid over- and underexposed pixels (*Range Indicator*)
- 4 In multiple-labeled specimens, vary the power of the respective laser lines instead of the *Amplifier Gain*, in order to match the signal intensities of the fluorochromes
- 5 Record the lambda stack
- 6 Display the data in one of the modes: *Gallery, Single, Slice, Max* or λ -coded



By connecting adjacent detector elements (binning), the spectral width of the images can be extended. From a lambda stack, the intensity of the signal for each pixel of the image can be extracted as a function of wavelength. These spectral "fingerprints" can easily be obtained for any image area by means of the Mean of ROI function. Lambda stacks can be recorded as time series, Z stacks, or as Z stacks versus time. In the last-named case, the result would be a five-dimensional image file with the coordinates, X, Y, Z, lambda and time.

The META Detector is good not only for recording lambda stacks, but also as a channel detector in the conventional mode. By binning the respective detector elements in this mode, the optimum spectral bandwidth can be adjusted for any fluorescent dye.

Spectral Imaging

Emission Fingerprinting

Emission Fingerprinting is a method for the complete separation (unmixing) of overlapping emission spectra. It is used with specimens labeled with more than one fluorescent dye, exhibiting excitation and emission crosstalk.

The typical raw data for Emission Fingerprinting are lambda stacks. The previous chapter described how they are recorded by means of the META Detector. The second step is to define reference spectra for all spectral components contained in the specimen. As a rule, these are dyes internationally used for labeling the specimen. Other possible components are autofluorescent and highly reflecting structures. Autofluorescences, in particular, often have rather broad emission spectra that overlap with the fluorescent markers; this makes them an added source of "impurities" degrading the signals in conventional laser scanning microscopy.

With Emission Fingerprinting, autofluorescences are simply included in the unmixing process. The user can subsequently decide between switching the autofluorescence channel off and using it to obtain structural information possibly contained in the specimen.

The reference spectra can either be loaded from a spectra database, or directly extracted from the lambda stack. For the latter version, the user has two options. One is to define spectra via ROIs. The other uses a statistical method, Automatic Component Extraction (ACE), to find the reference spectra. In either case, the images of the lambda stack must contain structures marked with a single fluorochrome only.

The third step of Emission Fingerprinting is Linear Unmixing, which converts the lambda stack into a multichannel image. Each spectral components of the specimen is then displayed in one channel only. The accuracy of the technique allows the complete unmixing even of such dyes whose spectra have almost identical emission maxima.

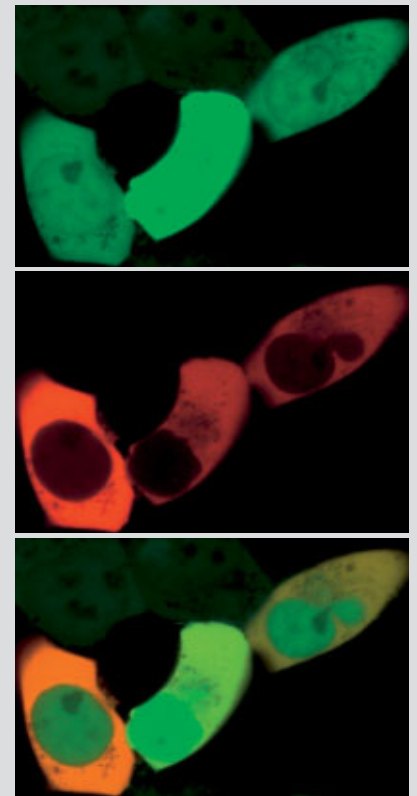
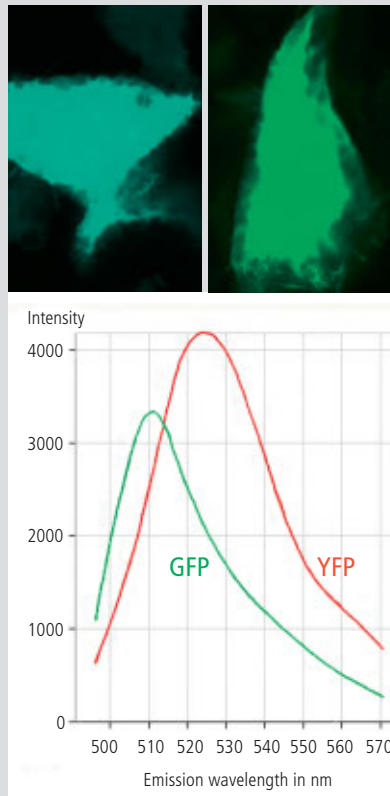
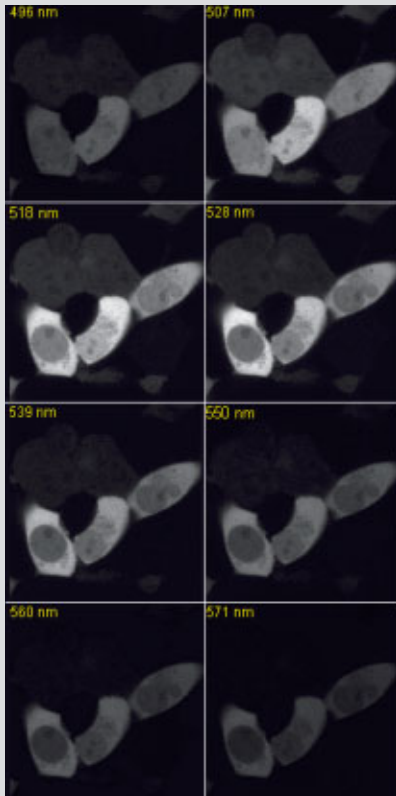
Linear Unmixing

Linear mathematical algorithm for spectral unmixing.

If we regard a pixel of a lambda stack that represents a locus in the specimen where three fluorescent dyes A, B and C with their spectra $S(\lambda)_{\text{dye A, B and C}}$ overlap, the cumulative spectrum $\Sigma S(\lambda)$ measured can be expressed as

$$\Sigma S(\lambda) = [\textit{intensity} \cdot S(\lambda)]_{\text{dye A}} + [\textit{intensity} \cdot S(\lambda)]_{\text{dye B}} + [\textit{intensity} \cdot S(\lambda)]_{\text{dye C}}$$

By means of known reference spectra $S(\lambda)_{\text{dye A, B and C}}$, the equation can be solved for the intensities of the dyes A, B and C, which yields the intensity shares of the three dyes for this pixel. If this calculation is made for each pixel, a quantitatively correct 3-channel image results, in which each channel represents a single dye.



The 3 Steps of Emission Fingerprinting

1 Recording of a lambda stack

The illustration shows an 8-channel image of a cell culture transfected with GFP and YFP. Each image shows the mean wavelength of the channel.

2 Definition of reference spectra

The reference spectra were obtained by means of lambda stacks of cells single-marked with GFP and YFP, respectively. Top: Lambda-coded projections of a cell marked with GFP (left) or YFP (right). Bottom: Reference spectra for GFP (green) and YFP (red).

3 Linear Unmixing

Using the reference spectra from the lambda stack, the *Linear Unmixing* function generates a two-channel image, in which each channel represents only one of the two fluorochromes. Top: GFP
Center: YFP
Bottom: Both channels superimposed

Spectral Imaging

Channel Unmixing

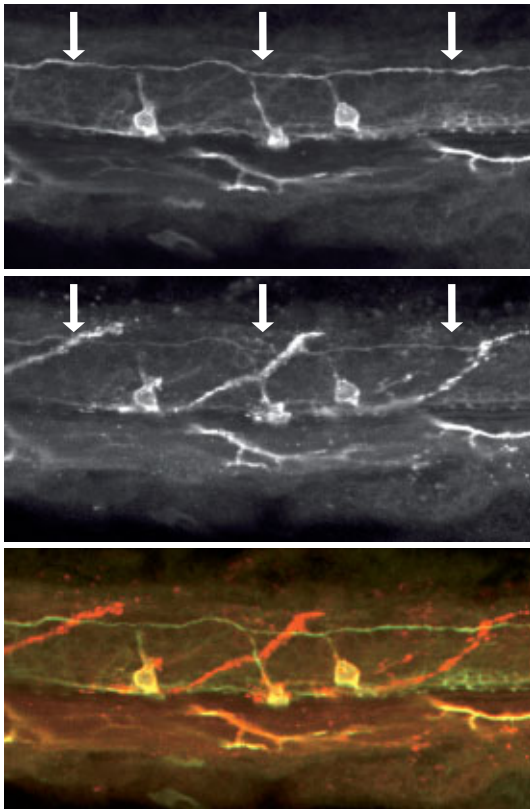
If the emission spectra of fluorescent markers overlap only slightly, the signals can be separated with the *Channel Unmixing* function.

As raw data for unmixing in this case, it is sufficient to have multichannel images in which one of the marker dyes dominates in each channel. Such images can be acquired without the META Detector, i.e. with an LSM PASCAL, LSM 510 or a CCD camera.

Channel Unmixing also allows unmixing based on the excitation behavior of dyes, if the raw data are multichannel images in which the channels differ only by their excitation wavelength.

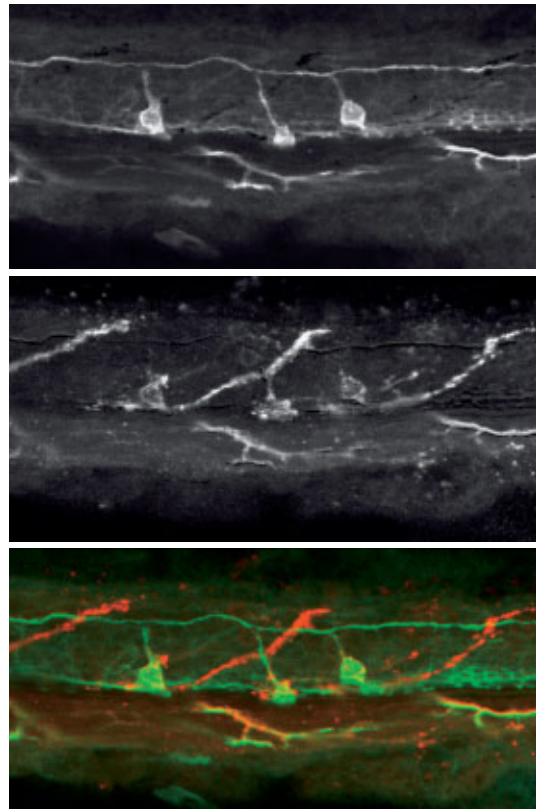
Double labeling of the nervous system of a zebra fish embryo

Two-channel single-track images with emission crosstalk. The nerve labeled with Alexa 488 can be discerned (arrows) in the green (top) and, faintly, in the red channel (center). Bottom: Superposition of the two channels.



The same images after Channel Unmixing.

The Alexa 488-positive nerve is visible in the green channel (top) only but vanished from the red one (Center). Bottom: Superposition of the two channels.



Specimen: Prof. M. Bastmeyer, Friedrich Schiller University of Jena, Germany.

Online Fingerprinting

The functionality of *Online Fingerprinting* can be used to separate overlapping emissions even while a time series is being recorded. This may be of decisive importance where dynamic processes are investigated.

Here, a reference spectrum is assigned to each image channel before image acquisition starts. During the experiment proper, lambda stacks are acquired and immediately unmixed in a background operation. The user sees the unmixed multichannel image during the acquisition of the time series. *Online Fingerprinting* is of advantage especially in spectral FRET experiments and in studies of dynamic processes with fluorescent proteins.

Visualization of FRET by means of acceptor photobleaching

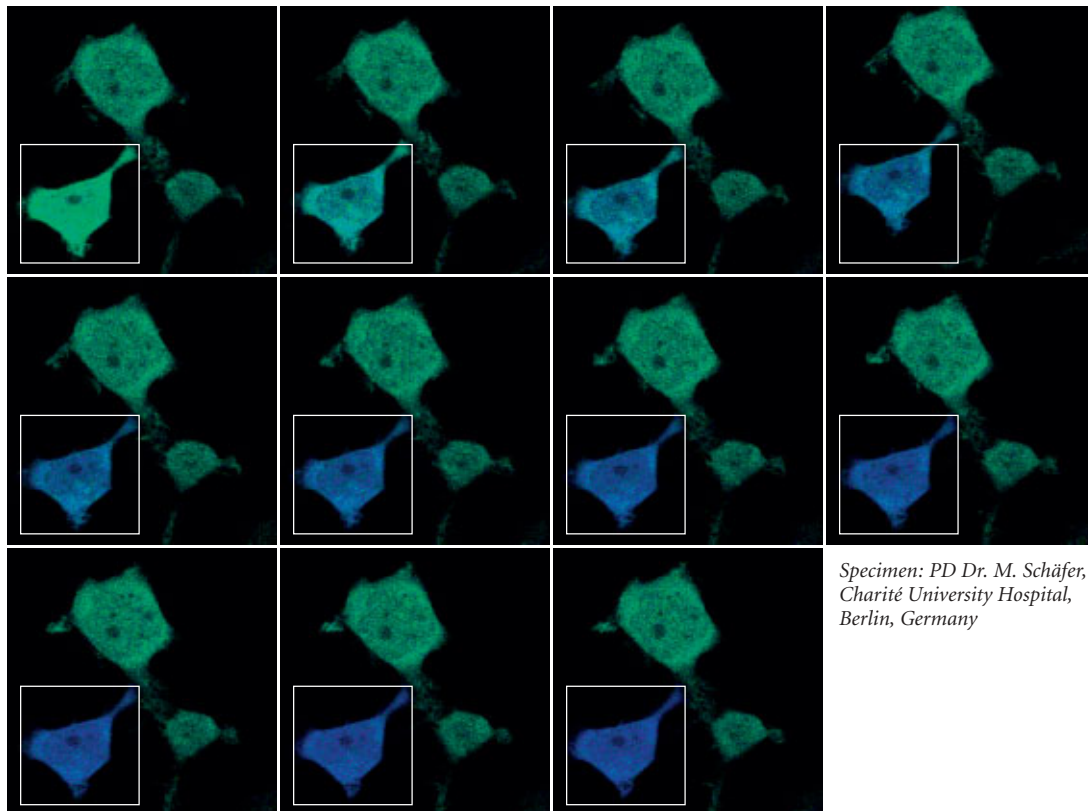
Expression of a FRET-positive protein construct (CFP linker citrin) in HEK 293 cells.

Recording conditions: Simultaneous excitation with 458 and 514 nm.

Spectral detection from 462 to 655 nm in Lambda Mode.

Online Fingerprinting and simultaneous display of the two-channel image (CFP blue, citrin green).

During the combined time- $\&$ -bleaching series (bleaching region marked), citrin (green channel) as a FRET partner is destroyed by intensive irradiation with 514 nm. The decrease in FRET is visible as an increase in CFP fluorescence (blue channel).



Specimen: PD Dr. M. Schäfer,
Charité University Hospital,
Berlin, Germany

Spectral Imaging

Excitation Fingerprinting

By means of tunable excitation lasers such as those used in multiphoton systems, it is possible to detect also the excitation spectra of fluorochromes. These can be used for unmixing as an alternative to emission spectra.

Multiphoton systems are a special class of confocal laser scanning microscopes, distinguished from classical one-photon systems essentially by an additional light source, known as a multiphoton or NLO (non-linear optics) laser.

The infrared (IR) light emitted by such lasers can penetrate tissues to greater depths than visible light can. Due to its low phototoxicity, IR light is suitable for long-time observation of live samples. Usually, the emission wavelength of these lasers can be varied continuously to excite the respective fluorochrome used in the multiphoton mode.

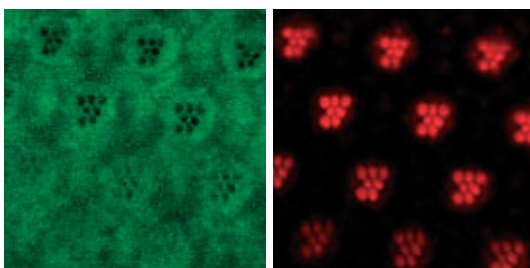
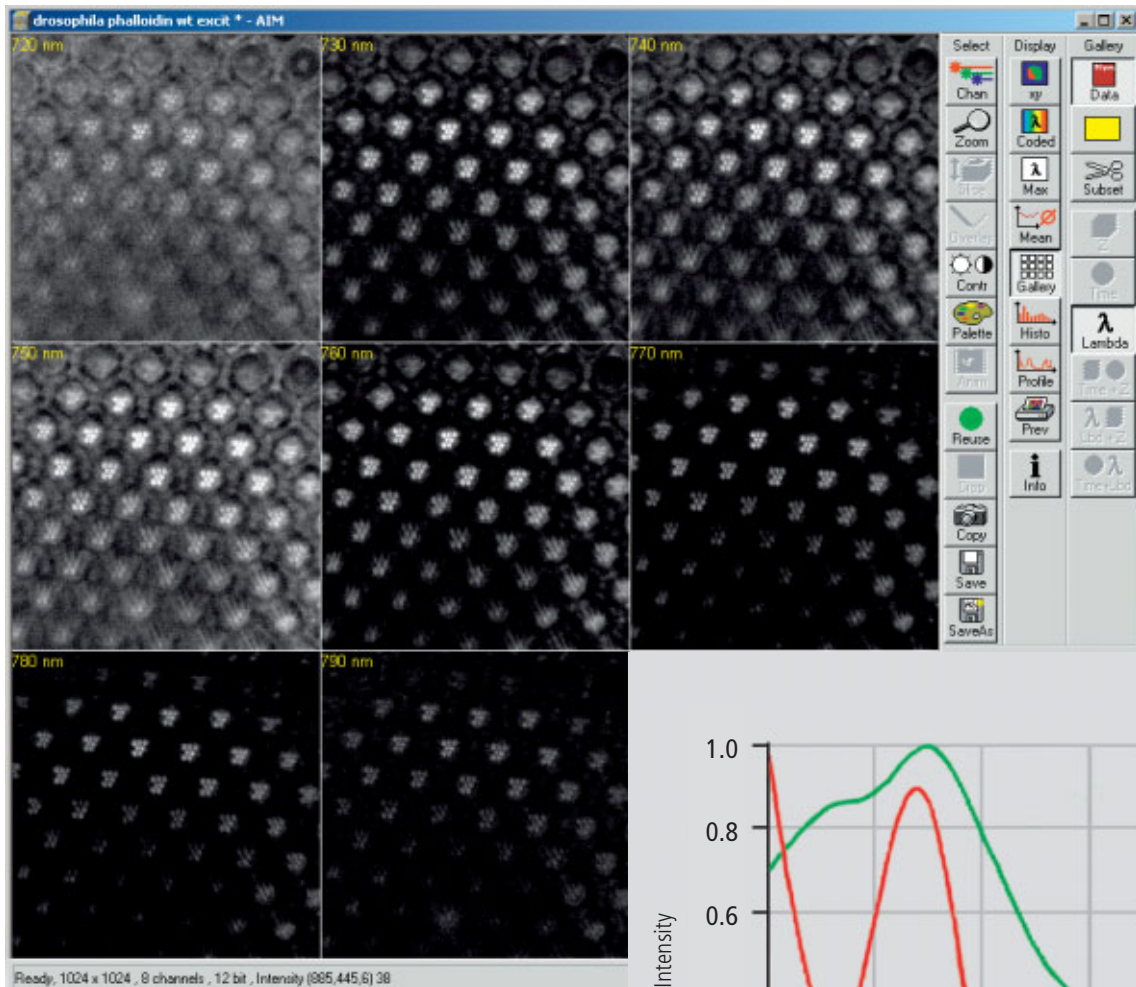
In *Excitation Fingerprinting*, this property is used for the acquisition of excitation lambda stacks. For that purpose, the multiphoton laser is controlled by the LSM software to shift its excitation wavelength by a defined interval before every new image. The image stacks thus recorded can be used for the unmixing of spectral components differing by their excitation properties, analogously to the (emission) lambda stacks described before. For more information on multiphoton microscopy, refer to the literature cited on the rear cover.

The procedure for Excitation Fingerprinting

- 1** Define an excitation lambda stack (wavelength range and interval size) in the *Excitation Fingerprinting* macro
- 2** Record the excitation lambda stack
- 3** Define the reference spectra via single-labeled specimen regions, single-labeled reference samples, or by using the *ACE* function
- 4** Run *Linear Unmixing*



Excitation Fingerprinting separates widely overlapping emission signals by their excitation spectra.



Retina of a *Drosophila* fly, labeled for actin (Alexa Fluor 586 phalloidin); autofluorescence and emission signal can be cleanly separated by Emission Fingerprinting.

Specimen: PD Dr. O. Baumann, University of Potsdam, Germany

Courses

Laser scanning microscopy and related techniques

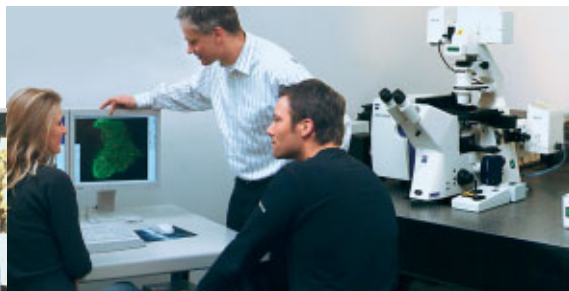
Laser scanning microscopy has become a mainstream technique in biomedical research. Thorough familiarity with its theoretical principles and application know-how is a prerequisite for successful experimentation.

Carl Zeiss offers seminars that teach the fundamental theory and explain biomedical research methods, followed by intensive practical hands-on training in small groups.

The participants in these courses have access to various combinations of microscopes and latest generation LSM systems made by Carl Zeiss.

There is no better way to efficiently acquire new know-how and skills in using up-to-date LSM equipment.

- **Laser scanning microscopy in biomedical applications**
- **Multiple fluorescence labeling and quantitative colocalization**
- **Dynamic investigation of living cells – FRAP, FLIP, FRET, photoactivation and photoconversion**
- **Confocal laser scanning microscopy in materials research & quality inspection – principles and applications**
- **Fluorescence correlation spectroscopy in biomedical research**



For details, see
www.zeiss.de/courses

Summary

Modern laser scanning microscopes are versatile tools for visualizing cellular structures and analyzing dynamic processes in biomedical research.

Apart from mere imaging, Carl Zeiss laser scanning microscopes are designed for the quantification and analysis of image-coded information. Among other things, they allow easy determination of fluorescence intensities, distances, areas and their changes over time. The LSM 510 META, in particular, is capable of quickly detecting and quantitatively unmixing the spectral signatures of fluorescent dyes that closely resemble each other.

Many software functions analyze important parameters such as the degree of colocalization of labeled structures, or the ion concentration in a specimen.

With their capabilities for acquiring, evaluating and presenting experimental data, LSM systems made by Carl Zeiss are tailored to the requirements of scientists of today and tomorrow.

REFERENCES

Amiri H., Schulz G., Schaefer M. (2003)
FRET-based analysis of TRPC subunit stoichiometry.
Cell calcium, 33(5-6):463-70.

Carl Zeiss (2000)
Confocal Laser Scanning Microscopy – Principles. 45-0029 e/09.03

Carl Zeiss (2002)
Colocalization – Analysis and Visualization.
45-0012 e/11.02

Carl Zeiss (2002)
Spectral Separation of Multifluorescence Labels with the LSM 510 META.
40-546 e/05.02

Diaspro A. (2001)
Confocal and Two-Photon Microscopy : Foundations, Applications and Advances,
Wiley-Liss, New York

Dickinson M.E. (2001)
Multi-spectral imaging and Linear unmixing add a whole new dimension to laser scanning fluorescence microscopy.
Bio Techniques 31/6, 1272-1278.

Gordon G.W. (1998)
Quantitative Fluorescence Resonance Energy Transfer Measurements Using Fluorescence Microscopy.
Biophys J, May 1998, p. 2702-2713, Vol. 74, No. 5

Pawley J.B. (1995)
Handbook of Biological Confocal Microscopy.
Plenum Press, New York

Selvin P.R. (2000)
The renaissance of fluorescence resonance energy transfer. *Nat Struct Biol.* 7(9):730-4. Review.

LINKS

Carl Zeiss website on contrasting techniques in light microscopy
www.zeiss.de/contrasts

EAMNET website on FRAP
www.embl-heidelberg.de/eamnet/html/teaching_modules.html

For further information, please contact:

Carl Zeiss
Advanced Imaging Microscopy
07740 Jena, Germany
Phone: +49 36 41-64 34 00
Fax: +49 36 41-64 31 44
E-Mail: micro@zeiss.de
www.zeiss.de/lsm

IMPORTANT NOTES FOR CHAPTER 4

Tile scan with overlapping borders of single images	When performing a tile scan with a defined overlap of > 0 the functions Position and Stage in the 2D View tab / Dimensions are not available.
Changes to the operating system	Do not update Windows Vista, the version installed from the factory is already optimized to run with ZEN 2010. Automatic installation of patches might lead to conflicts with ZEN.
Dye-spectra of deselected channels stay in the display	The spectra will stay until a new dye is chosen for this channel.
FCS model for PCH	In the PCH model decimals can be entered into the F1, F2 and F3 input boxes the following way: for example instead of typing 0.361, type in 361, then position the cursor before the digit 3, then enter the dot.
LSM 710 and LSM 780 with 32-channel spectral detector	The light path will remain in lambda mode when the Extract function in the unmixing image viewer is activated and one of the selected bands exceeds the detection range of the LSM 710 / LSM 780 Quasar detector.
LSM 710 and LSM 780 with 'In Tune' laser	<p>While the 'In Tune' laser is busy due to a wavelength change the wavelength display is not marked in red as is indicated for NLO lasers (64-bit systems only).</p> <p>The automatic selection of the main dichroics in basic mode of the Light path tool window (Show all mode not activated) can give an unexpected result for the case of a line wise multi-track acquisition, where the 405 nm laser, a line from the 'In Tune' laser and a line from one of the visible lasers are selected. The main dichroics can block the light of the visible lasers.</p> <p>In this case switch to Show all mode and select a neutral density beam splitter. To achieve good laser suppression it is recommended to use the frame-wise multi track mode.</p> <p>The automatic selection of the main dichroics will consider the currently selected wavelength of the 'In Tune' laser even if the laser is currently not in use. This might block the laser wavelengths of other visible light laser lines. The work-around is to tune the 'In Tune' laser to the lowest possible wavelength.</p>
Scan speed uni versus bidirectional (for all systems)	For some scan speeds the acquisition with two tracks in line wise multi-track mode is faster in uni-directional mode than in bi-directional mode.
Switching and adding of tracks	The switching between tracks and the adding of a new track in the Illumination Setup tool window in the left screen area works in a slower mode compared to ZEN 2008.
Auto Save function	When a time series with the Auto Save function active and LSM-file format selected is stopped manually during acquisition, the reloaded image series will display arbitrary data instead of empty images for the frames which have not been acquired.

Auto Save, Stich, Focus Speed and Parafoal Correction functions	These functions are described within the context sensitive help in the software but are not described in the printed manual LSM 7 MP.
Systems with motorized stage and license StitchArt	The display of tile scan images with overlap will threat the image coordinates for the individual tiles and not for the entire image. The intensity display in the status bar will display the coordinate relative to the start of the tile and not relative to the start of the entire image.
LSM 7 MP with two NLO lasers	<p>Bleaching in simultaneous mode is slower than expected when the wavelength of the imaging laser in the Bleach tool window has a different wavelength than in the Channels tool window. The software will tune the laser to the selected wavelength even if the laser line is not in use.</p> <p>To achieve fast simultaneous bleaching:</p> <ul style="list-style-type: none">– Switch the laser line of the imaging laser in the Bleach tool window on.– Enter the same wavelength as for in the Channels tool window.– Switch the laser line off again.

CHAPTER 4 SYSTEM OPERATION

CONTENTS

		Page
1	PURPOSE	7
1.1	Software	7
1.2	Convention for the Text in this Manual	7
1.3	Backup.....	8
1.4	Software Operation	8
2	HARDWARE ASPECTS	9
2.1	Optical Diagram of the LSM 710 and LSM 780 Systems (Schematic).....	9
2.2	Performance and Features of the LSM 710 and LSM 780 Systems	10
2.3	Microscope Equipment of the LSM 710 and LSM 780 Systems.....	11
2.4	Computer Hardware and Software	13
3	STARTUP AND SHUTDOWN OF THE SYSTEM	14
3.1	Startup of the System	14
3.1.1	Handling of the Argon Laser.....	15
3.1.2	Starting ZEN	17
3.2	Shutdown Procedure	18
3.2.1	Exiting ZEN Software	18
3.2.2	Switching System Power Off.....	18
4	INTRODUCTION TO THE SOFTWARE APPLICATION LAYOUT	19
4.1	Overview on the Screen Layout.....	19
4.2	Introduction to ZEN.....	20
4.3	Function Elements	23
4.4	Application Bar	25
4.5	Menu Bar.....	25
4.5.1	File	27

4.5.2	Maintain	28
4.5.2.1	Set Spline	28
4.5.2.2	Camera	29
4.5.2.3	Hardware Administrator	29
4.5.2.4	Test Grid	29
4.5.3	Help – About	30
4.6	Main Toolbar	31
4.7	Status Bar	33
4.8	Left Tool Area	34
4.8.1	Tool Groups and Tools	36
4.8.2	Context Menu of the Left Tool Area	37
4.9	Center Screen Area	38
4.9.1	Overview of the Center Screen Area	38
4.9.2	Context Menu of the Center Screen Area	40
4.10	Right Tool Area	41
5	LEFT TOOL AREA AND HARDWARE CONTROL TOOLS	43
5.1	Ocular Tab	43
5.1.1	Basic Controls, Ocular Tool	43
5.1.1.1	Controls for Axio Imager.Z2	44
5.1.1.2	Controls for Axio Observer.Z1	48
5.1.1.3	Controls for Axio Examiner	51
5.1.1.4	Controls for the Axio Scope with Motorized Z-drive	51
5.1.2	Ocular Tool – Incubator Control	51
5.2	Acquisition Tab	52
5.2.1	Action Buttons	52
5.2.2	Smart Setup	53
5.2.3	Tool Group Setup Manager: Laser Tool	55
5.2.4	Tool Group Setup Manager: Imaging Setup Tool	57
5.2.5	Tool Group Setup Manager: Light Path Tool	60
5.2.5.1	Activation/Deactivation of Channels	61
5.2.5.2	Reflector Turret	61
5.2.5.3	Stage / Focus	61
5.2.5.4	Setting of Laser Line and Laser Attenuation	62
5.2.5.5	Multiple Tracks Configuration	62
5.2.5.6	Ratio Imaging Configuration	63
5.2.5.7	Imaging in Lambda Mode	64
5.2.5.8	Online Fingerprinting Mode	65
5.2.5.9	Camera Mode	66
5.2.6	Tool Group Online Acquisition: Acquisition Mode Tool	67
5.2.6.1	Frame Mode for LSM	68
5.2.6.2	Frame Mode for Camera	76
5.2.6.3	Line Mode	77
5.2.6.4	Spot Mode	78
5.2.7	Tool Group Online Acquisition: Channels Tool	79

5.2.8	Ratio Channels	81
5.2.9	Tool Group Online Acquisition: Focus Tool	82
5.2.10	Tool Group Online Acquisition: Stage Tool	83
5.2.11	Tool Group Online Acquisition: Regions Tool	84
5.2.12	Tool Group Multidimensional Acquisition: Z-Stack	86
5.2.12.1	How to Proceed Setting a Z-Stack Using First/Last Mode	86
5.2.12.2	How to Proceed Setting a Z-Stack Using Center Mode	87
5.2.12.3	How to Proceed Setting a Z-Stack Using Piezo Mode	88
5.2.12.4	Optimize Sectioning and Stack	89
5.2.12.5	Correction	90
5.2.13	Tool Group Multidimensional Acquisition: Bleaching	91
5.2.14	Tool Group Multidimensional Acquisition: Time Series	93
5.2.15	Tool Group Multidimensional Acquisition: Tile Scan	95
5.2.16	Tool Group Multidimensional Acquisition: Information On Experiment	97
5.2.17	Tool Group Multidimensional Acquisition: Positions	97
5.2.18	Tool Group Multidimensional Acquisition: Auto Save	99
5.2.19	Image Optimization	100
5.2.19.1	Requirements	100
5.2.19.2	Defining the Scan Parameters	102
5.2.19.3	Defining the Detection Parameters	103
5.2.19.4	How to Optimize Image Quality	103
5.3	Processing Tab	105
5.3.1	General Structure of the Processing Tab	105
5.3.2	Maximum Intensity Projection	107
5.3.3	Image Calculator	108
5.3.4	Average	110
5.3.5	Filter	111
5.3.6	Correlation	113
5.3.7	Modify Series	114
5.3.8	ICS	115
5.3.8.1	Remove Structures	115
5.3.8.2	ICS Correlation	116
5.3.8.3	Map Filter	118
5.3.9	Linear Unmixing	119
5.3.10	Ion Concentration	124
5.3.10.1	Single Wavelength Dyes – Offline Calibration	126
5.3.10.2	Ratiometric Dyes	127
5.3.11	Stitch	130
5.3.12	Deconvolution	131
5.3.12.1	Methods	133
5.3.12.2	PSF Tab	134
5.3.13	Copy	135

5.3.14	Adjust	137
5.3.14.1	Burn in Brightness and Contrast	137
5.3.14.2	Interpolate Brightness and Contrast.....	137
5.3.14.3	Channel Shift.....	139
5.3.14.4	Shading Correction	140
5.4	Maintain Tab	141
5.4.1	Adjust Pinhole and Collimator	141
5.4.1.1	Pinholes Section Panel	142
5.4.1.2	Collimators Section Panel	143
5.4.1.3	How to Adjust the Pinhole	144
5.4.2	Objectives	147
5.4.2.1	Change Objective.....	147
5.4.2.2	Add Objective	148
5.4.2.3	Remove Objective	149
5.4.2.4	Edit Objective.....	149
5.4.2.5	Focus Speed.....	150
5.4.2.6	Parfocal Correction	150
5.4.3	LSM Options	151
6	CENTER SCREEN AREA / IMAGE CONTAINERS - DISPLAY AND IMAGE ANALYSIS.....	153
6.1	Structure and Functional Concept of the Center Screen Area and the Image Display Container.....	153
6.1.1	General Structure	153
6.1.2	Container Configuration with the Container Context Menu	157
6.2	2D View.....	158
6.2.1	Dimensions	158
6.2.2	Display	162
6.2.3	Player	162
6.2.4	Overlay	163
6.2.5	Preview View	167
6.3	Split View.....	168
6.4	Gallery View	169
6.5	Ortho View	170
6.5.1	Ortho - Select Function.....	171
6.5.2	Ortho - Distance Function.....	172
6.6	Cut View	173
6.7	2.5 D View.....	174
6.8	3D View (Image VisArtplus).....	176
6.8.1	Shadow Projection	178
6.8.2	Transparency Render Mode.....	181
6.8.3	Maximum Mode	182
6.8.4	Surface Render Mode.....	182
6.8.5	Mixed Render Mode.....	183

6.8.6	Clipping Planes.....	184
6.8.7	Flying Mode	188
6.8.8	3D Rendering Settings in <i>VisArtplus</i>	188
6.8.9	Series	190
6.8.10	Interactive Measurements.....	192
6.8.11	Settings	193
6.8.12	Options	194
6.8.13	3D View – Basic.....	195
6.9	Histogram View	196
6.10	Colocalization View.....	199
6.10.1	How a Scatter Diagram is Generated	201
6.10.2	Quantitative Colocalization Parameters Shown in the Data Table.....	202
6.10.3	Colocalization Coefficients	202
6.10.4	Overlap Coefficient, Overlap Coefficient after Manders	203
6.11	Profile View	203
6.12	Topography View.....	206
6.12.1	Control Block: Display	207
6.12.2	Control Block: 3D.....	210
6.12.3	Control Block: Measure	212
6.12.3.1	Profile Measurement	213
6.12.3.2	Z-histogram Measurement	215
6.12.3.3	Bearing Area Ratio Measurement	215
6.12.3.4	Roughness Measurement in 2D (Profile) and 3D	215
6.12.3.5	Volume Measurement in 3D.....	220
6.12.4	Control Block: 3D Measurement.....	221
6.12.5	Control Block: Series	221
6.13	Mean of ROI: Additional View Type for Time Series	222
6.14	Kinetic / FRAP View: Additional View Type for Time Series	226
6.15	Lambda Coded: Additional View Types for Lambda Mode	232
6.16	FRET View	234
6.16.1	Tools in the FRET View Options Control Block for Acceptor Photobleaching.....	235
6.16.2	Tools in the FRET View Options Control Block for Sensitized Emission	236
6.17	Unmixing View	239
6.17.1	Automatic Component Extraction	244
6.18	Raster Scanning Image Correlation Spectroscopy (RICS)	246
6.18.1	Access to RICS.....	247
6.18.2	Control of View Functionalities	247
6.18.3	Correlation Functionalities	248
6.18.4	Display Functionalities	251
6.18.5	Fitting Functionalities.....	258
6.18.6	Model Functionalities	261

6.19	Polarization Imaging	265
6.19.1	Light Path for Polarization Imaging	266
6.19.2	Determination of G-factor	267
6.19.3	Obtaining an Anisotropy Image	268
6.20	Information View	270
7	RIGHT TOOL AREA, DATA MANAGEMENT AND STORAGE	272
7.1	General.....	272
7.2	ZEN File Browser	273
7.2.1	Gallery View of the ZEN File Browser	274
7.2.2	Form View of the ZEN File Browser	277
7.2.3	Table View of the ZEN File Browser.....	278
7.3	Open Images.....	280
7.4	Opening of Files via the "Open" Command in the File Menu.....	283
7.5	Save	283
7.6	Export of Images	284
8	INDEX	285

1 Purpose

This section describes the operation of the Laser Scanning Microscope with the ZEN 2010 software.

When starting up and operating the microscope system, mind the operating instruction manuals for the Axio Imager.Z2, Axio Imager.M2, Axio Observer.Z1 and Axio Examiner microscopes:

- M70-2-0020 Axio Imager.Z2 / M2, Operating Manual
- B 40-0111 Axio Observer.Z1, Operating Manual
- M60-2-0003 Axio Examiner, Operating Manual
- M60-2-0007 Axio Scope.A1, Operating Manual

1.1 Software

The ZEN software is used to

- control the microscope, the scanning module, the laser module, and the image acquisition process
- display, edit and analyze the images

It is a special user interface (desktop) based on the network-capable graphic 32-bit / 64-bit Microsoft® WINDOWS VISTA operating system.

Portions© Copyright 2007, Microsoft Corporation. All rights reserved.

The installation of the software for the Laser Scanning Microscope and the basic settings of the equipment components are carried out by Carl Zeiss service staff. This job includes the creation of a customized software configuration in line with the specific hardware components of the customer's microscope system.

1.2 Convention for the Text in this Manual

All the originally used terms of the software interface, e.g.

- names of windows
- tool groups
- panels
- input boxes
- list / selection boxes
- check boxes
- menu items
- names of buttons and sliders
- keyboard keys

are displayed in **bold letters** to allow easier identification.

1.3 Backup

System backup

- A complete backup of the operating system and application software is available on the enclosed system image CD-ROM.

User files backup

The following user-generated files should be included in a backup procedure controlled and carried out on a regular basis by the user (keep directory structure):

- LSM Image files: *.lsm
- Exported images: *.* (*.Tiff, *.LSM-Tiff, *.BMP, ...)
- Palette files: ZEN\Palette*.lut
- Filter files: ZEN\Filter*.krm
- Pinhole setting files: ZEN\PH*.pos
- Log files: ZEN*.log
- User defined configuration .xml files: C:\Documents and Settings\Username\Application Data\Carl Zeiss\AIMApplication\

The following files generated during the system integration should also be included in a backup procedure:

- Parameter file for pinhole setting: ZEN*.set
- Parameter file after pinhole adjustment: ZEN*.adj
- Scanner files: ZEN\bin*.bin
- Microscope stand database: ZEN\database\system_configuration_*.mdb

1.4 Software Operation

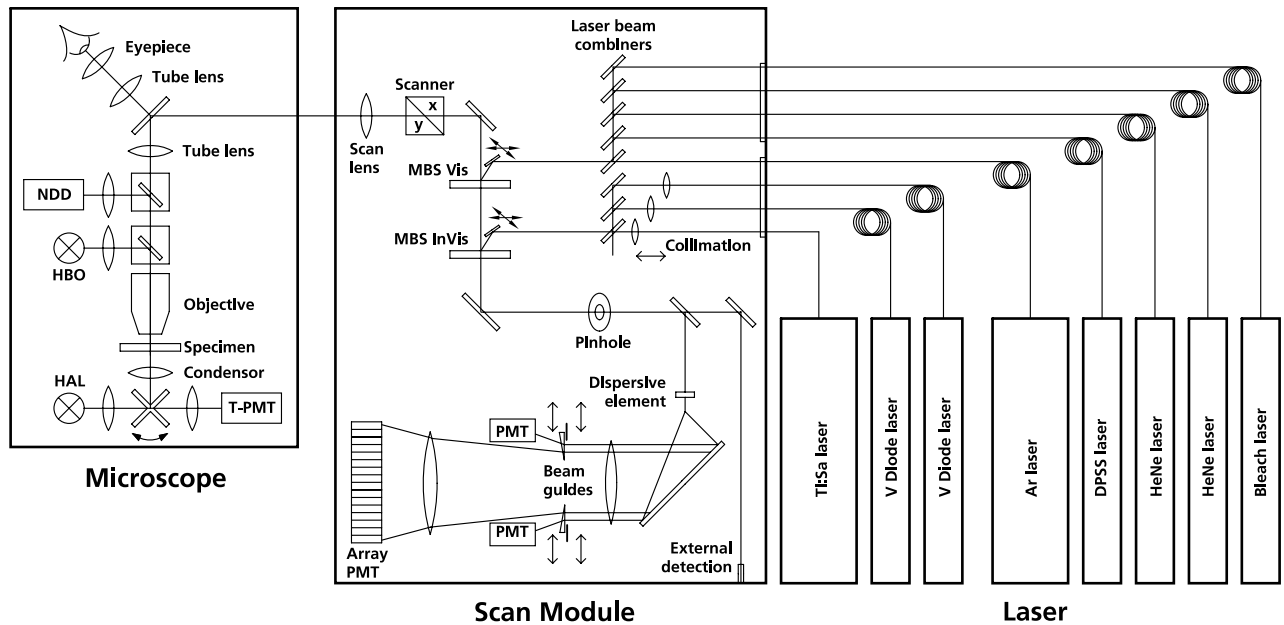
The ZEN software can be operated using the mouse, the PC keyboard, or both.

The operation of the mouse and the keyboard is identical to that of the Microsoft® WINDOWS VISTA operating system and is therefore not described in this manual.

If required, see the Microsoft manual or online help for relevant information.

2 Hardware Aspects

2.1 Optical Diagram of the LSM 710 and LSM 780 Systems (Schematic)



- HAL Halogen Lamp
- HBO Mercury Vapor Short-Arc Lamp
- MBS Main Beam Splitter
- NDD Non-Descanned Detector
- PMT Photomultiplier
- T-PMT Transmission-Photomultiplier

Fig. 1 Optical path, schematic (34-channel configuration)

The diagram above is a schematic representation of the LSM system.

Laser light is focused onto the specimen through an objective in a diffraction-limited mode. Light emitted at the focal plane and at planes below and above it is directed via an XY scanner onto a main beam splitter (MBS), which separates the emissions from the excitation light. The fluorescence signals are separated from each other by the beam guides and directed to individual photomultipliers.

2.2 Performance and Features of the LSM 710 and LSM 780 Systems

Optical and Mechanical Aspects

The highly integrated system design makes for the shortest possible optical paths, top-grade optical precision and high stability. The compact scanning module can be fitted to an inverted (Axio Observer.Z1 RP or SP) or upright (Axio Imager.Z2, Axio Imager.M2 or Axio Examiner) microscope in less than three minutes. On the Axio Observer.Z1, the scanning module may be mounted either to the base port directly below the microscope or to the side port.

The spectral range available extends from the UV to the IR region.

For the VIS (visible-light) Laser Module, the user can select from up to six lasers with wavelengths of 633, 594, 561, 543, 514, 488, 477 and 458 nm and the tunable laser "In Tune" covering the whole range from 488 to 640 nm. The V Laser Module provides wavelengths of 405 and 440 nm (440 nm laser not in combination with In Tune). A Ti:Sa Laser provides pulsed laser light from 680 to 1064 nm for Multiphoton imaging (NLO). Coupling of the laser light (except the Multiphoton laser) is through polarization-preserving single-mode optical fibers. One variable beam collimator each for the V or NLO and visible ranges provides optimum adaptation of the respective laser wavelength to the objective used and, thus, optimum correction for Z aberrations.

Acousto-optical tunable filters (AOTF) adjust the necessary brightness for up to 8 laser lines within microseconds.

A monitor diode is available for service and maintenance tasks and to reuse the laser power of earlier experiments (function depending on software implementation).

The 2,3 or 34 internal image acquisition channels (in PMT or GaAsP technology), usable for fluorescence, and an additional transmitted-light channel are ideal for the investigation of multiple fluorescence specimens. The diameter of the pinhole and the XY positions can be optimized, and the desired emission can be selected. This adjustment also includes positioning along Z. For the simultaneous registration of multiple fluorescence signals, identical optical sections can be obtained in each confocal channel.

The microscope's transmitted-light channel is equipped with a photomultiplier, too. It is therefore possible to superimpose a multiple fluorescence image on a brightfield, differential interference or phase contrast image.

The high-NA C-APOCHROMAT objectives especially developed for the LSM reach the physical limit in resolving power, and can be used throughout the 380...900 nm spectral range with the same high quality, producing brilliant images.

A two-mirror scanner system, controlled by real time electronics, offers several advantages. The large deflection angle of the scanning mirrors allows a wide area to be scanned. With a 1.25× objective, the object area scanned is 11 × 11 mm².

The scanning field size can be freely selected between 4 × 1 and 6144 × 6144 pixels.

It is possible to rotate the XY scanning field through 360° and carry out XY scans without having to rotate the specimen itself under laser radiation load.

Selection of the specimen detail of interest for zooming is fast and convenient, and the zoomed image is automatically centered. This saves the job of placing the specimen into the center with the microscope stage.

Using a bi-directional scanning facility will double the scanning rate to approx. 8 frames/sec (at 512 × 512 pixels); if two different laser wavelengths are used for the two scanning directions (wavelength 1 for left-to-right, and wavelength 2 for right-to-left scanning), two fluorescent dyes can be viewed and documented in a quasi-simultaneous mode. This will prevent cross talk between detection channels.

2.3 Microscope Equipment of the LSM 710 and LSM 780 Systems

The LSM 710 and LSM 780 systems are equipped either with the inverted Axio Observer.Z1 BP or SP microscope or with the upright Axio Imager.Z2, Axio Imager.M2 or Axio Examiner microscopes.

Only the differences from the delivered operating manual "Axio Observer.Z1" will be explained here.

(1) Stand

- The motorized objective nosepiece 5× H DIC is firmly fixed to the stand, where no operating elements can be found for the nosepiece. Operation will be performed via LSM software control. The "Restriction of the nosepiece height to protect the objectives during motorized objective change" is inactivated. The nosepiece will be moved down automatically before each motorized objective change.
- The reflector mount is motorized and provided with the Axio Observer.Z1 reflector turret. The reflector turret has six positions: One transmitting light position, which is identical to the LSM position, and five further positions for fluorescence filter sets (reflector modules). If you want to use more than five conventional fluorescence filter sets, it is advisable to use a further reflector turret. When changing the reflector turret position you must make sure that the turret will click into position, since otherwise the image area will be cut.
- The stand has a motorized focusing drive (fine coarse). Sensitivity of the focusing drive is adjusted to the delivered objectives by the manufacturer. If you want to use other objectives, sensitivity and parfocality can be adjusted via the Axioset program.
- The stand features an integrated power supply for the internal motors and stand electronics. The power supply can be switched at the external power supply unit for the microscope. External power supply units will be used for the mercury vapor short arc lamp or the X-Cite 120 fiber coupled lamp.
- The analyzer slider for conventional DIC methods will be operated from the right side and is located just below the nosepiece.
- When the rod is pushed in, the analyzer is located in the beam path. In the LSM-mode, the analyzer must **not** be located in the beam path, and the analyzer rod must be pulled out.

(2) Specimen stages and fine focus drives

- Mechanical stage
The stage with coaxial drive must be mounted on the right side of the stand.
- Scanning stage
- Piezo objective focus drive

(3) Transmitted-light illumination

- The illuminator support contains a security circuit which activates a shutter preventing laser light from reaching the stand when the support is moved to the back. A complementary shutter built in the stand prevents laser light from reaching the eyepieces during the scanning mode.
- The illuminator support is equipped with a rotary polarizer. The Axio Observer.Z1 description contains the adjustment for the DIC mode during conventional observation.
- For scanning in the transmitted-light DIC mode, the polarizer in the transmitted light support works like an analyzer and must be adjusted in such a manner that direct laser light will be blocked.
- The conventional analyzer slider in the stand must not be located in the beam path because the laser light is already polarized.
- A fully motorized, LSM software-controlled switching mirror is mounted on the illuminator support. Alternatively, the light is directed to the LSM transmitted-light detector or enables conventional transmitted-light observation.
- The focusing screen for conventional transmitted-light is located in a support in front of the halogen lamp housing.
- Further information on the halogen lamp and the condensers is provided in the Axio Observer.Z1 operating manual.

(4) Reflected light fluorescence

With the exception of the reflector slider, all the Axio Observer.Z1 fluorescence accessories can be used. Further information is provided in the Axio Observer.Z1 operation manual.

(5) Imaging optics

Optovar sliders cannot be used.

The analyzer for the conventional DIC mode will be operated from the right side and is located just below the nosepiece.

Use of sliders with auxiliary objects (473704/14-0000-000) is not possible.

(6) Photo equipment

The stand does not feature an integrated SLR-port, but microscope cameras as described in the Axio Observer.Z1 and LSM 710 and LSM 780 systems operation manual can be used.

(7) Camera adaptation

The Camera port at the side and the tubes can be used as described in the Axio Observer.Z1 operation manual.

The Camera interface side port can be used with camera adapters 60 N or LSM adapters.

2.4 Computer Hardware and Software

The LSM 710 and LSM 780 systems are controlled via a standard high-end Xeon PC. Linking to the electronic control system is made via Gigabit Ethernet interface. The PC comes with WINDOWS VISTA operating system.

The instrument is fully motorized, permitting fast change-over between methods as well as automatic operation. Parameters once set or complex examination sequences once established can be saved and reproduced; therefore, complete application programs can be loaded and performed by pushbutton control.

Conversion of the light signals into a digital image is effected by 16-bit A/D converters, each of which can generate 65536 brightness levels.

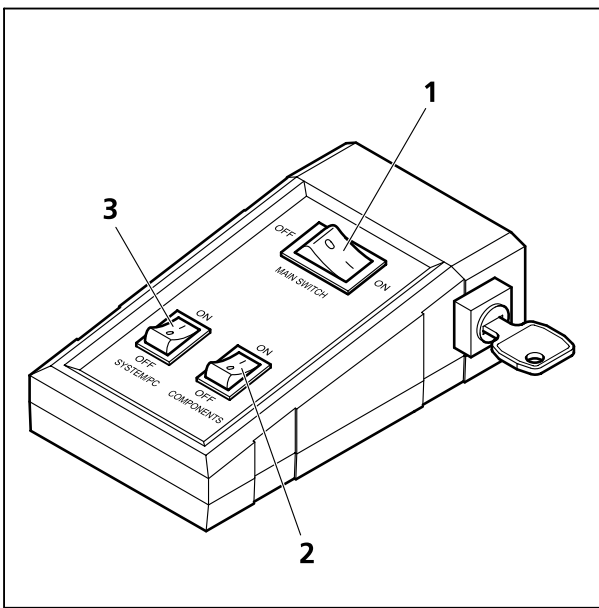
The software provides an enormously wide range of image processing functions, including all standard 2D/3D (stereo, projection) functions identical to sophisticated 3D reconstruction capabilities (surface and alpha rendering), digital processing of voxels and 3D measurement functions (surface areas, volumes).

3 Startup and Shutdown of the System

3.1 Startup of the System

The LSM system is equipped with a main power switch and two further switches labeled **System/PC** and **Components** that are located at the front of the System Electronic Rack. The main switch has to be set to **ON** to be able to switch the system on and off using the **System/PC** and **Components** switches. The main switch can be used to switch off the complete system with one switch only. The electronics to run the computer and the microscope are switched on with the **System/PC** switch. The laser module and the scan head are switched on with the **Components** switch. These switches are also accessible via the power remote witch (Fig. 2).

Refer to the operating manual and CHAPTER 7 ANNEX of the printed manual for handling of any Titanium-Sapphire-Laser used for Multiphoton (NLO) Microscopy.



- 1 Main switch ON/OFF
- 2 COMPONENTS switch ON/OFF
- 3 SYSTEM PC switch ON/OFF

Fig. 2 Power remote switch

- To start the system switch the main switch (Fig. 2/1) to **ON**.
- When set to **ON** the power remote switch labeled **System/PC** (Fig. 2/3) provides power to the computer. This allows using the computer and ZEN software offline.



The drives for floppy discs and CD/DVD of the computer must not contain any data storage item.

- To switch on the system completely put the **Components** switch (Fig. 2/2) also to **ON**. Now the complete system is ready to be initialized with the LSM Software.
- After switching on the computer type in the user name and password to log on to the computer.
- After entries, confirm by clicking the **OK** button or **Enter**.
- The WINDOWS VISTA operating system desktop appears on the screen, showing a number of icons.



Maintenance Tool icon

With a calibration objective and correct system configuration, the maintenance tool allows convenient self adjustment of the LSM 710 and LSM 780 systems system. The optical beampath, relative pinhole position and scanner adjustment can be set and checked automatically on the LSM 710.



Stand Select icon

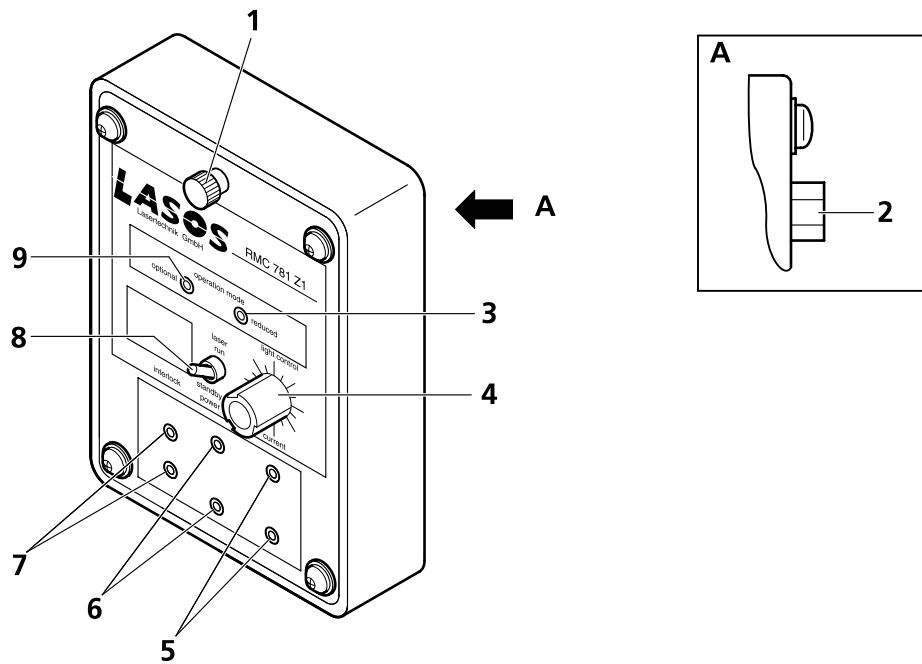
The **Stand Select** tool permits a new or updated database to be assigned to the LSM software program. This function should preferably be performed by authorized service personnel. See printed manual CHAPTER 6 TOOLS, ADDITIONAL SOFTWARE.



ZEN icon




Start ZEN software for operating the LSM laser scanning microscope.

3.1.1 Handling of the Argon Laser



- | | | | |
|---|--|---|--|
| 1 | Holding-down bolt | 6 | Power measuring connection |
| 2 | Connection to the main power supply unit | 7 | Connection for external interlock loop |
| 3 | Red LED (output power too high - strong reduction of lifetime) | 8 | Switch LASER RUN/STANDBY |
| 4 | Light control potentiometer (laser power) | 9 | Green LED (Laser power stabilized; optimum power range regarding lifetime) |
| 5 | Current measuring connection | | |

Fig. 3 AR laser control

-
- First turn the key switch at the power supply of the argon laser from Standby to On. The laser is then held in idle mode for about 5 minutes independent of the run-idle-switch.
 - Flip the run-idle-switch from IDLE to RUN (run-idle-switch button (Fig. 3/8) up).
 - After switching to RUN mode the laser power increases up to full power within 50 s (provided the 5 minutes idle time at start up are already over). The time it takes to get to the full power mode is also dependent on the setting of the potentiometer, lower power levels require less time for ramp up.
 - The green LED lights up if the set power is stabilized and the laser is ready to use (Fig. 3/9).
 - The tube current can be set with the light control potentiometer (Fig. 3/4). The adjustment range is from standby (left stop) to 7 A (green LED (Fig. 3/9)); tube currents greater 7 A will show a red LED (Fig. 3/3).
 - Warm up time after cold start to keep the specification for long-term stability is around 1 h.
-  The red LED indicates the power range which is critical for the lifetime of the laser. An operation in this power range is possible for a brief period, but not permanently.
-  Caution: Even in idle mode laser radiation is emitted.
- The 514 nm laser line becomes available at a tube current of 5 A. It is recommended to use this line at 6 A. Tube currents higher than 6 A will decrease the lifetime (red LED)!
 - The tube current can be monitored via the PIN 4 (Fig. 3/5) with a voltmeter. The output can be measured in mV/A; means 6 A will be shown as 0.6 V.
 - If the laser is not active over a longer time (e.g. 1 h), it should be set to standby. This protects the laser and increases the lifetime. It is better, to have the laser for a longer time in standby mode, than to switch it on and off several times per day.
-  The specified lifetime applies for a nominal power of 25 mW (or 40 mW) for all lines, with an operating regime of < 12 h/day. The required tube current might increase over time.

3.1.2 Starting ZEN

The ZEN software is started by double clicking the ZEN icon. The login panel (Fig. 4/a) appears on top of the ZEN Main Application window. The software can be operated in three different modes.

- Choosing **Start System** initializes the whole microscope system and activates the entire software package (image recording and analysis).
- The **Image Processing** mode ignores the hardware and activates only data handling and image processing functionality to analyze stored images.
- The **Offline/Demo** mode reads the active hardware database and simulates the respective hardware. This button is only available after opening the boot status display by clicking the little arrow left of the text "Boot Status" (Fig. 4/b).

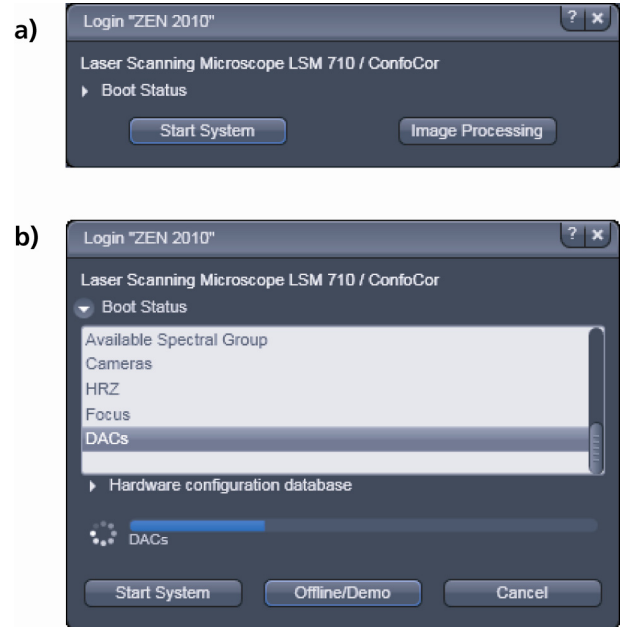


Fig. 4 Starting the ZEN software

3.2 Shutdown Procedure



Never shut down the computer by its main switch while the ZEN software is still active, or else you will lose the currently set operating parameters and the images just scanned.



In the **Maintain** tab / **LSM Options** dialog window, activate **Laser off** on **Exit** in the **Shutdown** tab (section **LSM Options**). The lasers will then automatically be switched off when you exit the LSM program.

3.2.1 Exiting ZEN Software

- Make sure you have saved all your image data.
- Switch off all the lasers which might still be running.
- Close the ZEN software window. This terminates the ZEN software.
- Shut down WINDOWS VISTA
- About 20 seconds after WINDOWS VISTA is shut down your computer turns off.

3.2.2 Switching System Power Off



Please bear in mind that a cooling phase of at least 5 minutes is required between switching off of the lasers and switching off of the entire system via the power remote switch or the Power Supply switch.



5 minutes after computer shutdown set the power remote switches **System/PC** and **Components** or the **Main** switch on the System Electronic Rack to position **OFF**. This puts your LSM 710 / LSM 780 microscope system, including the computer, off power.

4 Introduction to the Software Application Layout

4.1 Overview on the Screen Layout

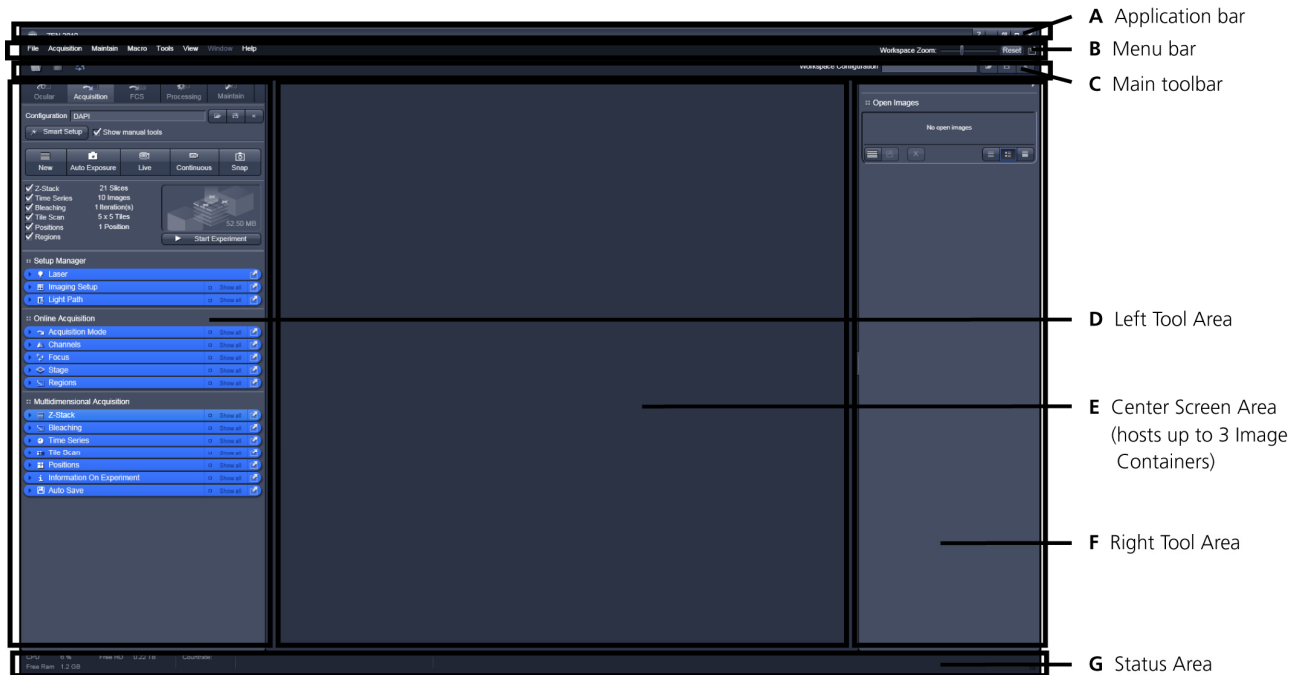
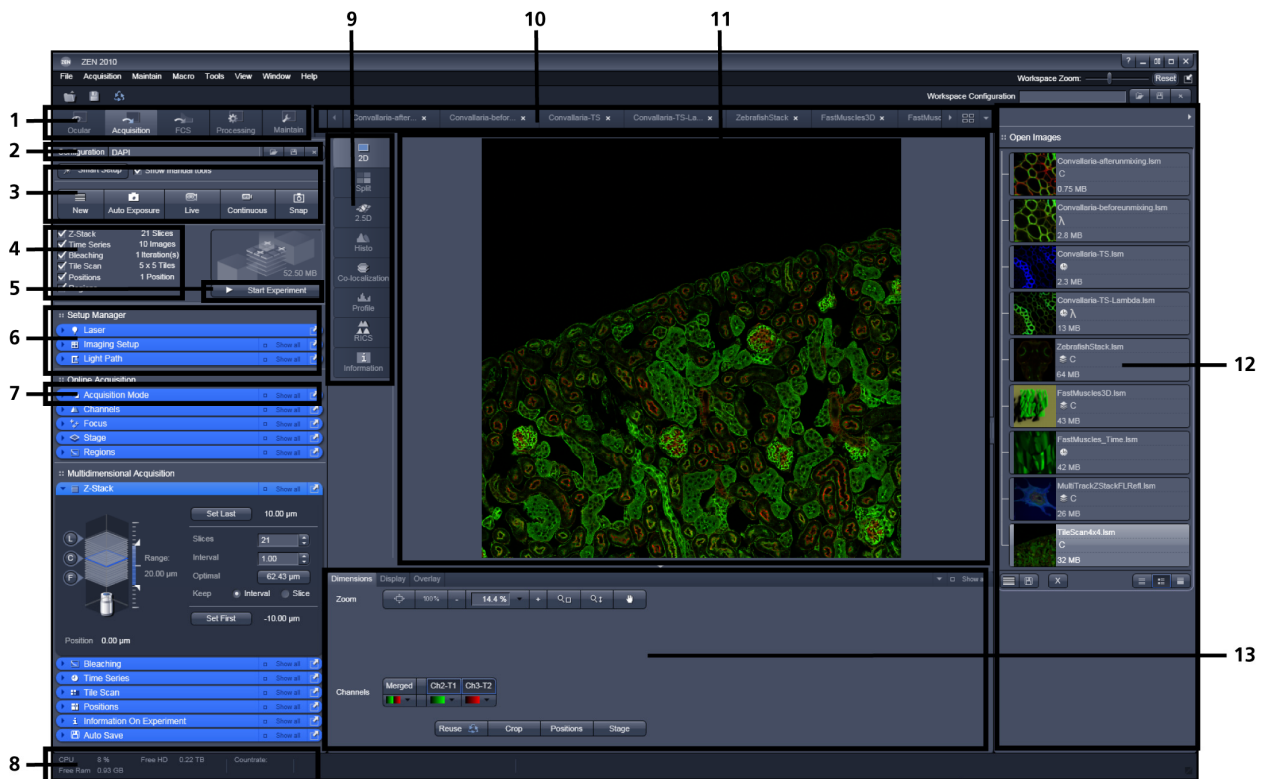


Fig. 5 ZEN Main Application window after Startup with empty image container



- | | | | | |
|------------------|--|--------------|-----------------------|------------------|
| 1 Main tool tabs | 4 Multidimensional tools selection panel | 7 Tool | 10 Image tabs | 13 View controls |
| 2 Configurations | 5 Starting multidimensional experiments | 8 Status bar | 11 Displayed image | |
| 3 Action buttons | 6 Tool group | 9 View tabs | 12 File handling area | |

Fig. 6 ZEN Main Application window after Startup with several images loaded

4.2 Introduction to ZEN

ZEN - Efficient Navigation - is the new software for the LSM Family from Carl Zeiss. With the launch of this software in 2007 Carl Zeiss sets new standards in application-friendly software for Laser Scanning Microscopy.

The ZEN Interface is clearly structured and follows the typical workflow of the experiments performed with confocal microscopy systems:

On the **Left Tool Area** (Fig. 5/D) the user finds the tools for image acquisition, image processing and system maintenance, easily accessible via 4 **Main** tabs (Fig. 6/1). All functions needed to control the microscope can be found on the **Ocular** tab, to acquire images use the **Acquisition** tools (Fig. 6/3 and 4). Arranged from top to bottom they follow the logic of the experimental workflow. The area for viewing and interacting with images is centered in the middle of the **Main Application** window: the **Center Screen Area**. Each displayed image can be displayed and/or analyzed with many view options available through "view tabs" which can be found on the left side of the image. According to the chosen view tab, the required view controls appear in View control blocks below each image. File management and data handling tools are found in the **Right Tool Area** (see Fig. 5 and Fig. 6).

Color and brightness of the interface have been carefully adjusted to the typical light conditions of the imaging laboratory, guaranteeing optimal display contrast and minimal stray light for high-sensitivity detection experiments. The **ZEN** software is optimized for a 30" TFT monitor but can also be used with dual-20" TFT setups.

A focus in the development of **ZEN** was to fulfill the needs of both basic users and microscopy specialists. Both types of users will appreciate the set of intuitive tools designed to make the use of a confocal microscope from Carl Zeiss easy and fast:

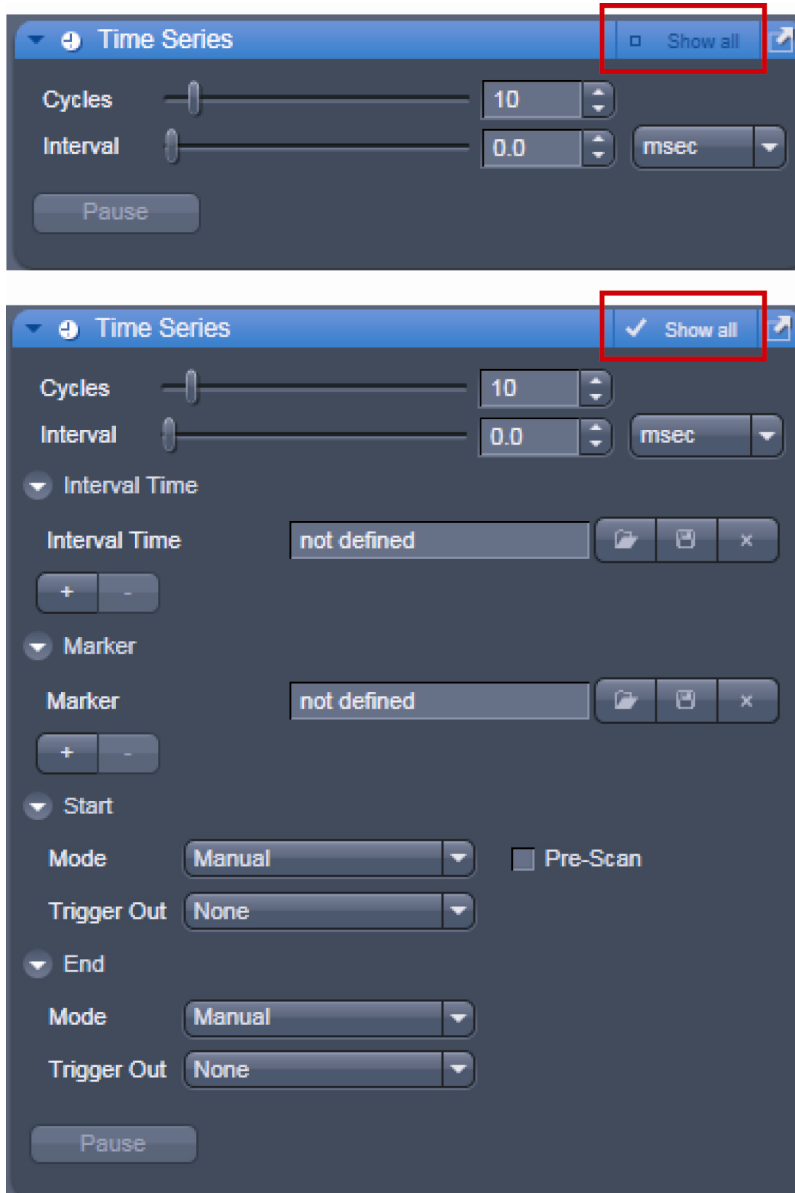
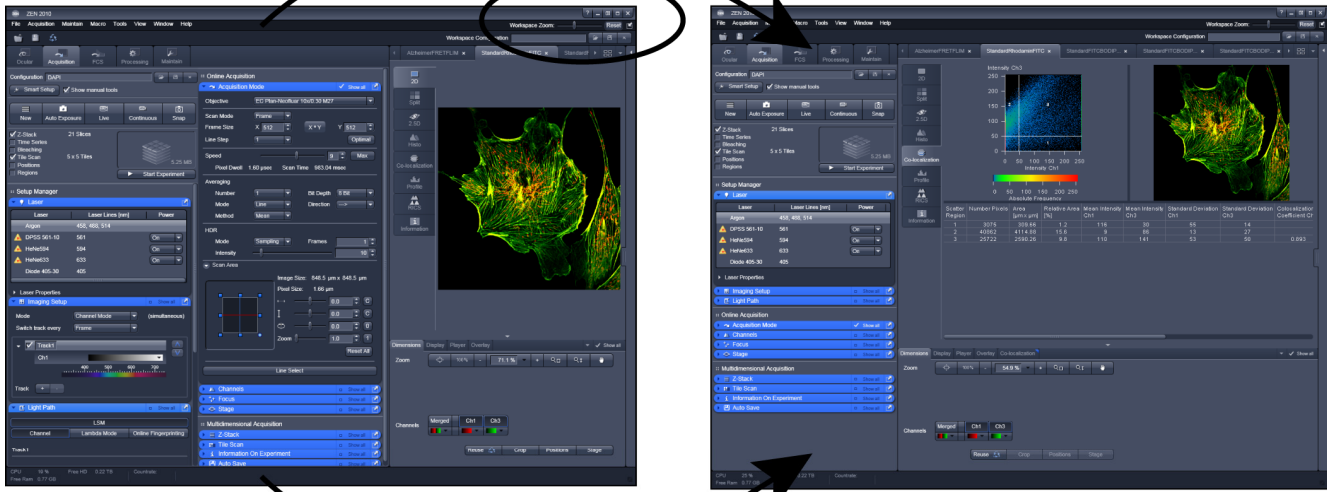


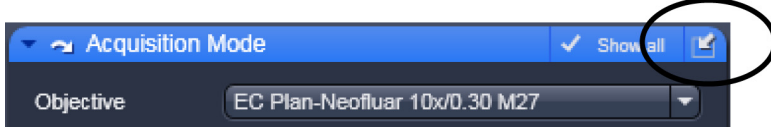
Fig. 7 Show all mode

The **Show all** concept ensures that tool panels are never more complex than needed. In the basic mode of the tools **Show all** is deactivated and the tools show only the most relevant functions, covering approximately 80 % of the users application. For each tool, the user can activate **Show all** to display and use additional functionality (Fig. 7).

Workspace zoom



Variable number of columns




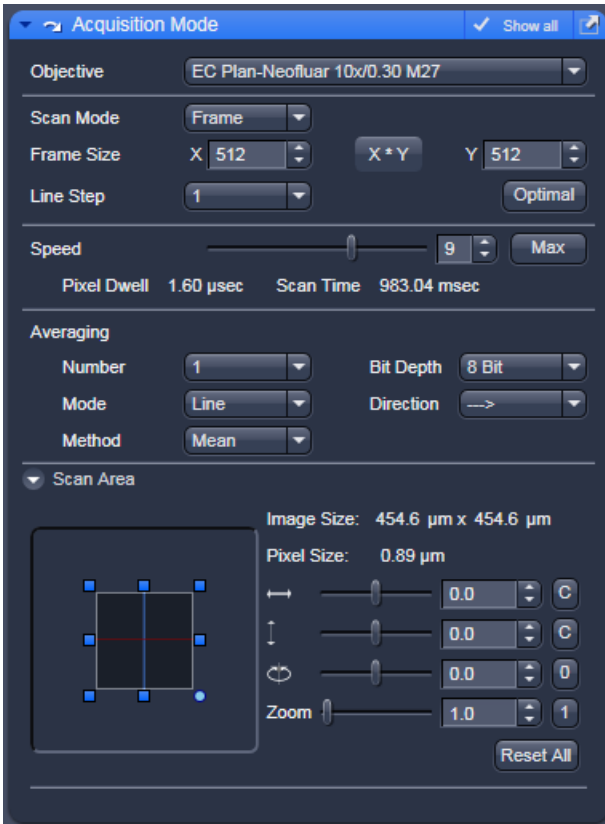
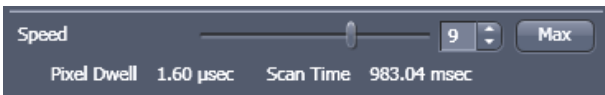
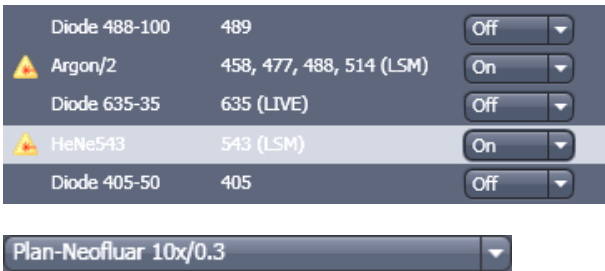

Undock tool


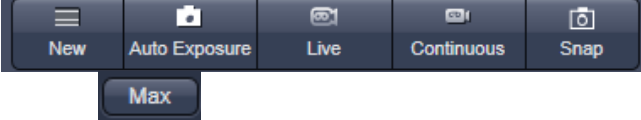
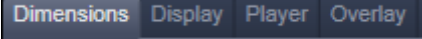

Fig. 8 ZEN window Layout configuration

More features of **ZEN** include:

- The user can add more columns to the **Left Tool Area** or detach individual tools to position them anywhere on the monitor. To add a column, drag a **tool group** by the title bar (e.g. "Online Acquisition") to the right and a new tool column automatically opens. To detach a tool, click on the little icon on the very right end of the blue tool header bar or drag it by this blue header bar to where you want it (Fig. 8).
- Another unique feature in Imaging software is the scalable ZEN interface. This **Workspace Zoom** allows adjustment of the **ZEN** window size and fonts to the situational needs or your personal preferences (Fig. 8).
- Setting up conventional confocal software for a specific experiment can take a long time and is often tedious to repeat. With ZEN these adjustments have to be done only once – and may be restored with just two clicks of the mouse. For each type of experiment one can now set-up and save the suitable **Workspace Layout**. These configurations can also be shared between users.
- For most controls, buttons and sliders, a **tool tip** is available. When the mouse pointer is kept over the button, a small pop up-window will display which function is covered by this tool/button.





4.3 Function Elements

Function element	Description / Explanation
	<p>Tool group</p>
	<p>Tool (closed) or tool window (opened)</p>
	<p>Panel (e.g.: Speed panel)</p> <ul style="list-style-type: none"> - Field with a subset of tools of a tool window
	<p>List box or selection box</p> <ul style="list-style-type: none"> - Selection of one of the displayed options via a mouse click. The selected option is highlighted. - Open the box by clicking on the arrow button.
	<p>Input box with arrows ("spin box")</p> <ul style="list-style-type: none"> - Input of text or numeric values via the keyboard or using the arrows.

	<p>Slider with input ("spin") box and arrows</p> <ul style="list-style-type: none"> - Setting of numbers in the relevant input box by moving the slider or clicking on the arrow buttons or clicking on the slider and moving via the arrow keys of the keyboard. Press the Shift or Ctrl key while clicking on the arrow button to change the numeric values in coarse or fine steps.
	<p>Button</p> <ul style="list-style-type: none"> - Selection / performance of a function via mouse click.
	<p>Tab</p> <ul style="list-style-type: none"> - Selection of functions of a tab via mouse click (e.g.: Track1 or Track2 tab).
	<p>Load – Save - Delete</p> <ul style="list-style-type: none"> - Buttons to load, save or delete a configuration, overlay set, track setting etc.

4.4 Application Bar

The application bar includes the following control elements of the ZEN software application window:

-  minimizes the application window
-  switches between one-screen mode and two-screen mode of the window
-  switches between maximized-window mode and compressed-window mode
-  closes the window

4.5 Menu Bar

The menu bar contains the menu items and the controls for the **Workspace Zoom**, including the **Reset** button for the **Workspace Zoom** and the button to re-dock all free floating tools to the **Left Tool Area**.



Fig. 9 Menu bar, left side

The menu functions are shown in the following menu overview (see next page).

Workspace Zoom

Moving the slider to left or right, changes the display size of the Left/Right Tool Area and the Center Screen Area.

Clicking the **Reset** button, sets the standard zoom factor for all areas.





Fig. 10 Menu bar, right side

Clicking on  moves all undocked tools back to the **Left Tool Area** (see also section **Tool Groups and Tools**).

Menu overview

File	Acquisition	Maintain	Macro	Tools	View	Window
New Acquisition Document Opens a new and empty image document	New Acquisition Document Opens a new and empty image document	Set Spline Opens the dialog for setting the spline parameters	Macro Opens the Macro Control window for creating, loading or handling macros	VSTA IDE Future control of non-VBA macros, currently inactive	Text View Displays the image tabs with text only	Close Closes the active window
Open Opens an existing document in the active image container	Auto Exposure Starts the Find procedure. This balances Gain settings.	Camera Opens the Camera Color Adjustment tool	Visual Macro Editor Opens the Visual Macro Editor	VSTA Macros Future control of non-VBA macros, currently inactive	Small Thumbnail View Displays the image tabs with small thumbnails	Close all Closes all windows, a separate save dialog window will be displayed if images have not been saved
Save Saves the active document	Find Focus Starts the Autofocus. A Line / Z Scan is performed and the focus position is determined upon contrast values.	Hardware Administrator For service only			Large Thumbnail View Displays the image tabs with large thumbnails	
Save As Saves the selected document using various image formats	Scan Overview Image Opens the dialog to set the parameters for an overview scan and to start the procedure	Test Grid For service only			1 Container Sets ZEN to work only with one image container	Help Help Opens the ZEN help
Export Exports the currently active document using various file formats	Live Starts the fast scanning procedure, scans with lower resolution and higher speed.				2 Containers Sets ZEN to work with two image containers	About Opens a panel with information about the ZEN release
New File browser Opens a document containing a ZEN File Browser.	Continuous Scans an image continuously with the currently active scanning parameters.				3 Containers Sets ZEN to work with three image containers	
Login Opens the Login ZEN dialog to change the software operation mode.	Snap Scans one single image.				Automatically layout container The size of the containers is automatically adjusted depending on the screen space available	
Spectra Database Opens the spectra database	Start Experiment Starts a multidimensional experiment (Z, T, ...).				Shared view Controls Shares the view controls below the images between containers	
Exit Closes the ZEN Software	Stop Stops the scanning immediately				Separate view Controls Each container is displayed with a separate view control panel	
					"Show all" (global) Sets all windows, tools and control panels to "show all", all controls are always visible in all tools	

 For detailed information about the image acquisition functions see section **Acquisition Tab**.

 The functionalities of the **Macro** menu are described in CHAPTER 5: MACROS AND VISUAL BASIC of the printed manual.

4.5.1 File

- In the menu bar, click on **File**.
 - This displays the menu shown in Fig. 11.

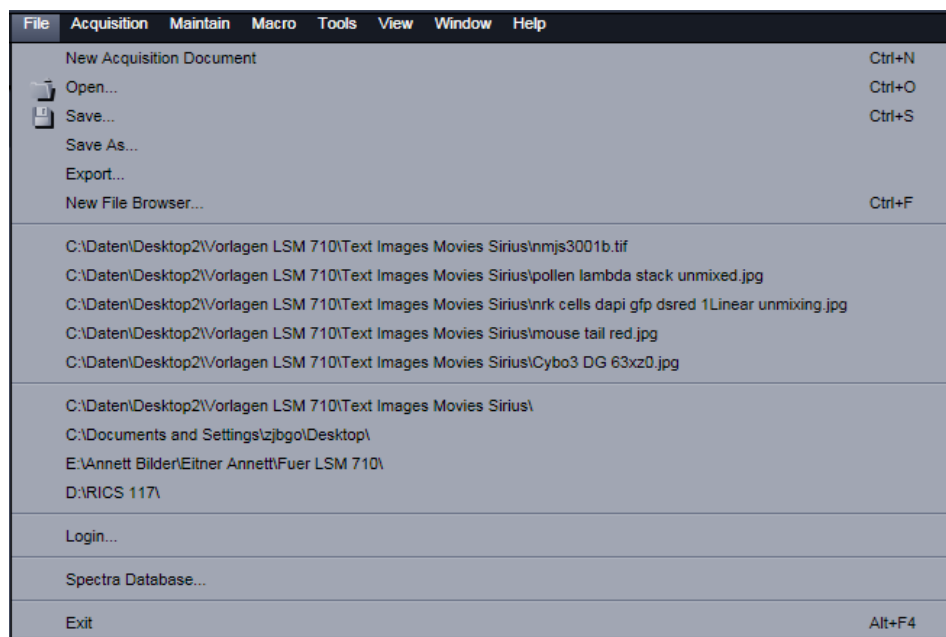


Fig. 11 File menu

The items in this list reflect the standard windows files menus with the following exceptions:

- **New File Browser** will open a ZEN File Browser in the currently active container (see section **ZEN File Browser**).
- In the second group of entries in the list, the five last accessed files are listed. Selecting a list entry will open the respective file.
- In the third group of entries, the four last accessed folders are listed. Selecting a list entry will open the ZEN File Browser and display the image files which are present in the folder.
- **Login** displays the **Login screen** and permits to change the operation mode of ZEN, e.g. from **Online** (with hardware started) to **Offline** (Image Processing or Demo mode), without quitting ZEN.
- **Spectra database** is starting the dialog used to handle previously recorded reference spectra.

 See also section **Right Tool Area, Data Management and Storage** for image file handling.



Fig. 12 Maintain list

4.5.2 Maintain

The **Maintain** menu from the **Menu** bar contains additional modules to check and guarantee the interference-free operation of all the software and hardware components of the LSM 710 and LSM 780 systems. In the **Menu** bar, click on **Maintain**. This opens the Maintain list (Fig. 12).

The maintain list is bipartite. On upper section lists user accessible tools, the lower section lists tools reserved for service personnel, they are password protected.

 See also section **Maintain Tab** for further information.

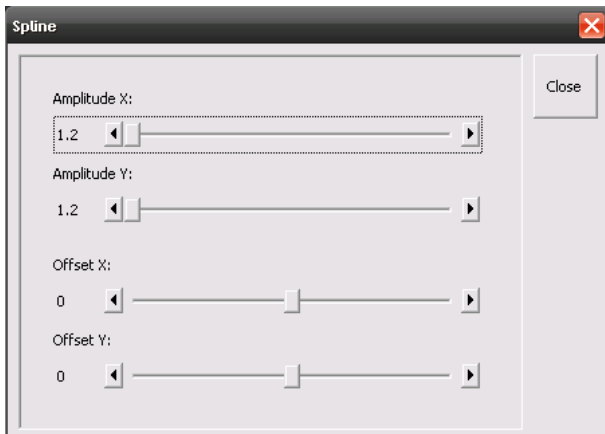


Fig. 13 Spline window

4.5.2.1 Set Spline

This function permits calibration of the Scanner position signals. This is required for the use of spline curves in the **Line** scanning mode.

- Click on **Set Spline** in the **Maintain** list.
 - The **Spline** window appears on the screen (see Fig. 13).
- You can set the required **Amplitude X**, **Amplitude Y**, **Offset X** and **Offset Y** values by using the sliders.
- Click the **Close** button to leave the window.

4.5.2.2 Camera

This function allows the user to adjust the white balance and color balance of a connected camera.

- Click on **Camera** in the **Maintain** list.
 - The **Camera Color Adjustment** window appears on the screen (see Fig. 14).

Clicking the **Pic** button allows to set the white balance using the mouse cursor in the camera image. The **Set** button will become active. Press **set** to store new settings, press **Reset** to return to the old settings.

Use the arrow buttons to adjust the color balance of the camera.

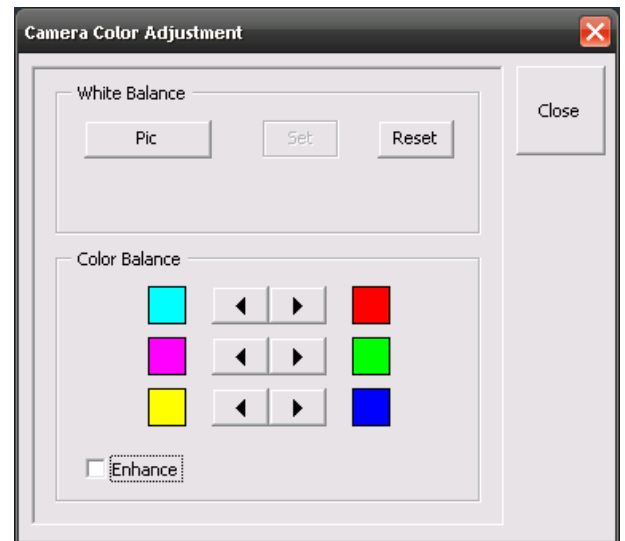


Fig. 14 Camera Color Adjustment window

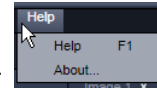
4.5.2.3 Hardware Administrator

The **Hardware Administrator** function is for servicing purposes and may only be used by authorized service personnel. Its access is therefore password-protected.

4.5.2.4 Test Grid

The **TestGrid** function is for servicing purposes only and may only be performed by authorized personnel. Its access is therefore password-protected.

4.5.3 Help – About



The **About** window can be accessed via the Help item in the menu bar clicking **About** opens the following dialog:

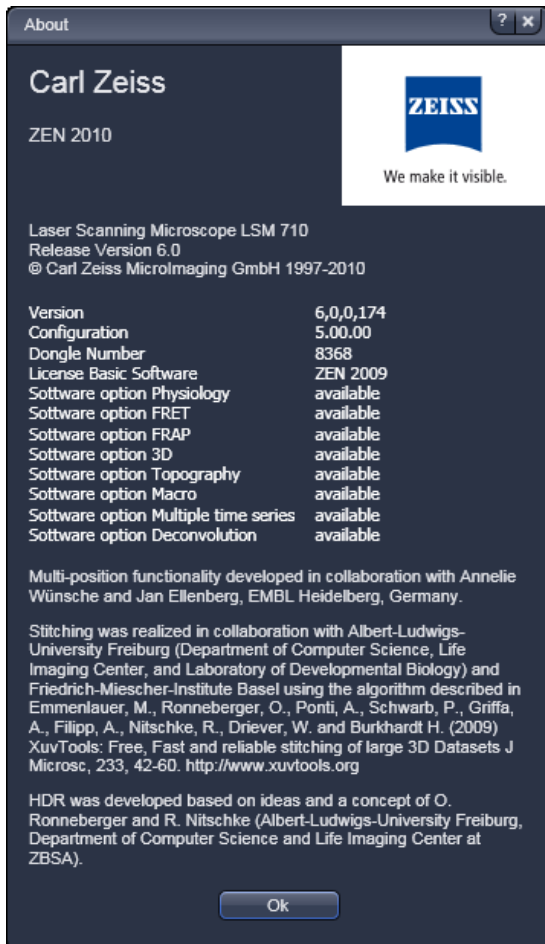
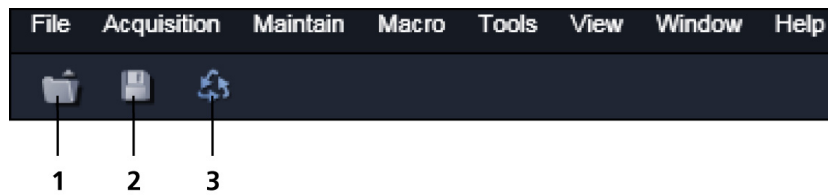


Fig. 15 About window

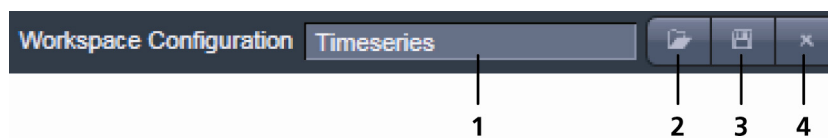
The panel hosts important information about the software version number, the license number and the available software modules.

4.6 Main Toolbar



- 1 Open image button
- 2 Save image button
- 3 Reuse button

Fig. 16 Main toolbar, left side



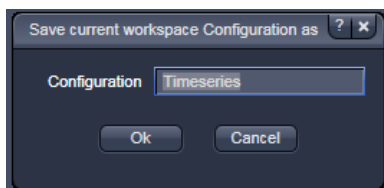
- 1 Workspace Configuration selection box
- 2 Load Workspace Configuration button
- 3 Save Workspace Configuration button
- 4 Delete Workspace Configuration button

Fig. 17 Main toolbar, right side

Workspace Configuration

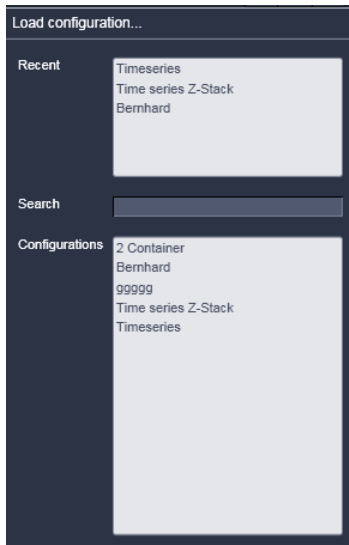
This function allows loading, saving or deleting a workspace configuration. These workspace configurations are saved settings that allow to restore a pre-defined layout of the whole ZEN application window, including status, size and position of tools and windows, workspace zoom, number of tool columns.

- To save a workspace configuration, click on the  button, the following dialog will appear:




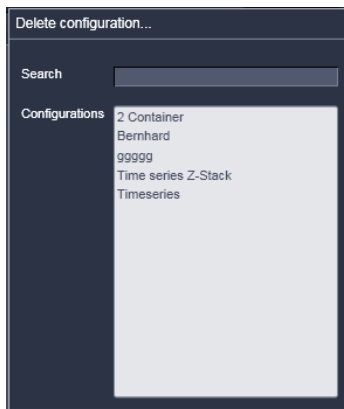
The name of the workspace configuration can be entered. Clicking **OK** saves the configuration.

- To load a workspace configuration, click on the  button. The following list box will appear:



Selecting on of the list entries will load the respective configuration.

- To delete a workspace configuration, click on the  button. The configuration to be deleted can be selected from a list.



4.7 Status Bar

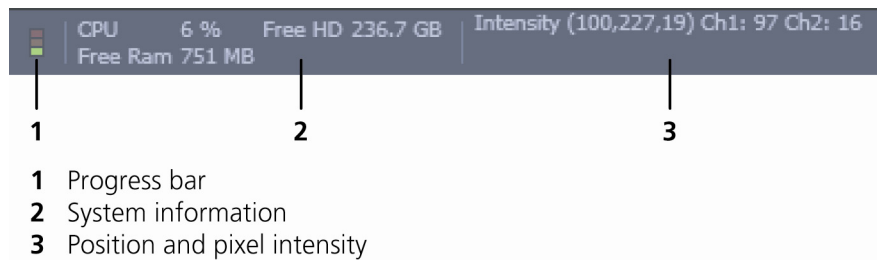


Fig. 18 Status bar

Progress bar

Shows an overview of all running processes. If only one process is running the details of this one are shown. If more than one process is running then the single process information will be shown in the gallery.



Fig. 19 Progress bar

System information

Shows information of the currently system tasks (state). The possible states are:

- CPU usage
- free hard disc capacity
- free RAM capacity

Position and pixel intensity

Shows the intensity values of the existing channels for the current X, Y and Z position of the mouse cursor in the image.



- 1 Main tool tabs
- 2 Imaging Configuration
- 3 Smart Setup
- 4 Action buttons
- 5 Selection panel for multidimensional acquisition
- 6 Tool groups

Fig. 20 Left tool area

4.8 Left Tool Area

Main Tool tabs

Switches between the **Ocular**, **Acquisition**, **Processing** and **Maintain** main tools to operate the included tool

Action buttons


Action buttons are only available for the **Acquisition Main** tool to control the image acquisition process.

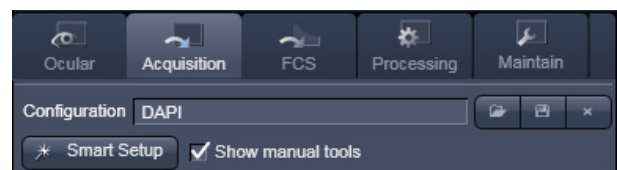
Tool groups

Groups special tools, e.g. **Setup Manager** or **Online Acquisition**.

Setup Manager

The tools of this tool group (Laser, Imaging Setup and light path) are only visible if the check box **Show manual tools** is checked. Those tools are necessary if the system should be operated in full manual mode. The use of the automated functions of ZEN like smart setup include the functions of those tools.

 The tools **Laser**, **Imaging Setup** and **Light Path** are not displayed by default in the software. They can be shown if the check box **Show manual tools** is checked.



Online Acquisition

Tools continuously needed for all acquisition

Multidimensional Acquisition:

Tools for all multidimensional imaging

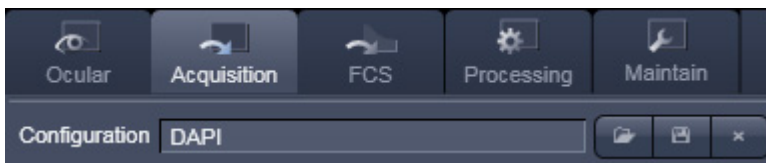
The tools of this tool group will only appear if selected in the selection panel below the start buttons. Once selected by the check box, the tool will appear in the multidimensional acquisition tool group. The tool is then active and will be used after hitting the **Start Experiment** button. The experiment type is represented above the button by a graphic.



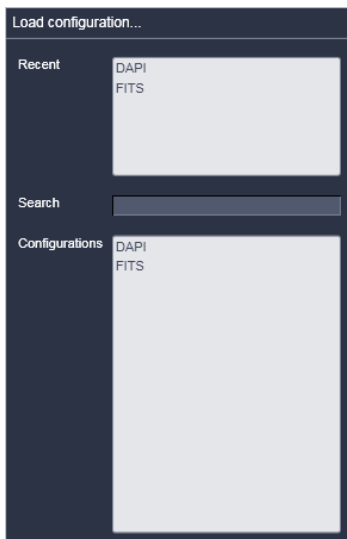
Tools / tools window

Used for setting the microscope and software functions.

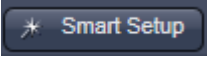
Imaging Configuration



This function allows selecting an imaging configuration. The configuration can be chosen in a list box. Clicking on a configuration loads the selection.



Smart Setup




- Clicking the **Smart Setup** button  will open the **Smart setup** dialog (see section **Smart Setup**).

4.8.1 Tool Groups and Tools

Multiple Columns Layout of tool groups



This function allows moving one or several **tool groups** in a second or third column of the **Left Tool Area**. This is done by dragging and dropping the **tool groups** header. The second column opens automatically if a group is moved and closes if all groups are removed from it.

Undock function of tool windows

This function allows undocking and moving one or several tool windows from its home position in the Left Tool Area and further drags it to any position on the Monitor. This can be done by clicking the  button. The tools can also be undocked by simply dragging the header bar of the respective tool to the desired position. To place a tool back to its home position, click the  button again, drag the tool back to the **Left Tool Area** or click on the grey place holder at the home position of the tool. The last option is particularly useful if one ever gets a too crowded screen and can't find the tools any more. To float all tools back with one click use the  button in the top right corner of the menu bar.

To position the tool window freely on the desktop, use the drag and drop function.

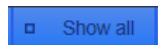
Open a tool window

Clicking on the tool header opens or closes the tool pull down window. The state is indicated by a changing icon (, ) left hand in the tool window header.

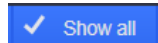
If a tool is undocked from the **Left Tool Area** (float function) it will be opened automatically.

Show all function of the tool window

Clicking on the  button shows or hides additional functions of the tool.



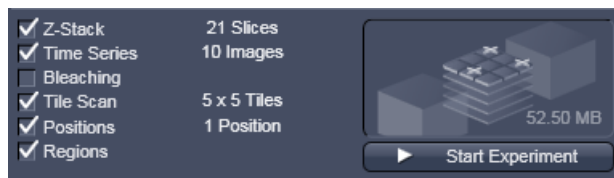
Only the basic functions are shown; this functionality is adequate for most applications.




All the functions are activated. The full functionality of the tool is available.

Activation of tools with respect to a multidimensional image acquisition functions of the tool window

The tools for multidimensional image acquisition can be activated and selected by ticking the respective tick boxes in the selection panel:



Clicking on the  check box of the appropriate tool selects, activates and displays the tool for multidimensional image acquisition. Once selected by the check box, the tool will appear in the multidimensional acquisition tool group. The tool is then active and will be used after hitting the **Start Experiment** button. The experiment type is represented above the button by a graphic.

4.8.2 Context Menu of the Left Tool Area

There are 2 different context menus in the Left Tool Area with different functionalities available.

New Acquisition Document opens an empty acquisition document in the active image container.

Auto Exposure starts the Find procedure. This balances Gain settings.

Find Focus starts the Auto focus. A Line – Z Scan is performed and the focus position is determined upon contrast values.

Scan Overview Image ... opens the **Scan Overview Image** dialog to set the parameters for an overview scan. Clicking the **Scan** button starts the procedure.

Live starts the fast scanning procedure – scans with lower resolution and higher speed.

Continuous scans an image continuously with the currently active scanning parameters.

Snap scans one single image.

Start Experiment starts a multidimensional experiment (Z, T, ...).

Stop stops the scanning immediately

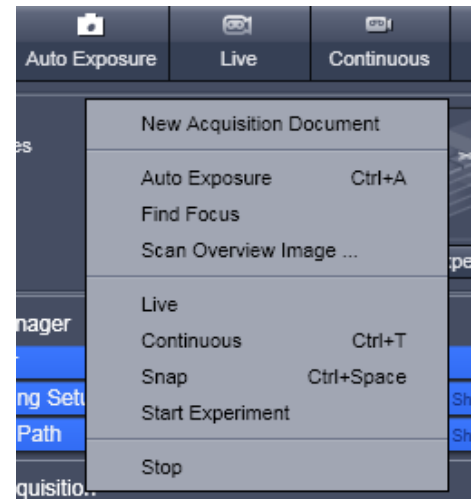


Fig. 21 Context menu of multidimensional acquisition area

Auto Close Mode means that the "oldest" open tool window will be closed automatically if opening a new one leads to a full tool column.

Right mouse click in the Left Tool Area opens a context menu to activate or deactivate the **Auto Close Mode**. A de-activated **Auto Close Mode** will lead to a scrollbar on the right hand side of the Left Tool Area, once a tool column is filled with open tool.

Undocked Auto Size Mode if active, detached tools are automatically re-sized. If deactivated, a scrollbar appears inside detached tools.

Detach tool will open and detach the tool from the tool column.

Open Tool opens the tool inside the tool column.

Move tool group to next column shifts an entire tool group to the adjacent column.

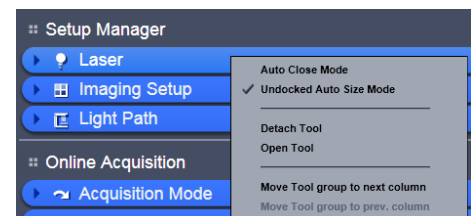


Fig. 22 Context menu of the tool groups area

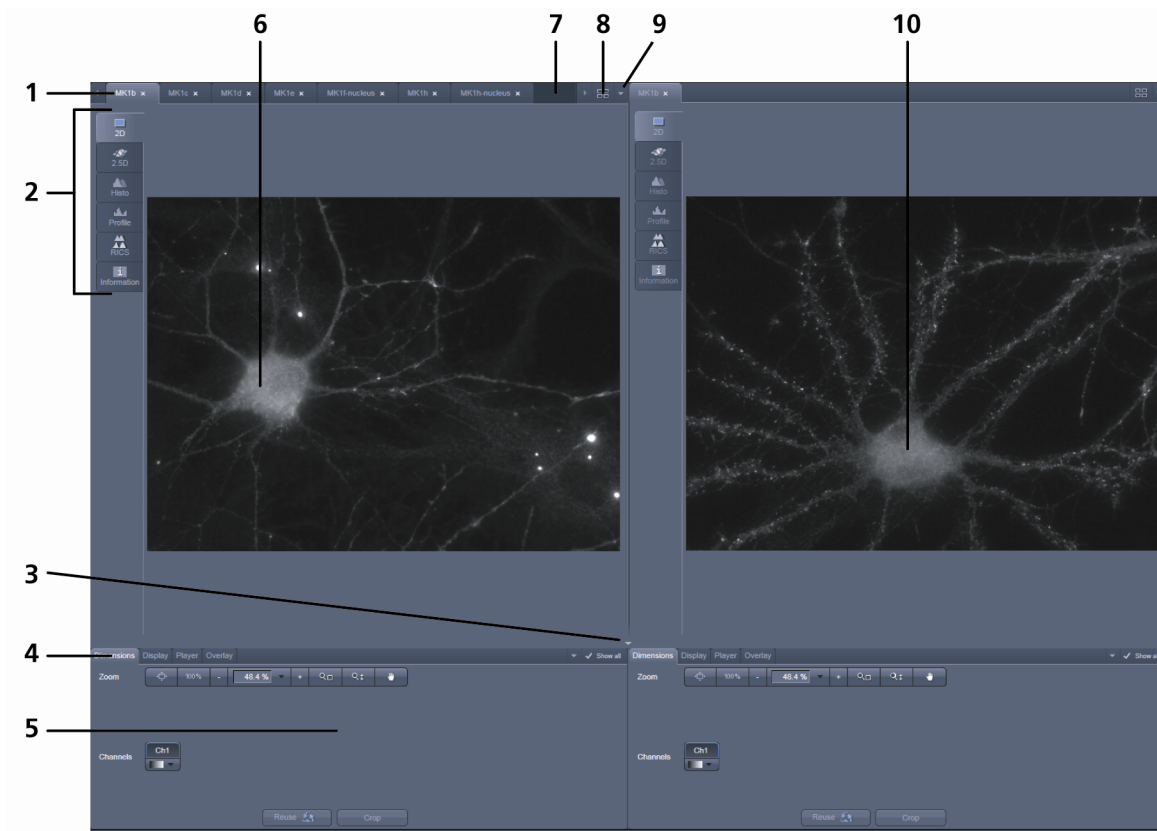
4.9 Center Screen Area

The Center Screen Area is used for displaying scanned images or to show images in the available image views. Using the context menu of the Center Screen Area by clicking the background of a container, the view of this area can be varied individually.

The Center Screen Area can be split in a 1, 2 or 3 container view. So, it is possible to show several images in parallel.

Images can be moved from one container to another using the drag-and-drop function.

4.9.1 Overview of the Center Screen Area



- 1 Image tabs with scroll arrow buttons left and right of container 1
- 2 Image view tabs of container 1
- 3 Arrow down or arrow up button to hide or show the image control area
- 4 Image view controls
- 5 Image control area
- 6 Image container 1 (with opened image window)
- 7 Background area of Container 1
- 8 Expose Mode button
- 9 Arrow down button for fast image selection
- 10 Image container 2

Fig. 23 Center screen area

Image tabs

For each opened image one image tab is shown in the header of the actual container. Three modes can be selected using the context menu of the **Center Screen Area** (see also section **Context Menu of the Center Screen Area**).

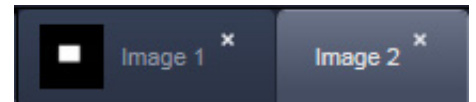


Fig. 24 Image tabs

Image view tabs

Used to select one of the various image views (see also sections **2D View** to **Information View**).

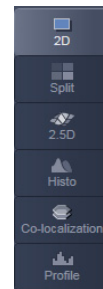


Fig. 25 Image view tabs

Arrow down or arrow up button to hide or show the image control area

Clicking on the arrow down button hides the image control area and increases the image view field of all containers in vertical direction for a larger image display. Clicking the arrow up button shows the image area in all containers once again.

Image view controls

Activates one or more of the various image display and analysis functions (see also section **2D View**).

Image control area

Shows the tools of the selected image display or analysis functions.

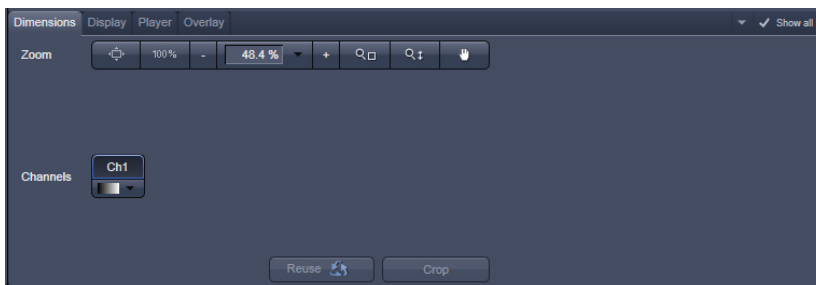
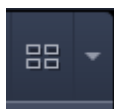


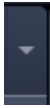
Fig. 26 Image control area



Expose Mode

Changes the one image display to the Expose display. Clicking on one of the image headers changes back to the one image display.

The main purpose of this function is to quickly find an image that might be only one of many open images which are all represented by image tabs on the top. Especially if the image tabs are configured to display only the image name



Arrow down button

Clicking on this button shows a list with all opened images for fast image selection.

Using the drag and drop function, one or several images can be moved into another opened container. If closing a container, the included images will be moved automatically to another open container.

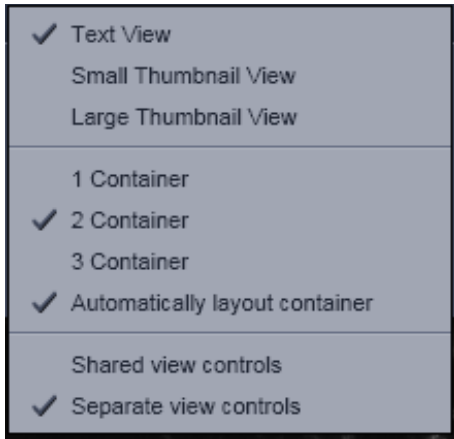


Fig. 27 Context menu

4.9.2 Context Menu of the Center Screen Area

Clicking the right mouse button on the background of the container opens the context menu of the Center Screen Area.

The following functions are available:

Display of the image tabs in the container header

Three options are available:

- Text View
- Small Thumbnail View
- Large Thumbnail View

Number of opened containers

Up to three containers can be opened in the Center Screen Area.

Shared or separate view controls

The display of the Center Screen Area can be changed between shared view controls mode and separate view controls mode.

Separate view controls shows a set of view control tabs for each container. In shared view controls mode, only one set of view control tabs is displayed, spanning the whole bottom area under all 2 or 3 containers. They always apply to the active image/container

4.10 Right Tool Area

The Right Tool Area is used for displaying and handling the opened images, e.g. save or close. The view of this area can be varied individually, e.g. expand or hide the area, change between the view modes.

Expand slider

Dragging this slider to the left side expands the Right Tool Area by decreasing the center tool area.

Dragging the slider to the right side decreases the Right Tool Area up to the default size.

Save button

Saves the selected scanned or changed image. The **Save as** dialog appears.

New image document button

Opens an empty image document in the active container.

Close button

Closes the selected image. The **Close image** dialog appears to close the image with or without saving or to cancel the closing.

Textual View button

Shows images only with the textual characters.

Thumbnail View button

Shows images with the textual characters and an image thumbnail preview.

Big View button

Shows images with the textual characters and a big image preview.

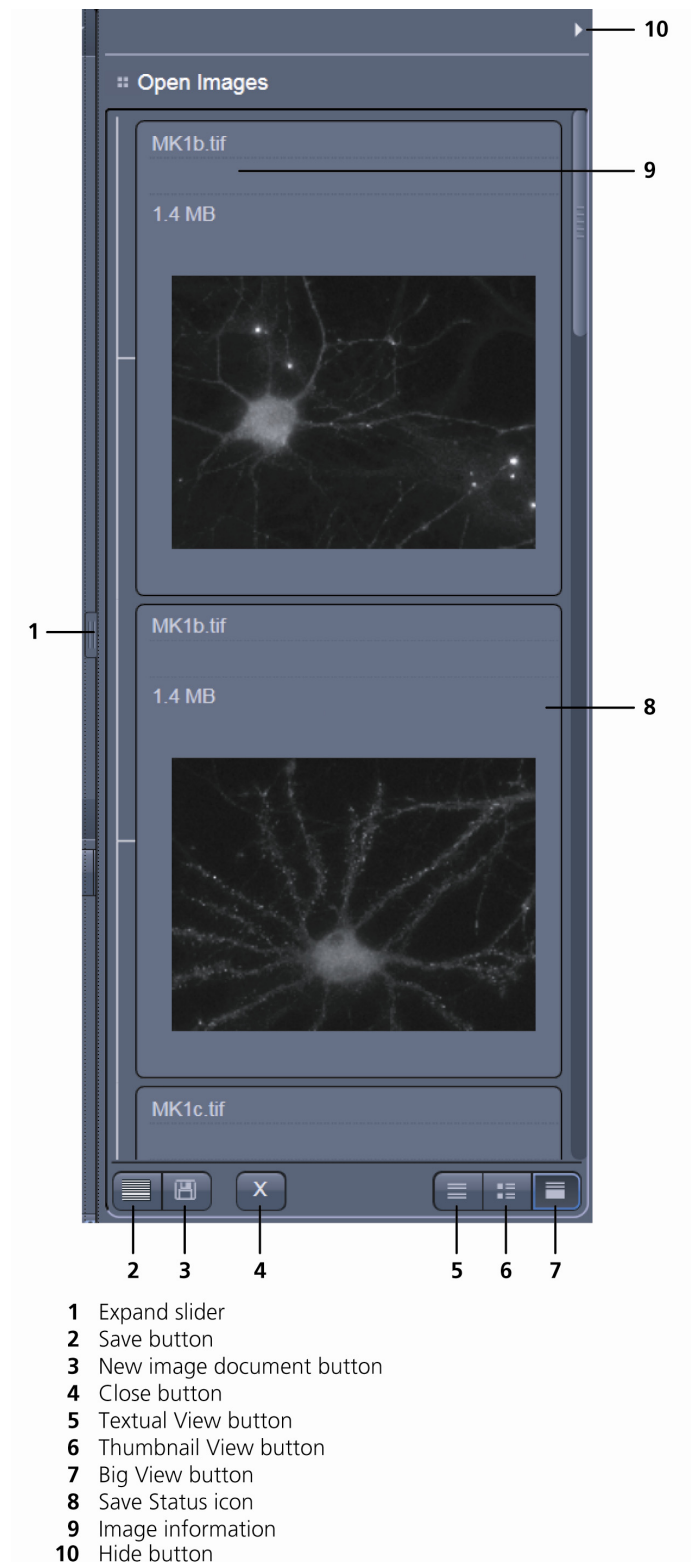
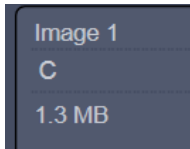


Fig. 28 Right tool area

Save Status icon

This icon appears in the image that is not saved yet.

Image information

Displays the name, type and file size of the image.

Hide button

Clicking this button hides or displays the Right Tool Area.

5 Left Tool Area and Hardware Control Tools

The Left Tool Area contains all tools for system operation, image acquisition, image processing and maintenance. The functions are organized in the three Main tool tabs **Ocular**, **Acquisition**, **Processing** and **Maintain**. This tool area always keeps its position on the monitor.

5.1 Ocular Tab




5.1.1 Basic Controls, Ocular Tool

On the **Ocular** tab, the basic switch between **manual operation** of the microscope (observation of the specimen with the eye) and **imaging** is located.

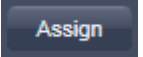
Pressing the **Online** button sets the Ocular tool active – the specimen can be observed and all changes in the ocular tool take effect immediately. When pressing the **Offline** button the system stays in the imaging mode. Changes in the ocular tool do only take effect once the Ocular tab is set in the active mode (**Online**) again. When leaving the Ocular tab the software remembers the state of the **Online / Offline** buttons.

Pressing the **Shutter On** button opens a motorized fluorescence shutter if present on the system. Pressing **Shutter Off** closes this shutter.

All the settings of the tab can be stored in configurations. This includes all filters, attenuation devices, attenuation settings, shutters, and condenser settings but not the objective. Which can be stored, selected and deleted via list menus

when the buttons load , save  and delete  are pressed.

These configurations can be assigned to max. 8 buttons below the configuration panel by clicking

the assign  button. In the appearing dialog each button can be linked to any saved configuration. Using the delete button individual buttons can be removed from the interface.

In the **Ocular** tool, the microscope beam path is represented graphically. All the motorized components of the microscope stand can be controlled via interactive buttons and pull down lists.

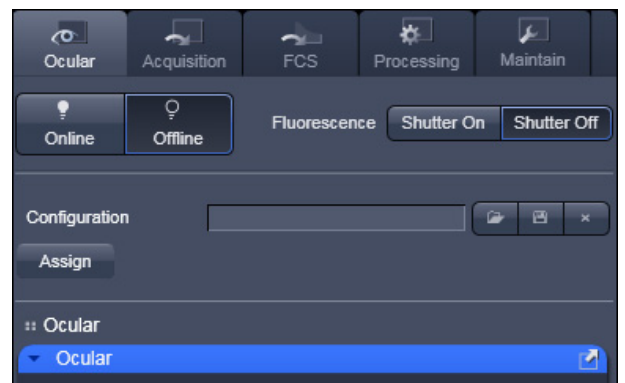


Fig. 29 Ocular tab

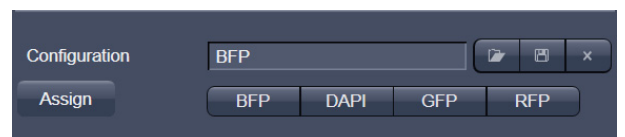


Fig. 30 Configuration panel



Fig. 31 Assign panel

5.1.1.1 Controls for Axio Imager.Z2

- Click on **Ocular** tab in the **Left tool** area. Click **Online** if needed.
- The currently set light path of the microscope is displayed.
- Depending on the level of motorization, the following parts can be controlled:

Reflected Light HBO Lamp	This function controls the reflected light illumination source, e. g. X-Cite 120. An additional dialog opens which allows to open and close the lamp internal shutter and to attenuate the light intensity of the lamp via slider or input box.
Shutter Reflected Light	This turns the rear port mirror to guide the light to the specimen or to block it from the specimen.
Tube Lens	This function allows switching between available tube lenses. The appropriate lens is automatically set when switching between Ocular and LSM in the Main toolbar.
Reflector	Push and click reflector cube can be selected via graphical pop-up menu.
Objective	Objectives can be selected via graphical pop-up menu.
Condenser	Numerical aperture of the condenser is set via input box or slider. Turret position (filter) selected from graphical pop-up menu (only for motorized condensers).
Field Stop	Opening of luminous-field diaphragm (transmitted light) can be set via input box or slider.
Filter	Transmission values for attenuation filter (transmitted) are set via input box or slider for the front or rear filter wheel in accordance with the available filter steps.
Transmitted Light Lamp	Transmitted light is switched on / off via ON button in the Transmitted Light frame, setting of light intensity can be varied via input box or slider. 3200 K color temperature for photo documentation can be switched on via 3200 K button in the Transmitted Light frame.
Shutter Transmitted Light	This function opens or closes the internal shutter for transmitted light.

(1) Microscope settings on Axio Imager for transmitted-light observation

- Set the reflector turret position to **None** and click the **On** button for transmitted light.
- Pull out the push rod (Fig. 33/1) to switch the beam path of the tube in LSM position.
- Control the brightness of the halogen lamp with the potentiometer (Fig. 33/4) or the **Intensity %** slider in the **Ocular** panel.
- Set the required transmission value of the gray filters in the **Filter** frame.
- Set the condenser and the luminous-field diaphragm for KÖHLER illumination.

The laser-scanning mode automatically occludes the halogen lamp even with **Transmitted Light** activated (**On**).

- Click on the **Ocular** tab in the Left tool area. Press **Online** if needed.
- Place specimen on microscope stage.
 - The cover slip must be facing up.

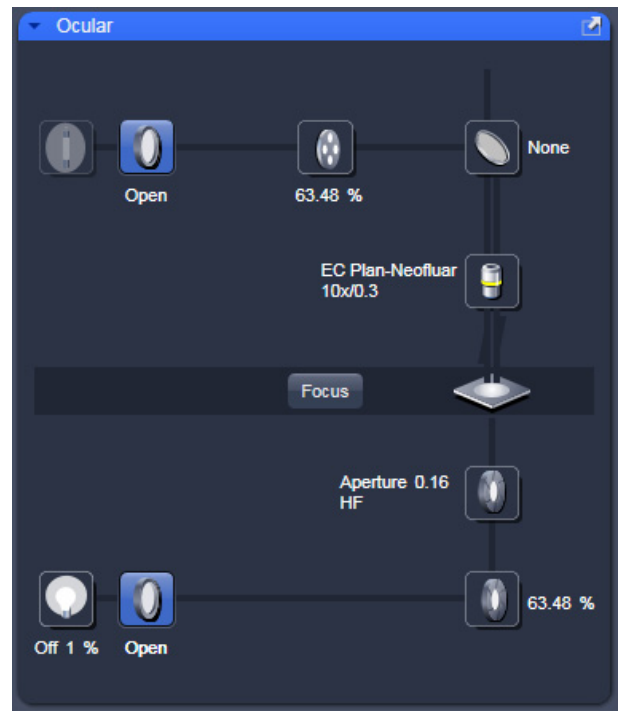




Fig. 32 Axio Imager.Z2 controls in the Ocular panel

(2) Microscope settings on Axio Imager for reflected-light observation (Epi-fluorescence)

- Turn on the HBO 100 W or X-Cite power supply with switch (Fig. 33/8)
- Click on the **RL reflected light** button. The shutter opens.


 To avoid excessive bleaching of biological samples, expose the specimen to the minimum possible irradiation, i.e. keep the irradiation time as short as possible. For this, use the slider in the Ocular panel to attenuate the illumination of the HBO / X-Cite.


- By clicking on the reflector turret button, select the reflector module (filter sets) to suit the type of fluorescence excitation. Proceed as follows:
- Click on the reflector turret button.
- Click on the desired reflector module.
 - The reflector turret moves the selected reflector module into the beam path.

 The FITC filter set consists of an excitation filter for the 450 - 490 nm spectral range, an FT color splitter for 510 nm and an LP long pass filter, which passes emission light wavelengths greater than 510 nm (FSET 09 = FITC, FSET 15 = Rhodamine, FSET 01 = DAPI).
Other filter sets:

DAPI: BP 365 FSET01
FT 395
LP 397

Rhodamine: BP 546 FSET15
FT 580
LP 590

 The filter sets described in this section are examples; other sets are available on request.

 The aperture setting on the condenser of the Axio Imager.Z2 is performed in fixed steps.

5.1.1.2 Controls for Axio Observer.Z1

- Click on **Ocular** tab in the Left Tool Area.
- The currently set light path of the microscope is displayed.
- Depending on the level of motorization the following parts can be controlled:

Transmitted Light Lamp	Transmitted light is switched on / off via ON button in the Transmitted Light frame, setting of light intensity can be varied via input box or slider. 3200 K color temperature for photo documentation can be switched on via 3200 K button in the Transmitted Light frame.
Condenser	Numerical aperture of the condenser is set via input box or slider. Turret position selected from graphical pop-up menu (only for motorized condensers).
Objective	Objective can be selected via graphical pop-up menu.
Reflector	Push and click, reflector cube can be selected via graphical pop-up menu.
Tube Lens	Push and click, tube lens can be selected via graphical pop-up menu.
Shutter Reflected Light	This turns the rear port mirror to guide the light to the specimen or to block it from the specimen.
Reflected Light HBO Lamp	This function controls the reflected light illumination source X-Cite 120. An additional dialog opens which allows to open and close the lamp internal shutter and to attenuate the light intensity of the lamp via slider or input box (depending on the model of XCite connected).

(1) Conventional setting of the microscope Axio Observer.Z1

The Recording of microscope settings works as described for the microscope Axio Imager.

For the conventional setting of the Axio Observer.Z1, proceed as follows:

- Click the **Ocular** button in the **Main** toolbar.
- Place specimen on microscope stage.
 - The cover slip must be facing down.
- In the **Objective** list box, select the required objective.
- Use the focusing drive (Fig. 35/4) to focus the required specimen plane.
- Select specimen detail by moving the stage in X and Y via the XY stage fine motion control (Fig. 35/3 and 2).

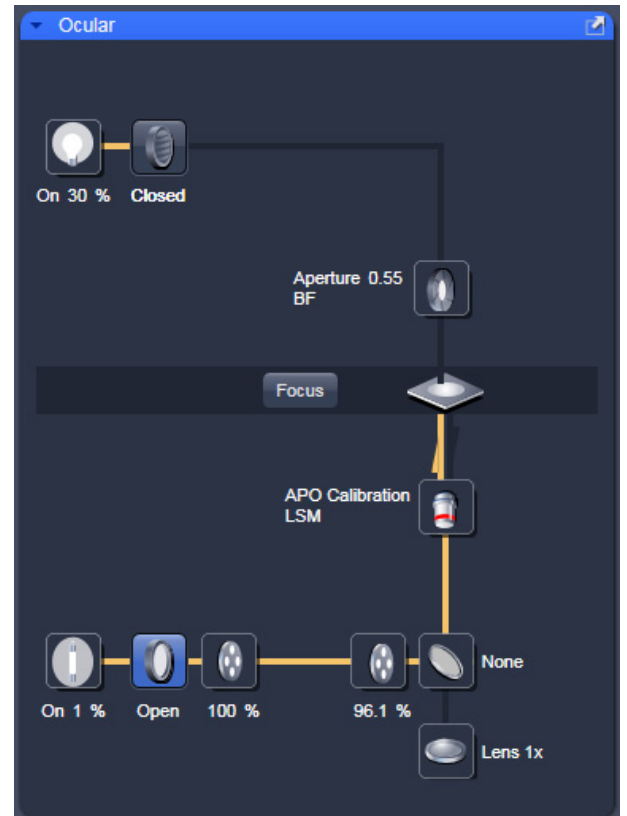


Fig. 34 Axio Observer.Z1 controls in the Ocular panel

(3) Microscope settings on Axio Observer for reflected-light observation (Epi-fluorescence)

- Turn on the HBO 100 power supply switch (Fig. 35/1).
- Click on the **Reflected Light** button and set the shutter to **Open**.
- Click on the **Reflector** button and select the desired filter set by clicking on it.
- The filter is automatically moved into the beam path to enable observation in epi-fluorescence.
- Click on the **Objective** button and select the objective.
- Make sure that the illumination from the transmitted-light is switched off.

5.1.1.3 Controls for Axio Examiner

For setting the Axio Examiner, proceed in the same way as with Axio Imager.Z2 and Axio Observer.Z1. Since the objective turret of the Axio Examiner is not motorized the setting of the desired objective has to be done manually.

The objective in use must be indicated in the **Acquisition Mode** tool.

5.1.1.4 Controls for the Axio Scope with Motorized Z-drive

The Axio Scope (only available for LSM 700) has only a motorized z-drive, all other components are not encoded and have to be set in the software manually for correct functionality. Especially, the objectives are changed manually. The used objective must be set in the **Acquisition Mode** tool.

5.1.2 Ocular Tool – Incubator Control

From ZEN 2010 the incubation settings can be set within the main software.

The settings for Temperature (Ch1 and Ch2) and CO₂ can be set by using the input boxes.

The measured values are displayed next to the input boxes.

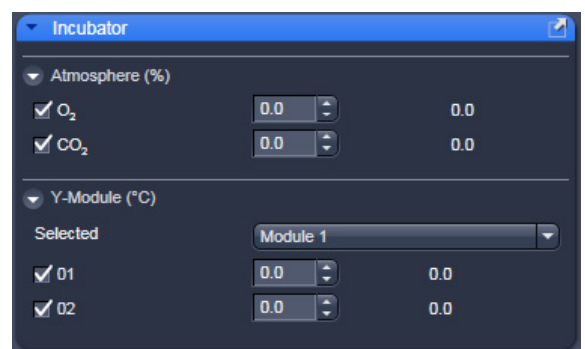


Fig. 36 Ocular tool, incubator control

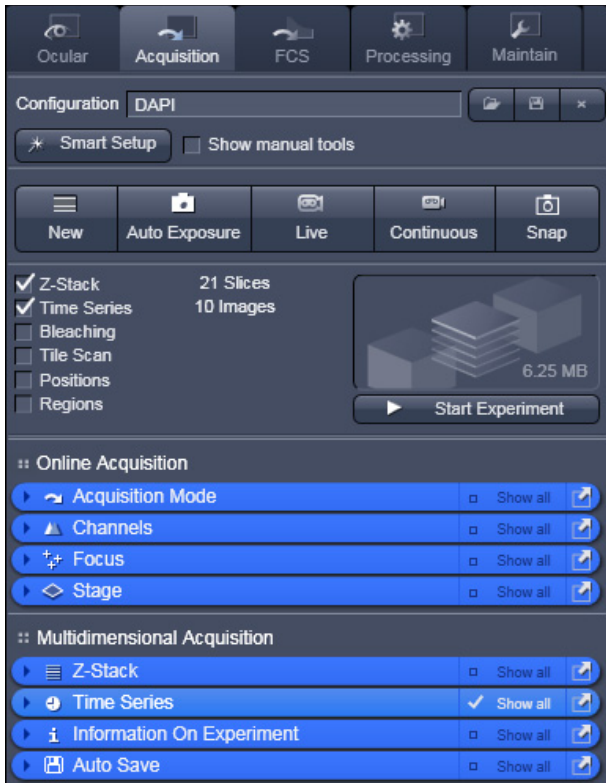


Fig. 37 Acquisition tool tab

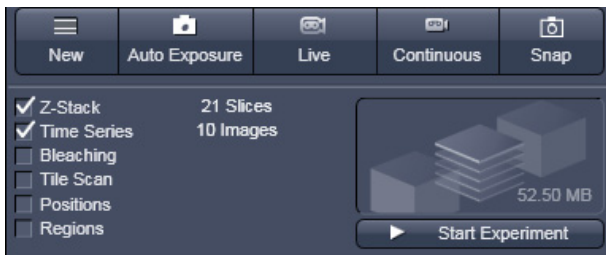


Fig. 38 Main Tool Acquisition tab: Action buttons

5.2 Acquisition Tab

The **Acquisition** tool tab hosts all tools for image acquisition. The content of this tab is specific for the hardware of the microscopy system.

If **ZEN** is started for image processing only (see section **Starting ZEN**) this tab is not available. The same is true for the license free LE version of **ZEN**.

5.2.1 Action Buttons

This main tool area on the top of the **Acquisition** tab provides access to all tools for controlling image acquisition.

The prominent action buttons of this main tool tab have the following functions:

New opens a new image window. The next acquired image is displayed in this image frame.

Auto Exposure produces an image from all active channels and tracks and optimizes the settings of the Gain (Master) and offset for the given laser power and pinhole size.

Live uses the maximum speed for the given image frame and zoom setting to produce an image from all active channels and tracks in the quickest possible way.

Continuous scans images from all active channels and tracks until stopped ignoring settings for multidimensional acquisition. The last scanned frames will stay in the image frame.

Snap produces one single image using all active channels and tracks but ignoring the parameters activated in the multidimensional acquisition tool group.

Start Experiment will start the image acquisition taking into account all settings including those for time series, bleaching, Z-Stack acquisition, and tile scan.

To stop an Experiment:

- a) The action buttons turn into stop buttons and can be used to stop the system.



- b) When performing a multidimensional experiment, the graphical representation of the experiment type (see above) turns into a stop button. Using this button will immediately stop the acquisition. Using the finish current step button will interrupt the multidimensional acquisition after the currently performed step. (i.e. when performing Z over time it will finish the current Z-Stack and then stop the experiment.)



5.2.2 Smart Setup

The tool **Smart Setup**, is an intuitive, user-friendly interface which can be used for almost all standard applications. It configures all the system hardware for a chosen set of dyes.

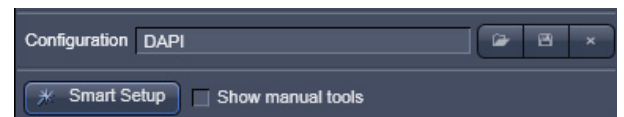


Fig. 39 Smart setup button

Configure your experiment (Fig. 41/1):

- Simply choose the dye(s) used from the list dialog, and assign signal display color(s), see also Fig. 40.

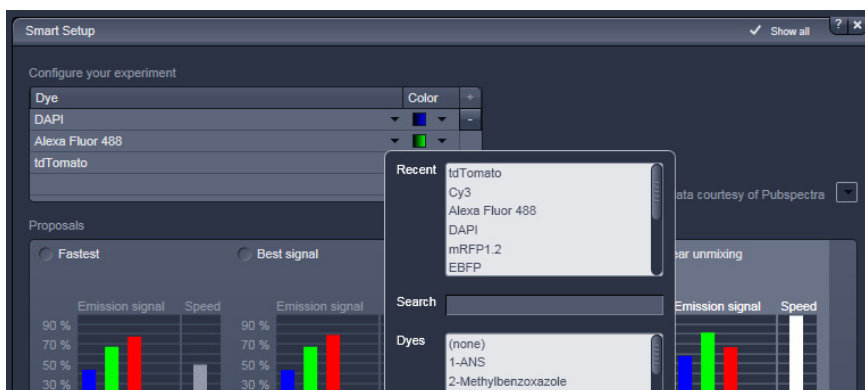



Fig. 40 Configure your experiment

5.2.3 Tool Group Setup Manager: Laser Tool

 The tools **Laser**, **Imaging Setup** and **Light Path** are not displayed by default in the software. They can be shown if the check box **Show manual tools** is checked.

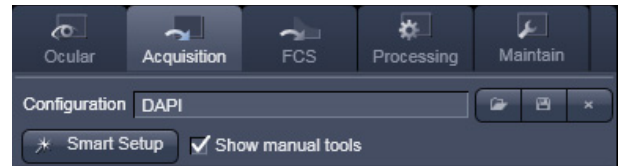


Fig. 42 Show manual tools function

The **Laser** tool shows the types of **Lasers**, the **Laser Lines**, and **Power** status of all lasers available.

Clicking the arrow next to the indicated status of a laser opens a drop down menu which enables the user to switch between **Standby**, **On** and **Off**. Lasers which are On or in Standby are marked with a yellow triangle indicating laser radiation.

The additional laser information panel (available in **Show all** mode) shows the relevant and currently set **Maximum Power**, **Wavelength**, **Status** and **Output [%]** values of the currently highlighted laser (if these values are provided by the laser). Click the arrow next to Laser Properties to open this part of the window. Depending on the type of laser the provided information may vary.

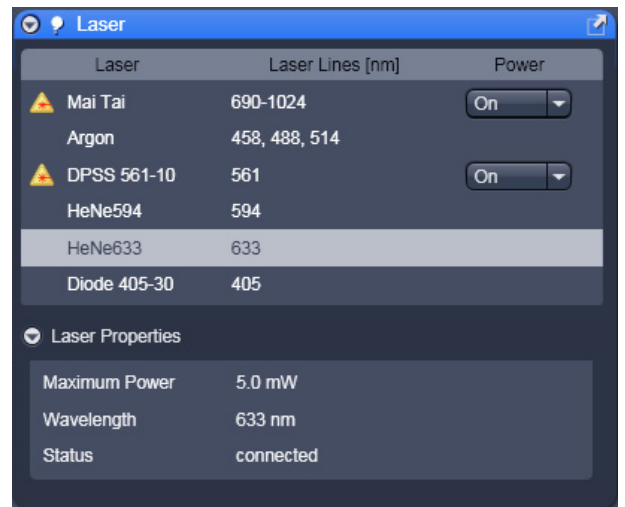




Fig. 43 Tool group Setup Manager: Laser tool


 After switching on the lasers in the laser control window and their status ready the system can be used for imaging. However, for quantitative imaging it is recommended to let the system warm up for 2 to 3 hours.

 Please bear in mind that a cooling phase of at least 5 minutes is required between switching off of the laser via the software and switching off the entire system via the power remote switch.

5.2.4 Tool Group Setup Manager: Imaging Setup Tool



Fig. 46 Imaging Setup Tool

 The Tool group **Setup Manager** is only visible when **Show manual** tools is ticked.

This tool allows the user to setup imaging **Configuration**. If no configuration matching the desired settings for imaging a specific dye or combination of dyes is available, the hardware settings first have to be chosen in the **Light Path** tool (see section **Tool Group Setup Manager: Light Path Tool**) and stored as an imaging configuration.

Three different modes are available for imaging. Select the modes depending on the application.

Channel Mode:

This mode uses one or more detectors as single channels with defined imaging parameters. All hardware parameters set to detect one or more specific signals **simultaneously** are defined as a **Track** and can be stored using a name for this **Track** (available when Show all is active). The parameters include the detector(s) and detector settings like gain and offset, the pinhole size, the filters and dichroics, the laser source(s) and the laser transmission settings.

It is possible to use more than one track to detect different emission signals **sequentially**. Up to 4 tracks with a total amount of 8 channels (incl. monitor diode and transmission channels) can be selected for sequential imaging. Ratio channels (to be selected in the **Light Path** tool) are displayed in addition.

Switch track every ...:

The hardware settings for the different tracks can be switched every frame, every frame but fast, or every line. The latter two options only produce the wanted results if the changes in the settings between each track are restricted to activation/deactivation of channels and changes in their settings and activation/deactivation of lasers or changes in laser power. Additional hardware (filters, dichroics, and pinhole) is not moved even if the second track and all other tracks would require this. These track parameters are overwritten with the parameters of the first track upon confirmation. The confirmation to overwrite the settings is asked in any case when choosing line or frame fast as switching mode. If confirmed with **No**, the switching mode **Frame** will be kept and the settings of the tracks are not changed.

The total set of parameters for one or multiple tracks can be stored as an imaging configuration.

Using multiple tracks is the preferred method to clearly separate weakly overlapping emission signals.

Online Fingerprinting:

The imaging mode **Online Fingerprinting** (Fig. 49) is based on the acquisition of a Lambda stack. It requires using already available emission spectra from the dyes which are used as markers in the imaged specimen. The choice of the emission spectra and the setting of the detection range for the QUASAR detector are defined in the loaded configuration or using the **Light Path** tool.

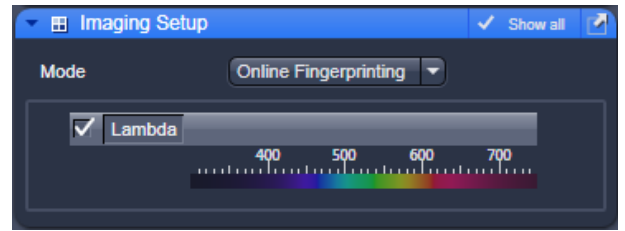


Fig. 49 Imaging Setup tool:
Online Fingerprinting

5.2.5 Tool Group Setup Manager: Light Path Tool

This tool displays the hardware settings of the scan head (**LSM** tab), the beam path to image with the camera (**Camera** tab) or the Non descanned Detectors (**Non Descanned** tab). The settings can be changed in the corresponding tab and used for a new imaging configuration. The configuration can be stored in the **Imaging Setup** tool.

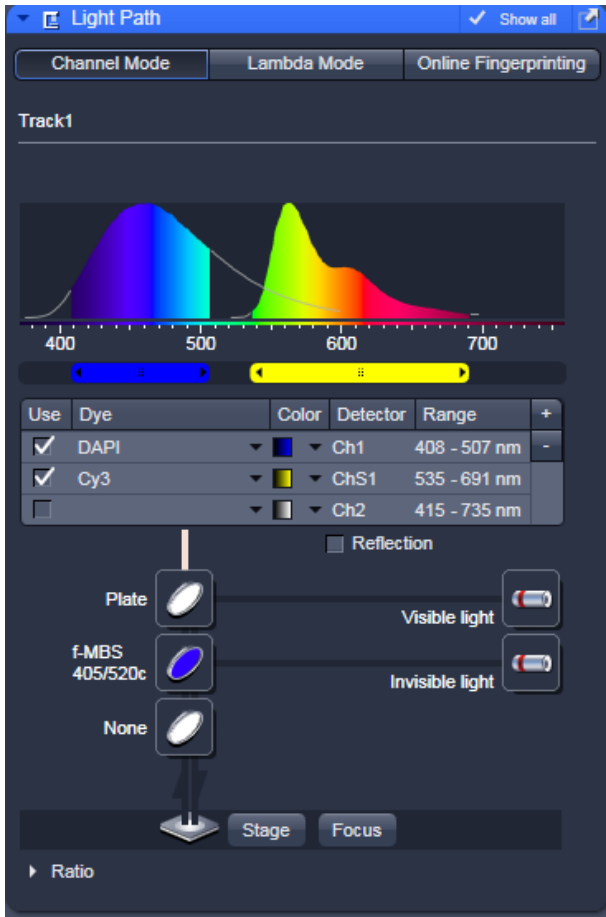


Fig. 50 Light Path tool

The **Channel Mode** tab (Fig. 50) displays the current hardware settings within the LSM 710 and LSM 780 system's scan head for an imaging track. The display changes in accordance with the selection of a track in the **Imaging Setup** tool.


It also allows accessing the focus control, the stage position (the latter is only available if a motorized XY stage is attached to the microscope) and the laser lines. Fig. 50 shows the **LSM** tab when channel mode is selected in the **Imaging Setup** tool including a description of the various icons.

(1) Main dichroic beam splitters (MBS)

- MBS stands for main dichroic beam splitter. This beam splitter is chosen according to the selected laser line(s). It separates the excitation light from the emission signal. HT filters reflect the wavelength indicated and transmit all other wavelengths.
- To select a beam splitter, click on the icon and chose the desired one from the drop down menu.

(2) Detection sliders

To select an emission filter, click on the sliders and set the detection bands according to the dry emission spectra on the top.

 For the configuration of the beam path, please refer to the application-specific configurations depending on the used dyes and markers and the existing instrument configuration listed in the annex.

5.2.5.1 Activation/Deactivation of Channels

- To activate a channel for imaging, check the check box next to channel icon. To deactivate the channel uncheck this box.
- Use Channel D (transmission channel) to acquire an image with transmission illumination using any laser for excitation. This image will display the differential interference contrast (DIC) of the specimen if the according optical hardware for this contrast is put into the beam path in front of the detector. Check the manual of the microscope for setting DIC optics. Be aware that the laser light is already polarized and therefore a polarizer device is not necessary for transmission imaging. This imaging mode allows displaying a DIC image simultaneously to the fluorescence signal of the specimen.
- To assign a specific color to the image of a channel click onto the color icon and select a color from the drop down menu (Fig. 51).



Fig. 51 Drop down menu for selection of the channel color

5.2.5.2 Reflector Turret

The filter wheel FW1 is the reflector turret of the microscope that holds push-and-click filter cubes and fixed beam combiner cubes. When using the LSM 710 and LSM 780 systems for imaging the filter wheel is automatically set to an empty position if not otherwise defined or set by loading an imaging configuration. Standard fluorescence filter cubes are used for observation of the specimen with the eye or with the camera. A click on the icon opens a drop down menu from which the desired filter can be chosen.

5.2.5.3 Stage / Focus

This icons provide access to the control for the focus (position of the specimen in Z) and the stage (position of the specimen in X and Y). But detailed description is given in section **Tool Group Online Acquisition: Focus Tool** and section **Tool Group Online Acquisition: Stage Tool**.

5.2.5.4 Setting of Laser Line and Laser Attenuation

The **Laser** icon provides access to the control of the laser lines and their attenuation (Fig. 52). Activate a laser line by checking the according box. This opens the attenuation slider and input box, which allows setting the desired laser power. Make sure the laser line is indicated as active with a warning triangle. If this is not the case, go back to the **Laser** tool and switch on the laser.

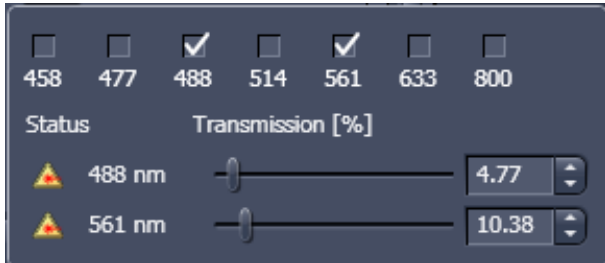


Fig. 52 Laser line selection and attenuation

- Use the **Transmission [%]** slider to set the utilizable laser intensity (recommendation: start at 5 %).
 - The transmittance of the Acousto-Optical Tunable Filter (AOTF) changes accordingly. This allows adapting the laser intensity very sensitively to the job.
 - No more than 8 excitation laser lines (wavelengths) can be active at the same time. If more than eight laser lines are connected to the system the Switch button is active and the required laser lines (if not displayed) must be allocated.
- For this purpose, click on **Switch** and select the required laser line that should be switched to the one not yet displayed.

5.2.5.5 Multiple Tracks Configuration


The **sequential** imaging of **tracks** permits several tracks to be defined as one configuration for the scan procedure, to be stored under any name, reloaded or deleted (see also section **Tool Group Setup Manager: Imaging Setup Tool**).

The multiple tracks can either be configured manually one after the other (identical to a single track) and then stored as recording configuration, or already existing recording configurations can be used and changed as required.

It is also possible to load already stored track configurations (single tracks) in a recording configuration.

The set up is done using both the **Imaging Setup** tool and **Light Path** tool.

In the **Imaging Setup** tool chose **Channel Mode** as the mode for image acquisition. In the **Light Path** tool define the hardware parameters like Laser line, laser attenuation, main and secondary dichroic beam splitters, and emission filters for the first track as described above. Ideally the parameters should be stored as a **Track**. Add a second **Track** within the **Imaging Setup** tool. Make sure it's selected (highlighted) before switching to the **Light Path** tool. Again set the hardware parameters in this case for the second track, and store them under a different name as a Track in the **Imaging Set up** tool. If more than two tracks are requested, repeat this procedure accordingly. Finally the total combination of tracks is stored as an imaging **Configuration** in the **Imaging Setup** tool.

 When storing a configuration all the settings of the **Light Path** plus the Gain (Master), Digital Offset, Digital Gain and Data Depth (see section **Tool Group Online Acquisition: Channels Tool**), the scan parameters like **Frame Size, Zoom, Rotation & Offset**, and **Scan Direction** parameters (see section **Tool Group Online Acquisition: Acquisition Mode Tool**) are stored.

5.2.5.6 Ratio Imaging Configuration

In the **Show all** mode of the **Light Path** tool two additional ratio imaging channels **R1** and **R2** can be defined. These channels are displayed in addition to the maximum of 8 active imaging channels. They provide the possibility to display the ratio between two of the active channels.



Fig. 53 Ratio channels in the Light Path tool

A click on the arrow next to **Ratio** in the lower part of the **Light Path** tool window (Fig. 53)

provides access to the ratio channel interface. A maximum of two ratio channels can be activated. These channels can display the ratio between two of the active imaging channels. The source channels for calculating the ratio have to be selected from the drop down menu next to Source 1 and Source 2. As an alternative to a second channel for the ratio imaging is also possible to choose the first images of a time series of one channel for the ratio metric calculation (e.g. to calculate F/F_0 for single wavelength dyes). The parameters for the calculation are set in the **Channels** tool (see section **Tool Group Online Acquisition: Channels Tool**).

A suitable color is assigned to each of the two **Ratio Channels R1** and **R2**, in the same way as for the photomultiplier channels.



The ratio to be formed between the selected channels can be defined more precisely using one of the four preset formulas in the **Channels** tool window after a click on the relevant ratio button (e.g.: R1) for online display of radiometric or single wavelength dyes. The Set by min/max function (in **Channels** tool window) allows the definition of the display scaling according to the expected minimal and maximal values.

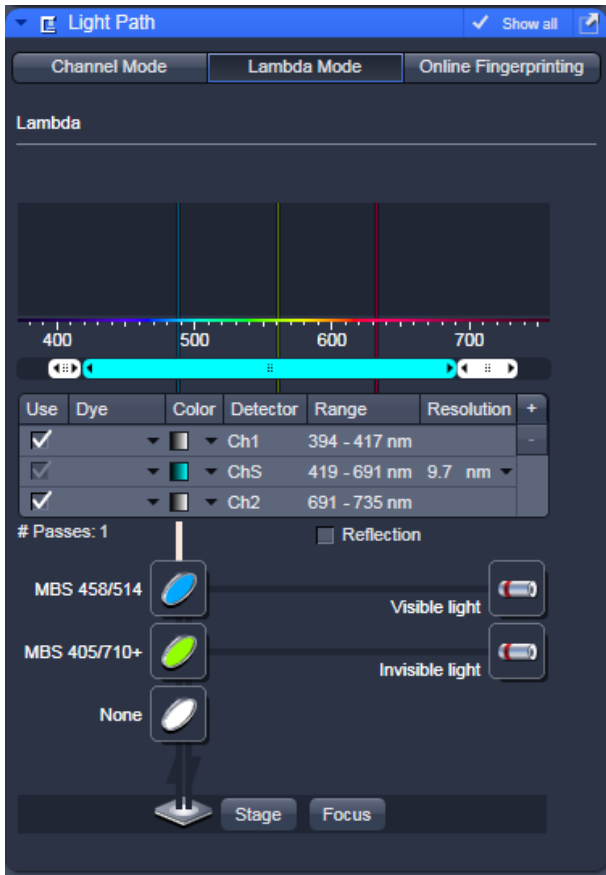


Fig. 54 Light Path tool window; Lambda Mode activated

5.2.5.7 Imaging in Lambda Mode

(to be selected in the **Imaging Setup** tool or in the **Light Path** tool).

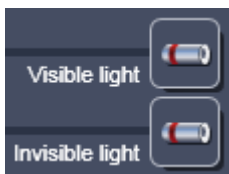
The **Lambda Mode** is recording the overall emission from the sample onto a wavelength-dispersive element and is imaged on a 34-channel detector. All 34 photomultipliers of the detector cover a spectral width of approximately 360 nm, a single PMT covers a spectral range of 9.7 nm. In the **Lambda Mode**, images, image stacks, or time series are recorded in a wavelength selective way.

This new image format is called Lambda Stack. For the acquisition of a Lambda Stack, the complete fluorescence signal can be read out at once. The settings of the beam path for the **Lambda Mode** scanning procedure with regard to the main dichroic beam splitter and the QUASAR detector settings are performed in the **Light Path** tool (Fig. 54).

The QUASAR detector is displayed for spectral imaging if lambda mode has been chosen as imaging configuration in the **Imaging Setup** tool.

The **Light Path** tool displays the laser lines, the main (dichroic) beam splitter, and the spectral range of the QUASAR detector.

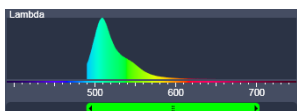
You can change the settings using the following function elements:



Activation / deactivation of the excitation wavelengths (checkbox) and setting of excitation intensities (slider).



Selection of the main dichroic beam splitter (MBS) through selection from the relevant list box.



Definition of number of PMTs out of the 34 PMT Detectors to fit the required spectral range.



Access to the focus control (see section **Tool Group Online Acquisition: Focus Tool**)



Step width in spectral range (9.7 recommended).



Activation / deactivation of reflection.

QUASAR detector settings

Use the two sliders to define the spectral detection range of the QUASAR detector.

Resolution: Step size can be 3.2, 4.9, 9.7, 19.4, 23.3 or 38.9 nm (slightly different values for GaAsP QUASAR).

5.2.5.8 Online Fingerprinting Mode

(to be selected in the **Imaging Setup** tool).

The use of this function permits the selection of reference spectra together with the excitation settings, allowing an immediate display of the unmixed images while scanning. Chose **Online Fingerprinting** in the **Imaging Setup** tool to activate the according display in the **Light Path** tool.

You can change the settings using the function elements which have been described for the **Lambda Mode** plus the following:



Fig. 55 Light Path tool window; Online Fingerprinting Mode

RS1 ... 8

Use	Dye	Color	Detector	Range	Resolution	+
<input checked="" type="checkbox"/>		■	RS1	460 - 674 nm	9.7 nm	-
<input checked="" type="checkbox"/>		■	RS2			

Menu for selecting a display color and reference spectra (reference spectra derive from earlier experiments via Mean of ROI functionality or ACE tool). The unmixed results are displayed during scanning and Lambda Stack data will neither be displayed nor stored.

5.2.6 Tool Group Online Acquisition: Acquisition Mode Tool

The parameters for image acquisition are set using the tool **Acquisition Mode**.

The following scan modes, which can be selected from the drop down menu, are available:

Frame

- scanning of an XY frame (Frame, Frame + Time Series)
- scanning of XY frames with different Z-values (Frame + Z-Stack, Frame + Z-Stack + Time Series)
- scanning of XY frames in defined ROIs (Frame + ROI + Time Series)
- scanning of XY frames with different Z-values in defined ROIs (Frame + Z-Stack + ROI + Time Series)

Line

- scanning of a line in the XY-plane (Line, Line + Time Series)
- scanning of a line with different Z-values (Line + Z-Stack, Line + Z-Stack + Time Series)

Spot

- scanning of a spot (Spot + Time Series)

The availability of the modes is also dependent on the imaging device used e.g. LSM 710 and LSM 780 systems, LSM 7 *LIVE* or camera.

Depending on the selected scan mode the additional parameters for image acquisition will change.

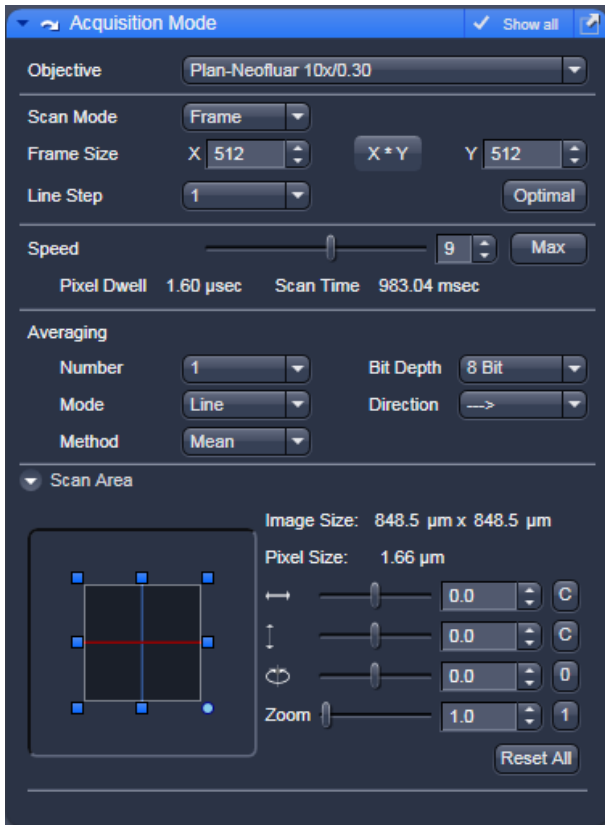


Fig. 57 Acquisition Mode - Frame with LSM tab selected in the Light Path tool

5.2.6.1 Frame Mode for LSM

When the scan mode **Frame** is active, a frame of variable size is scanned pixel by pixel and line by line. The laser beam is moved over the specimen line by line.

The following additional parameters and be set:

Objective, Frame Size, Line Step Factor, Speed, Pixel Depth, Scan Direction, Averaging and Zoom including rotation and offset

A list of available objectives is displayed in the scroll down menu next to **Objective**. Choose one from the list which is appropriate for imaging a specific specimen. Pay attention to match the refractive index of the objective with the refractive index of the embedding medium of the specimen if possible.

- Select the **Frame Size** from the default sizes via the drop down menu clicking the button **X*Y** or type in the required values next to X and Y. Recommended setting to start with: 512 x 512 pixels.
 - It is also possible to enter different values for X and Y. The value for **Y** is freely selectable between 1 and 6144 pixels (integers). The value for **X** must always be an integral multiple of 4. The maximum value for **X** is also 6144 pixels.




- The **Optimal** button sets the image


resolution to an optimal value corresponding to the optical magnification (objective) the zoom and the emission range detected. This provides an image where no information is lost as optimal sampling is achieved.

- Select the **Line Step** size between 1 and 10. Only every n-th line is scanned. The lines in between are interpolated. This fast scan mode is called Step Scan.
- Select the **Scan Speed** from the 15 preset steps via slider or input box. Recommended: 8 for the first scan. A click on the **Max** button sets the maximum speed for the current zoom.
 - The **Scan Speed** determines the **Pixel Dwell** time. In the case of different image formats, the **Pixel Dwell** time is constant for the same Scan Speed, but the **Scan Time** is different.
 - **Pixel Dwell** time of the laser beam on the pixel
 - The **Scan Time** duration of the acquisition for the entire frame

Speed:	1 ... 9	10	11	12	13	14	15
Zoom:	0.6-0.7	0.8-1.2	1.3-1.9	2.0-3.0	3.1-4.9	5.0-8.3	> 8.4
Mode*:	lbda./ch.	lbda./ch.	24-ch	16-ch	8-ch	4-ch	2-ch

* recommendation; depends on system configuration, pixel resolution and bit depth.

- Select **8 Bit**, **12 Bit** or **16 Bit** Data Depth, i.e. 256, 4096 or 65536 gray values.
- Select the **Unidirectional** or **Bi-directional** Scan Direction.
 -  Unidirectional: The laser scans in one direction only, then moves back with beam blanked and scans the next line.
 -  Bi-directional: The laser also scans when moving backwards, i.e. the Scan Time is halved. The online scanner calibration (OSC) will correct for nonlinear distortions of the lines in bidirectional mode. This function (see also checkbox in **Maintain Tab** -> **LSM Options** -> **Hardware**) eliminates most of the deviations of the scanmirrors at the very fast speeds.
 -  The pixel shift between forward and backward movement (double image) resulting from bi-directional scanning must be corrected. For automatic scan correction, click on the **Auto** button. If **Auto** is off the scan **Corr X** and **Y** sliders which are indicated when selecting bidirectional scanning. Zero° rotation requires correction in the X-direction, 90° rotation must be corrected in the Y-direction. If the image was rotated, correction is required in both coordinates. Correction is performed on-line in the **Continuous** scan mode. The size of the shift depends on the Scan Speed.
- Select the **Line** or **Frame** mode for averaging.
- Select the desired scan average method **Mean** or **Sum**.
- Select the desired scan average from the available values **2**, **4**, **8** and **16** in the **Number** selection drop down menu or **Continues** (only for **Frame** average mode).

 The greater the number of averages selected for **Mean** average **Method**, the better the image quality will be; the scanning time will be prolonged accordingly.

Averaging can be performed in different ways, depending on whether the **Mean** or **Sum** method has been activated.

If you are using the **Mean** method, the image information is generated by adding up all scans pixel by pixel and then calculating the mean value.

In the **Sum** method, the intensity values of all images are added up, without a mean value being calculated.

To create the image information using the **Line** average mode, each line (depending on the setting) is scanned 2, 4, 8 or 16 times during Scan Average, and then the average value per pixel is calculated. This minimizes noise interference during the scanning procedure.

If the **Frame** average mode is used to create the image information, the complete frame is scanned 2, 4, 8 or 16 times, depending on the setting. The average value is recalculated after each frame scan.

The **Frame** average mode also permits continuous averaging.

For this, select the **Continuous** option in the **Number** selection box.

As a result of the HDR process, the grey scale is independent from the initial bit depth, but covers a range from 0-1.

Also, the grey stepping is much finer, with much better visibility of weak structures (Fig. 61).

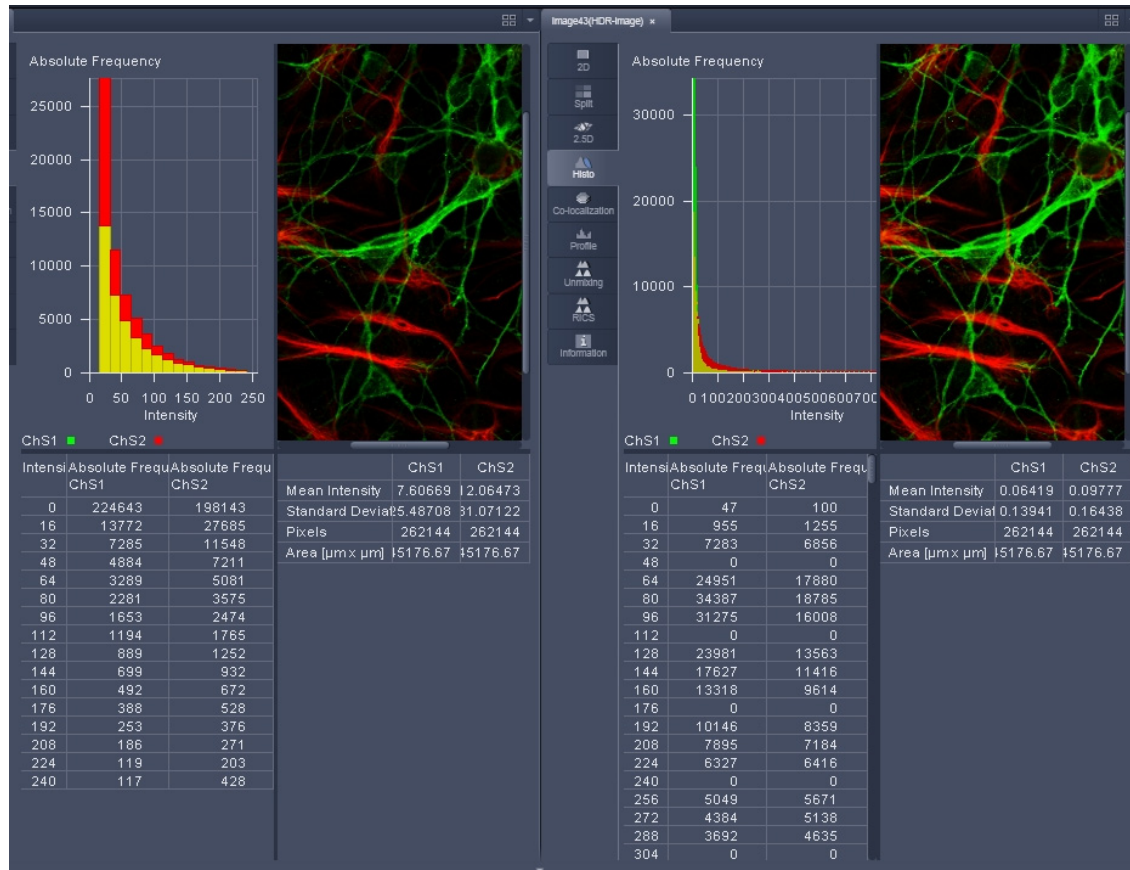


Fig. 61 HDR image display

The **Sampling** mode is a means to improve the image display as it evens out the differences between the very high and the very low intensities in the image. However, it is not suitable for quantitative analysis as the grey level steps become non-linear.

The image re-calculation works already with a single image (**Frame** = 1) and is done in the following way taking **Intensity** 3.

1. Image x 1; cut off of grey levels above the dynamic range; Result divided by 1
2. Image x 2; cut off of grey levels above the dynamic range; Result divided by 2
3. Image x 3; cut off of grey levels above the dynamic range; Result divided by 3

The three resulting images are summed up and again divided by 3.

This procedure is adapted accordingly if a higher **Intensity** number is set.

If two images are **acquired** (**Frame** = 2) and Intensity is still at 3, the second image is rated lower and is multiplied and divided in three steps with the value 4,5 and 6; The then 6 resulting images are summed up and divided by 3.

The image acquisition parameters are not changed for the acquisition of the two (or more) **Frames**.

To use the HDR **Illumination** mode, select **Illumination**. The number of **Frames** is automatically set to **3** (Fig. 63).

The **Illumination** mode changes the laser power (Fig. 64) to acquire a series of varying exposures. The degree of variation is fixed to allow better reproducibility of experiments. The second image is acquired with 3 times more laser power and the third image is acquired with 10 x more laser power.

For the acquisition step with increased laser power, those regions of the image are excluded from exposures where no reasonable data can be obtained with any higher laser power. This mask reduces unwanted bleaching of the sample. The respective ROIs are displayed in an additional image (Fig. 65).

The calculation of the resulting image follows the same procedures as for the sampling mode. However, the regions, which are excluded from a second and/or third illumination step are divided by 2 instead of 3.

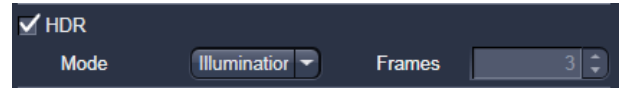


Fig. 63 HDR Illumination mode



Fig. 64 Laser Power setting for Illumination mode

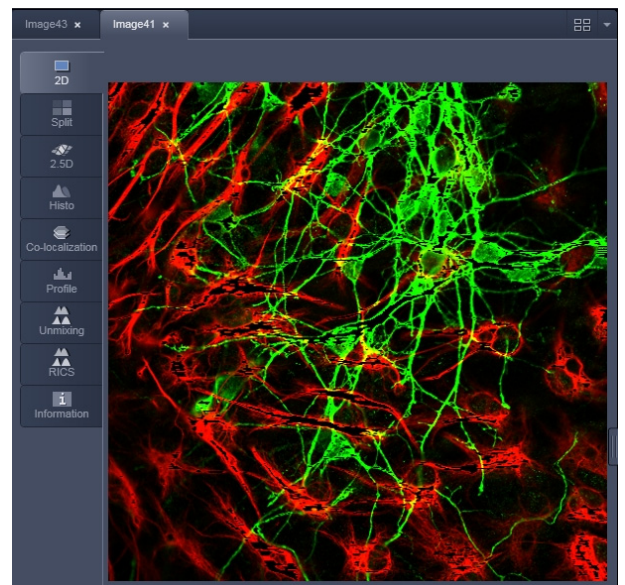


Fig. 65 HDR image display after using Illumination mode


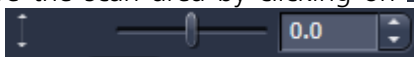
Scan Area


In this panel, the scan field is set for zoom, rotation and offset in relation to the field of view of the microscope. The diagonals of the outer square on the left-hand side correspond to the field of view of the microscope.

The inner square contained in it (rectangle in the case of differently set frame size) represents the scan range and immediately shows the changes made to zoom, rotation and offset.



Fig. 67 Scan Area panel

- Set the desired **Zoom** factor via the slider or by clicking on the small red squares outlining the inner square.
 - The **Zoom** factor can be set continuously in the range from 0.6 to the maximum of 40, and is displayed in the relevant input box. The value 0.6 corresponds to factor 1, and value 40 to factor 66, related to the field of view. From zoom factor 5 onwards, the magnification will be empty.
 - Recommended setting to start with: Zoom 1.
- To rotate the scan area, use the slider or click on the blue dot in one of the corners of the inner square.
 - Recommended setting to start with: Rotation 0°.
- Move the scan area by clicking on  for offset in horizontal direction and  for offset in vertical direction.
- The offset of the scan area from the center of the field of view is displayed online in µm for X and Y.
 - Clicking, holding and drawing the rectangle with the mouse permits the scan area to be moved directly within the field of view.
 - Recommended setting to start with: Offset X = 0, Y = 0

 During the scan procedure, the functions **Speed**, **Scan Corr**, **Zoom**, **Rotation** and **Offset** can be influenced online.

By clicking on the **Reset All** button the scan zoom is set to 1, the XY offsets are set to the zero position and the ratio angle is set to 0°.

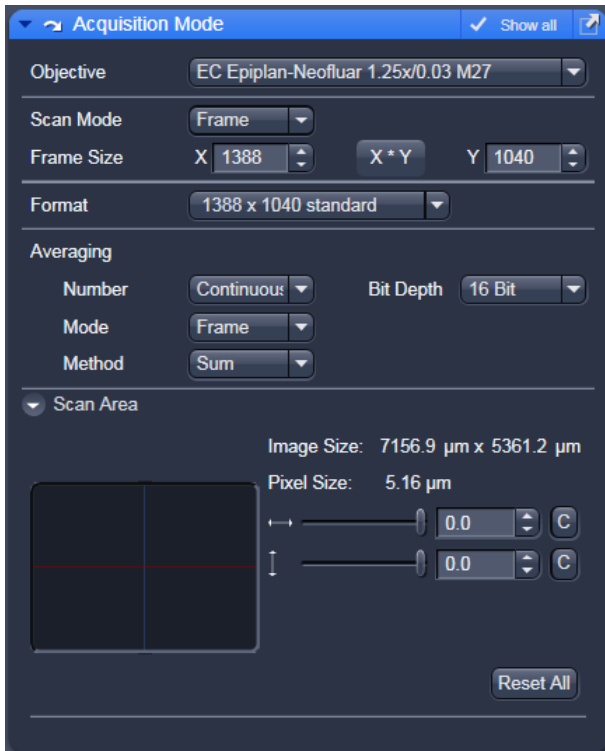


Fig. 68 Acquisition Mode - Frame with Camera tab selected in the Light Path tool.

5.2.6.2 Frame Mode for Camera

When images are acquired with the camera only **Frame** mode is available.

The following additional parameters and be set:

Objective, Frame Size, Format, Bit Depth, Averaging and Offset


The exposure time is set in the **Channels** tool.

A list of available objectives is displayed in the scroll down menu next to **Objective**. Choose one from the list which is appropriate for imaging a specific specimen. Pay attention to match the refractive index of the objective with the refractive index of the embedding medium of the specimen if possible.

- Select the **Frame Size** from the default sizes via the drop down menu clicking the button **X*Y** or type in the required values next to **X** and **Y** all the. Recommended setting to start with: 1300 x 1300. You can select between square formats or free defined frame sizes.

Format selects between a range of default camera resolutions. The 5x5 binning mode can be used for focusing without delay of the image display.

- Select **8 Bit** or **12 Bit** Data Depth, i.e. 256 or 4096 gray values.
- In the scan area it is possible to shift a sub region in the frame using the offset sliders if the **Frame Size** is set to a smaller value than the chosen **Format** sets it automatically.
- The horizontal and vertical **Offset** can be set to zero individually clicking **C**.
- **Reset All** Resets the **Offset** and the frame/sub region to the default value selected in **Format**.
- **Frame** mode is available for averaging.
- Select the desired scan average method **Mean** or **Sum**.
- Select the desired scan average from the available values **2, 4, 8** and **16** in the **Number** selection drop down menu or **Continues**.

 The greater the number of averages selected for **Mean** average **Method**, the better the image quality will be; the scanning time will be prolonged accordingly.

Averaging can be performed in different ways, depending on whether the **Mean** or **Sum** method has been activated.

If you are using the **Mean** method, the image information is generated by adding up all images and then calculating the mean value.

In the **Sum** method, the intensity values of all images are added up, without a mean value being calculated.

5.2.6.3 Line Mode

In **Line** mode, fluorescent or reflected light along a straight or freely definable line is displayed in the form of an intensity profile. The line is scanned pixel by pixel. The laser beam is moved over the specimen along a line.

The following parameters for scanning a line can be defined:


Objective, Frame Size, Speed, Pixel Depth, Scan Direction, Averaging and Zoom including rotation and offset


These functions operate as described in section **Frame Mode for LSM**. **Frame size** in this context sets the length of the line in x direction. The width of the line is one pixel.

Note: A width larger than one pixel is defined as a frame.

If **Line Mode** has been selected, the **Line Select** button appears on the bottom of the **Acquisition mode** tool. It permits positioning of the line to be scanned as required within the **Image** (Frame in XY-plane).

A frame will be scanned and the currently selected scan line and its intensity profile will be displayed. In the **View Control** the **Line-select** tools are available.

The line arrow  is active by default and allows using the mouse to draw a straight line in the image at the position where the line scan should be performed.


Alternatively the scan line  can be defined as a free shape curve (spline).

The arrow selection  is used to move the drawn line within the image.

The standard controls allow defining the color and width of the appearance of the line overlay in the image.

Once a straight line is drawn in the image, the relevant intensity profile along the drawn line will be displayed. In the **Acquisition Mode** tool Zoom, Rotation and Offset values are updated.

- When the **Line Select** button is hit again, a frame will be scanned in such a way that the selected line lies exactly in the center of the Y-axis again and is parallel to the X-axis.

 The position and size of the Line (rotation and offset) can also be changed directly in the **Scan Area** panel of the **Acquisition Mode** tool.
In the **Line** mode, Line Stacks can also be recorded over a defined period of time.

- When drawing a free shape curve (spline) in the **Image** using the mouse, the first click sets the starting point; each further click adds a line segment. A click with the right mouse button ends the line definition.

The scanner represented by a white line immediately begins with the on-line tracing of the defined free shape curve. The laser excitation remains inactive in this process.

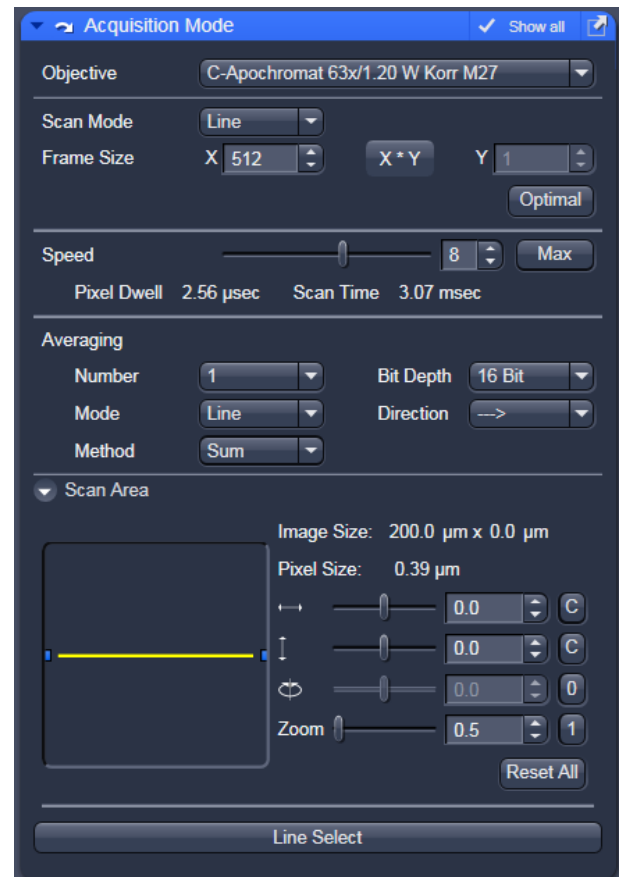


Fig. 69 Acquisition Mode – Line with LSM tab selected in the Light Path tool

If the defined free shape curve becomes too complicated or the selected **Scan Speed** is too high, the following message appears in the status bar:

Maximum scanner acceleration exceeded!

- In this case, reduce the **Scan Speed** set in the **Acquisition mode** tool.
- If the generated contour and the line traced by the scanner are not in coincidence, reduce the **Scan Speed** by a further amount.

If no sufficient coincidence of the two lines can be achieved by the reduction of the scan speed, you have to calibrate the scanner position signal.

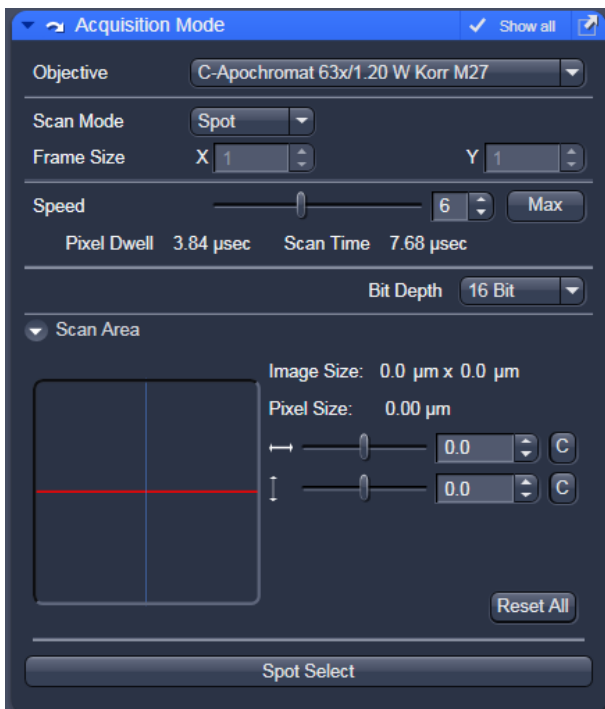


Fig. 70 Acquisition Mode tool - Spot Mode

5.2.6.4 Spot Mode

In the **Spot** mode fluorescent or reflected light occurring from a single voxel xyz is detected. In this mode a spot can be defined by two perpendicular lines in the **Image** using the **Spot Select** button which is located in the lower part of the **Acquisition Mode** tool window (Fig. 70).

The following parameters for scanning a spot can be defined:

Objective, Speed, Pixel Depth and Offset in X and Y (= position within the image)

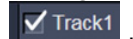
These functions operate as described in section **Frame Mode for LSM**.

In **Spot** mode it is not possible to acquire a **Z-Stack**. After definition of the spot position the only possible scan mode is **Time Series**.

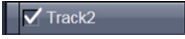
5.2.7 Tool Group Online Acquisition: Channels Tool

The **Channels** tool provides the control of the parameters of the individual detection channels.

It also allows to activate and de-activate tracks by ticking and un-ticking the track check box

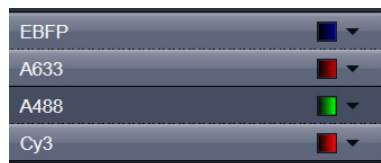


The channels and tracks defined in the **Imaging Setup, Light Path** tool or by **Smart Setup** are listed channel by channel as selectable list entries.

Clicking on the list entry **Track**  displays controls (laser, pinhole, gain, ...) for all the channels in the respective track.

Clicking on the **Channels**  list entry displays the controls for the selected channel only.

Using shift-clicks – the controls can be displayed for any given combination of channels or tracks.



If entered in Smart Setup, the Imaging Setup tool or the Light Path tool the names of the dyes used or the names of the tracks are displayed in the Channel Tool.

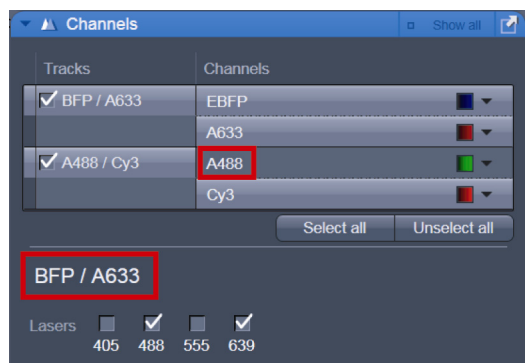


Fig. 71 Channels tool using channel mode (in this case multiple tracks) for imaging

Depending on the selected **Channel** or **Track**, the currently used settings of Pinhole, Gain (Master), Digital Offset, Digital Gain, laser line and laser power are displayed. Below, all available options with **Show all** active are described.

5.2.8 Ratio Channels

The parameters for ratio metric imaging can be set when a ratio channel is selected.

- Click on the button of a ratio channel (e.g. **R1**).
- Clicking on the required tabs enables you to choose from four formulas (**Type 1** to **4**) for ratio calculation. The relevant decimal values can be entered in the input boxes. The entered values remain unchanged even after switchover to another formula and can be reactivated any time.

The formula type activated last is always used for ratio formation during the scan procedure. If the input box does not contain any value at all or no suitable value, the useful value last used will be activated.


The ratio channels are displayed as additional images.

Select the required formula and enter the relevant values.

Letters can be entered into the formula fields which will be valued as 1; it is also possible to make no entry, which will also be valued as 1, but will not be displayed.

Set by min/max allows the definition of the display scaling according to the expected minimal and maximal values.

- Laser lines and laser power are displayed according to each track. It is possible to vary laser intensities (in the same way as in the **Laser** tool or **Light Path** tool) and to program the AOTF for different laser lines using the Switch button.

 All parameters can be varied while imaging.

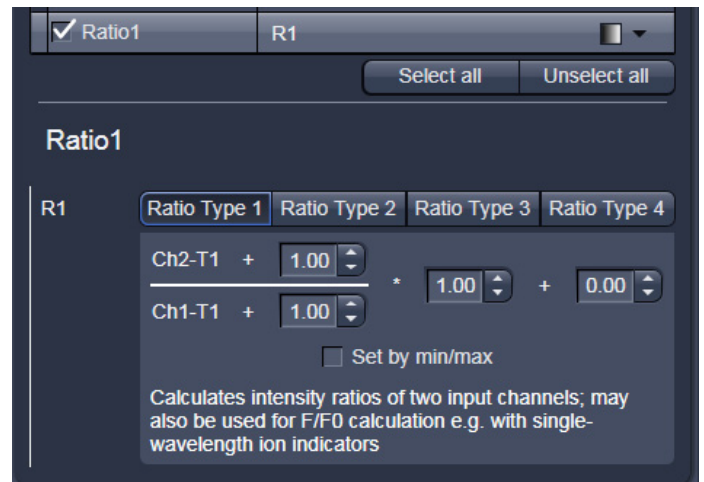


Fig. 72 Channel Settings panel of a Ratio Channel

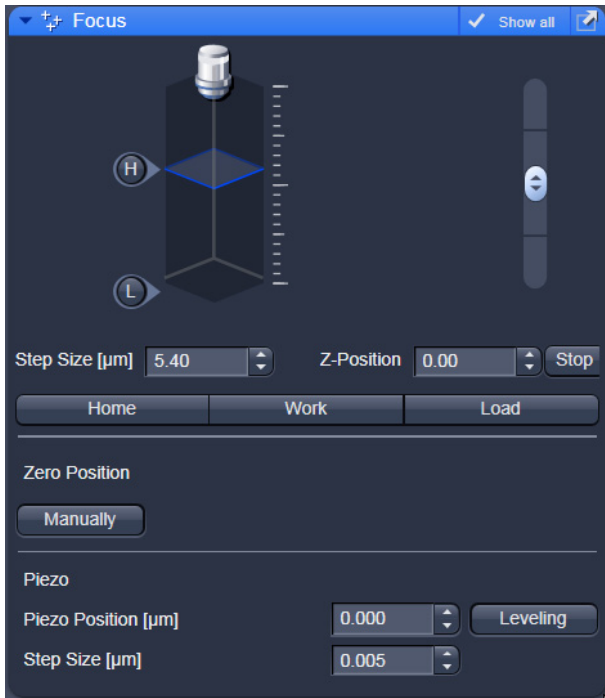


Fig. 73 Focus tool window

5.2.9 Tool Group Online Acquisition: Focus Tool

The **Focus** tool controls the position on Z of the specimen. It controls the internal Z drive of the microscope and, if available, the additional high resolution focus which can either be a Z Piezo focusing device for a single objective or a Z Piezo insert for the stage.

The **Z-Position** of the specimen stage / nosepiece is indicated as a numerical value. This value and with it the focus position can be changed by using the arrows next to it .

The **Step Size**, by which the focus moves when clicking on the arrows, can be set between 0 and 1000 µm.

The Current Z-Position can be **Set** as **Zero**

Position by clicking the **Manually** button.

In addition a focus software joy stick is available to focus with different speeds.

The white joystick can be dragged over these areas to focus.

The stage / nosepiece can be moved to predefined positions.

Zero moves the stage / nosepiece to the position which was set as position zero before.

Work moves the specimen stage / nosepiece to the Work position. This is the position last indicated as current Z position before the **Load** button was pressed.

Load lowers the specimen stage / nosepiece to make it easier for you to change the specimen (or objective).

Use of an optional high resolution focusing device (Piezo objective focus or Z-Piezo stage insert)


The **Piezo Position** is indicated as a numerical value. This value and with it the focus position can be changed. A change of this value updates the value of the microscope focus accordingly.

The **Step Size**, by which the Piezo focus moves when clicking on the arrows, can be set between 0.005 µm and 10 µm.

As soon as the focus position of the microscope is changed (via hand wheel or software), the piezo objective focus is automatically levelled.

- A click on the **Leveling** button moves the Piezo objective focus or Z-Piezo stage insert into the center position of its travel range and the focus position of the microscope is reset to compensate for the leveling. Therefore, the same Z-level remains visible (the current position is not set to zero).

The motor focus of the stand is operated in the same way via the relevant buttons. Moving into the **Work** or **Load** position is always performed via the motor focus and not via the Piezo objective focus.

 Please see printed manual CHAPTER 7 ANNEX of the printed manual for further information on the Piezo objective focus and Z-Piezo stage insert.

5.2.10 Tool Group Online Acquisition: Stage Tool

The following software description applies to systems which are equipped with a motorized scanning stage.




If an LSM 710 / LSM 780 scan head is attached to the side port of an inverted microscope (Axio Observer) take care not to catch your fingers when moving the motorized XY scanning stage to the maximum position left position.

The **Stage** tool allows controlling the movement of the motorized stage, to move to specific locations and to mark locations taking the coordinates in X, Y and Z.



Fig. 74 Stage tool window

The movement of the stage is controlled via the stage software joystick or with the external control. Moving the cursor over the fields shows one or two arrows pointing into defined directions. By clicking on these arrows the stage is moved accordingly. Alternatively the software joystick  can be used to move the stage.

The current position of the stage is updated in the numerical field of the **X-Position** and **Y-Position** in relation to the zero position. Any position can be **Set** as **Zero Position** and by clicking **Move To Zero** the stage directly moves to this position.

This movement of the stage can be halted clicking **Stop**.

The **Step Size**, by which the stage moves, can be set between 1 µm and 1000 µm.

The **Marks** selection allows marking and therefore saving the coordinates of a current position in X, Y and Z (the Z position can be changed using the Focus tool) by clicking **Mark**. The new position is numbered and added to the drop down list. Single or all positions can be deleted using **Remove** or **Remove All**.



If only one selected position is deleted, the position with the next number in sequence moves up one number.



If a new **Zero** Position is **set** the coordinates of the marked positions are updated in relation to the new Zero Position.

The focus is moved to the marked position selected from the drop down menu by clicking **Move To**. Three different values for the **Speed Settings** are available. They can be assigned interdependently to **Speed 1-3**.

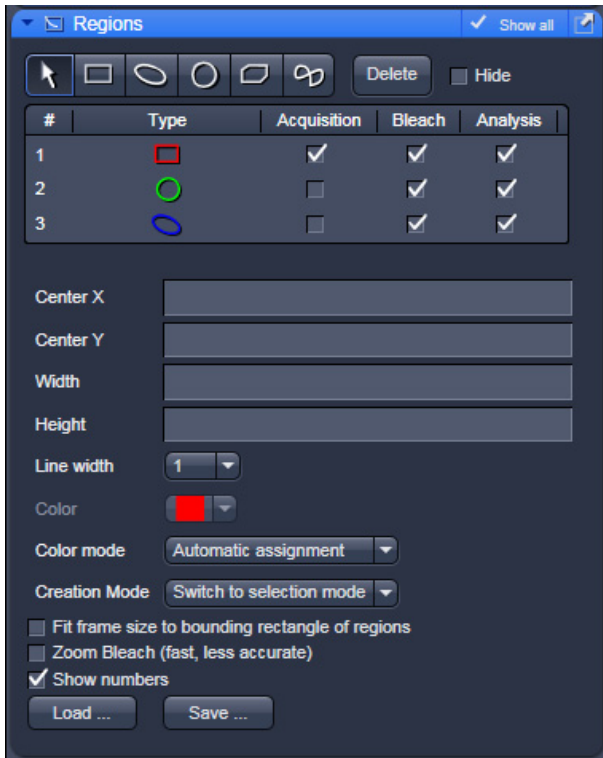


Fig. 75 Regions window

5.2.11 Tool Group Online Acquisition: Regions Tool

The **Regions** tool allows the user to define Regions of Interest (ROI) which are used for image acquisition, sample manipulation (bleaching) and image analysis (Fig. 75).

The control of the laser via AOTF technology enables the restriction of the illumination to the defined region. The sample is only illuminated when data are acquired.

The definition of the regions is done using an actual image of the sample and drawing the regions into this image. This makes it extremely easy to set the regions in the right position and dimension.

The following tools are available:



Selects an existing region in the image. The outline of the region is marked with small rectangles to show it is active. The format and the position of the region can be changed clicking on the rectangles or the region outline and dragging it with the cursor. In addition the numerical values describing the position and size of the region are updated (see below).



Rectangle: Drawing of a rectangle in the **Image** window; click and keep mouse button pressed, drag the rectangle in any direction, let go off the mouse button to end the procedure.



Ellipse: Drawing of an ellipse in the **Image Display** window; first click sets the center point, displayed line permits determination of the extension, second click sets the first dimension, then the second dimension and the rotation direction can be determined, third click sets the second dimension and direction and ends the procedure.



Circle: Drawing of a circle in the **Image** window; click and keep the mouse button pressed to set the center point, drag the diameter, let go off mouse button again to end the procedure.



Polyline: Drawing of a polyline figure in the **Image Display** window; first click sets the starting point, each further click adds a line, double-click on the starting point closes the figure and ends the procedure.



Closed **Bezier:** Drawing of a bezier figure in the **Image** window; first click sets the starting point, each additional click adds a line, double-click on the starting point closes the figure and ends the procedure.

A region drawn in the image will be listed in the regions tool. The regions are assigned with numbers. By checking the box next to **Hide** the regions will not be shown in the image. When highlighting a ROI in the list, the numerical parameters for **Center X**, **Center Y**, **Width** and **Height** will be shown below. In addition the ROI will be set to active in the image.

The regions can be used for different tasks. By checking the appropriate box the ROIs can be used for acquisition, bleaching, and analysis. Any combination of these tasks is possible.

It is possible to change the **Line width** and the **Color** of the outline of the region. The latter is only possible if either **Individual Color** or **Common Color** is chosen in the drop down list of the **Color Mode**. **Common Color** assigns the same color to all regions. If **Automatic Assignment** is chosen in the Color Mode a color will be automatically assigned to each region as it comes. The choice of Color is inactive in this mode.

The **Creation Mode** offers three different settings for defining ROIs. **Switch to selection mode** activates the arrow tool once the region is drawn in the image. **Multiple elements** allow drawing multiple regions of the same type in a sequence. **One element only** restricts the number of ROIs to be drawn in the image to one. Any new region deletes the previous one.

The laser usually scans the entire line length, but is limited in the Y-direction by the ROIs outline. The Scan Time is therefore reduced. It is possible to reduce the movement of the scanner also in the X direction along the line by checking the box next to **Fit frame size to bounding rectangle of regions**. This then corresponds to zooming in onto the region. The frame size will be updated accordingly in addition to the scan time. This applies for image acquisition using a ROI.

If a region is used to define a position for bleaching within the sample, the bleach process can be accelerated by checking the box next to **Zoom Bleach (fast, less accurate)**. In this case the scanner movement will be restricted to the bleach region zooming in onto this region. This may result in a less accurate positioning of the region as the definition of the region has been made in a different zoom in the image. The bleach process will be faster than without this option. The gain in speed is dependent on the speed that is used for bleaching. If a high speed has already been chosen for bleaching the gain in speed will be minimal.

The numbers of the different regions can be shown in the image if the check box next to **Show numbers** is checked.

The regions can be saved to be loaded later on. This process stores all regions currently displayed in the Regions tool in one file.

Fast Z Line performs a fast XZ scan for overviews using a continuous movement of the microscope focus (only in **Line** scan mode and not with the Piezo). The stack size is retained; the interval is adapted depending on the scan speed. Not available in **Frame** mode.


The **Z-Stack Navigation** displays in a graphical manner the navigation in the Rang of the Z-Stack. The blue slice is the current focus position. This interface displays the actual position of the current focus also while scanning. By dragging the blue slice with the cursor, the current focus position changes accordingly. This tool might also be used for defining the first and last position for the Z-Stack.

- ☞ It is not relevant that the first and last position in the software match the absolute first and last position. The microscope will always move against gravity when acquiring the stack ignoring the assignment first and last.
- ☞ When using an Axio Imager.Z2 the precision of the Z-Stack position can be optimized for very critical applications by taking care of the following steps: The approach to the first and the last slice when marking the positions should be made from the same direction as the Z-Stack is finally acquired. As the Z-Stack acquisition is always performed against gravity it is recommended to lower the stage, then approach the first slice by moving the stage up towards the objective, mark it, then go on focusing to the last slice and mark it. During this process be sure to move the stage in this one direction only, do not refocus.
- ☞ To obtain best image quality with Z-Stacks and scanning stages which are critical regarding the focus impulse, a waitstate can be activated in the **Maintain Tab -> LSM Options -> Hardware** menu. Such a waitstate is only beneficial at certain acquisition speeds and not needed by default.

5.2.12.2 How to Proceed Setting a Z-Stack Using Center Mode

The **Center** mode (Fig. 77) allows setting the Range of the Z-Stack in relation to the current **Focus Position** which is indicated as **Offset**. In addition it is possible to use the image of a XZ scan (line scan in Z) for positioning the Z-Stack range. This tool then also allows setting the first and last slice independently from each other and adjusting the center position of the range according to these settings. You should have an idea about the size of the stack when using this mode. It is useful when several Z-Stacks of the same range should be acquired at different positions within the specimen, as the whole range of the stack can be set to a different position at once using the Offset function.

The values for **Number of Slices** and **Interval** are taken over from any settings done in First/Last mode. The **Offset** defines the **Center** position of the stack in relation to the **Focus Position**.

When defining a specific **Offset** the range of the Z-Stack is shifted to a different position in Z. Pressing the  button moves the actual **Focus Position** to the **Center** position and acquires an image at

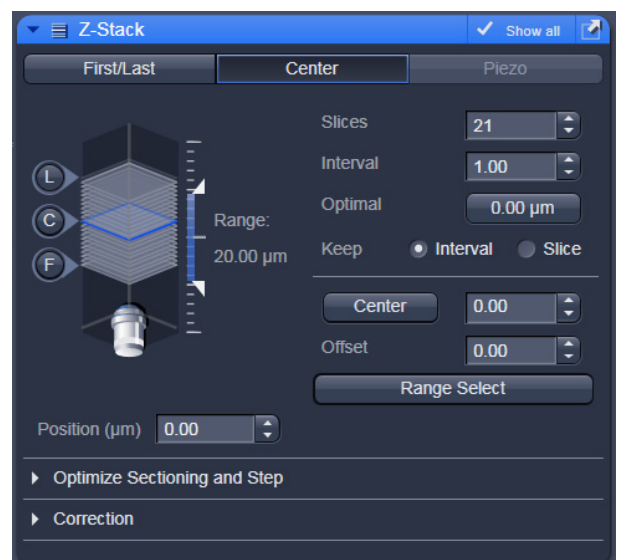






Fig. 77 Z-Stack tool Center mode with Z-Stack Navigation displayed


that position. A Z-Stack is then acquired at the new position when starting the experiment. Hitting **Center** moves the **Center** position back to the actual **Focus Position** setting the **Offset** again to zero.

Use ,  and  to get images from these three specific positions. The **Focus Position** updates accordingly. The **Offset** value then might be set to half of the Interval depending on the Interval value and the number of slices, as with a lower number of slices or a large Interval the real center position of the stack might be just between two slices.

Range Select produces a XZ-scan within the **Range** of the Z-Stack. This helps setting the **Range** of the Z-Stack without continuously scanning complete frames. The position of the first and last slice is indicated with a red line, the **Focus position**, which initially corresponds to the Center position, is indicated as a green line.

Changing the **Offset** value moves the red lines in parallel to the new offset position, the green line, the **Focus Position** is kept constant.  sets the **Focus Position** to the indicated **Center** position setting the **Offset** back to zero and producing an image at the newly defined Focus Position. Alternatively hitting Center sets the indicated Center position back to the actual Focus Position moving the red lines back to the original position and setting the Offset back to Zero. The original values for Number of Slices, Interval and Range are always kept constant.

The red lines can be moved independently from each other allowing an optimal adjustment of the Z-Stack range to the specimen. **Center** sets the green line to the center position between the red lines and adjusts the Focus Position accordingly. The original values for **Number of Slices** and **Range** are adjusted. The **Interval** is kept constant.

 The size and position of the Line where the XY scan should be performed can first be defined using the line scan function in the Acquisition Mode tool.

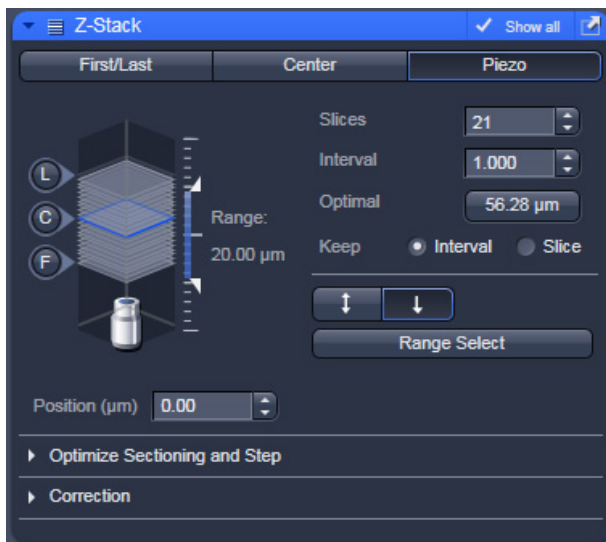


Fig. 78 Z-Stack tool Piezo mode with Z-Stack Navigation displayed

5.2.12.3 How to Proceed Setting a Z-Stack Using Piezo Mode

The Piezo objective focusing device allows stacks to be produced considerably quicker than via the focus of the microscope stand. Clicking on the **Leveling** button in the **Focus** tool moves the Piezo objective focus to the zero position, while the microscope focus moves into the opposite direction at the same time, i.e. the position of the object in relation to the objective remains unchanged. This function is used to set defined initial conditions.

- Define the first and last slice using **Start/End** mode. Activate **Piezo** mode (Fig. 78). The total Range of the Z-Stack is limited to 250 µm when using the Piezo device. Adjusting the value for **Number of Slices** or **Interval** is independent from each other and affects the Range of the stack. The Focus Position is not changed.


When changes are made to **Interval** or **Number of slices** in **Start/End mode**, the values are taken over for the **Piezo** mode provided they are within the Piezo objective focus work range. This also works in the opposite direction.

Range Select produces a XZ scan as described above. Dragging the green line moves the whole stack updating the **Focus Position** accordingly. Dragging a red line changes the **Number of Slices** and therefore the **Range** of the stack keeping the **Focus Position** unchanged. The second red line is set to keep the green line in the center of the stack.

The scanning **Direction** for acquiring the stack using the Piezo can be performed unidirectional or bidirectional. This means the data acquisition is done also when the focus is moving backwards to the initial start position of the stack. This only applies if multiple stacks are acquired in a time series. For one stack only the direction settings have no effect. A correction slider **Corr Z** is available to correct for possible shifts of the stacks in Z.


5.2.12.4 Optimize Sectioning and Stack

The **Optimize Sectioning and Step** function helps to set the **Optimal** for a given excitation wavelength, detection range and used objective. If more than one channel is used, the optimal interval is determined for each channel independently. For given pinhole diameters, half the value of the currently smallest optical section (typically of the channel which detects the shortest wavelength range) is used to determine the optimum interval. For example if the optical section for the channel detecting DAPI is calculated as 1.5 μm , the optimal interval is 0.75 μm (Nyquist criteria). It is recommended to start with setting one airy unit (1 AU) for all channels in the **Channels** tool before starting to optimize.

 Note that the actual values might slightly vary around these theoretical values.

This now produces stronger overlapping optical sections for the channels detecting longer wavelength ranges. The optical sections are not identical and the image data acquired are redundant. Especially for analyzing co-localization of signals from different channels the optical sections have to match.

The function **Match Pinhole** sets all pinholes to match this optimal interval. The pinhole diameter is set such that the values of the resulting optical sections from the different channels are identical and have double the value of the optimal interval.

 Note that the settings of the pinhole might not result in matching optical sections. This is then due to the chosen objective which would require a smaller setting of the pinhole that is mechanically not possible. In this case chose a higher magnifying objective or start with a larger pinhole setting for the channel detecting the shortest wavelength range.

Undo resets the just before altered value.

X:Y:Z = 1 matches the settings in Z to the settings in X and Y. This produces a cubical voxel.



Fig. 79 Optimize Sectioning and Step: Optimal Interval is set starting with one Airy unit for all channels



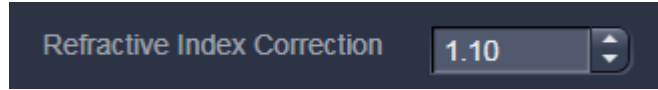
Fig. 80 Optimize Sectioning and Step: Match Pinhole to Step resulting in equal optical sections for all channels



Fig. 81 Auto Z Brightness Correction

5.2.12.5 Correction

The **Refractive Index Correction** considers the different refractive indices between the immersion medium of the objective (n') and the embedding medium of the specimen (n), which can be set between 0.5 and 3.



$$\text{Ratio} = \frac{n}{n'}$$

Auto Z Brightness Correction (Fig. 81) allows setting of different values for the scan parameters **Detector Gain**, **Ampl. Offset**, **Ampl. Gain** and **Laser Attenuation** of up to 10 freely selectable slices within a Z-Stack. During the scan procedure, the values of these parameters are automatically linearly interpolated between the neighboring positions within the Z-Stack. This function can be activated and deactivated with the check box **Use Correction**. **Add** takes the above mentioned parameters and correlates them with the current Focus Position which is then added as a **Position** in the list (for example the first slice of a stack). Adding a new position with a defined set of channel parameters cannot be done while scanning. The positions don't need to be listed in a specific order, the program will sort the values automatically in the background. **Move to** moves the actual focus to the highlighted **Position** in the list without scanning. Starting a **Continuous** scan then allows setting or correcting the parameters and storing them again hitting **Add**. Highlighted positions can be removed (**Remove**) or the whole list can be removed (**Remove all**). The interpolation between the **Positions** in the list can be extrapolated (check the box next to **Extrapolate**) to the actual first and last slice of a Z-Stack if those are not part of the **Positions** in the list.

When **Enable Test** is active, scanning at single positions of the stack or while focusing through the stack is done using the settings of the **Position** list or the interpolated values calculated for the respective focus position. This allows controlling the settings before starting the actual acquisition of the stack.

5.2.13 Tool Group Multidimensional Acquisition: Bleaching

The use of this function permits setting the bleach parameters using the LSM 710 and LSM 780 systems for bleaching in spot, line or frame mode.

The **Bleach Settings** can be saved under a name and reloaded for later use. Existing settings can also be deleted from the list.

Bleaching works in conjunction with the acquisition of a series of images over time. During the sequential imaging of frames, lines or a spot, bleaching of the specimen can be performed according to the bleach settings defined in the **Bleaching** tool.

Start Bleaching after # scans expects a number, which indicates the amount of scanned frames, lines, or spots after which then the bleaching of the sample happens.

Repeat Bleach after # scans expects a number, which indicates the amount of scanned frames, lines, or spots after which then the bleaching of the sample is repeated.

The repeated bleaching also allows bleaching the sample to an intensity value calculated as % of the initial intensity within the region to bleach. To achieve this indicate the percentage value in the box next to: **Stop when Intensity drops to**.

The number of **Iterations** indicates the total amount of scans which are performed for bleaching the selected region (see also section **Tool Group Online Acquisition: Regions Tool**) during each bleach process.

A **Different scan Speed** for the bleaching process can be set independently from the scan speed which is used for imaging. A lower speed results in a longer pixel dwell time, which increases the efficiency of bleaching.

Different Z Position: If this option is active you can set the current stage position as the one in which the bleaching will be done by clicking **Mark Z**. This function is only available using the **Line** or **Frame** scanning mode.

When the imaging is performed in **Spot Mode** (chosen as acquisition mode in the **Acquisition Mode** tool), a **Different XY Spot Bleach Position** can be selected. Click **Spot Select** in the **Acquisition Mode** tool. A new image appears with a green **crosshair**. When clicking and dragging the crosshair a red crosshair becomes visible. The red crosshair marks the spot that is imaged (This is also indicated in the **Scan Area** of the **Acquisition Mode** tool. The green crosshair marks the spot that is bleached. Move the center of the crosshairs to the desired positions.

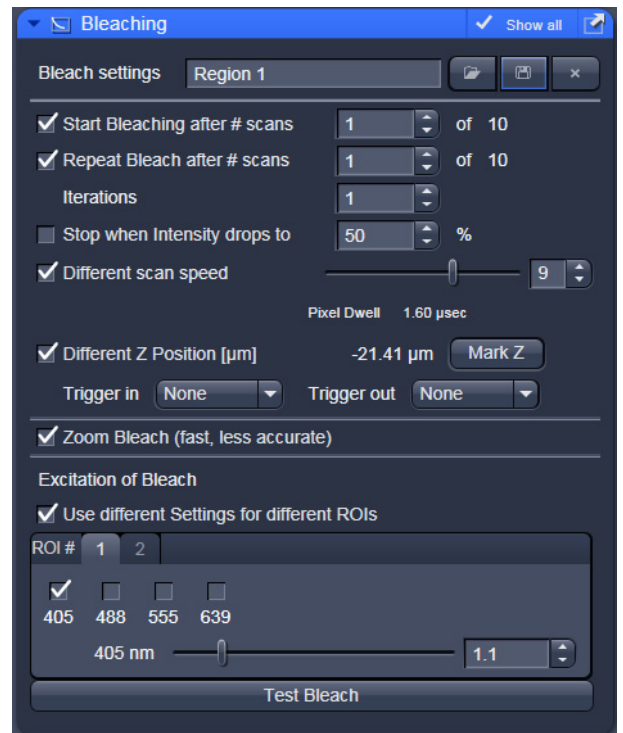


Fig. 82 Bleach Control window

5.2.14 Tool Group Multidimensional Acquisition: Time Series

In the **Time Series** tool the parameters for the sequential acquisition of image frames and lines as time series are defined. Imaging in spot mode is only possible in combination with the settings of a time series acquisition. The options in this mode within the **Time Series** tool are limited and explained below.

The **Time Series** function for frame and line scan offers multiple functions for creating an image series.

To set up a simple time series acquisition it is enough to define the number of **Cycles**, which corresponds to the number of frames or lines, imaged. A maximum value of 100,000 can be set. The amount of data that can be handled by the system is limited. If the maximum amount is exceeded a warning will appear. In this case, it is necessary to either change the destination for data storage and/or reduce the amount of cycles. The limit also depends on the imaging setup and the acquisition mode. Note that it is an upper limit of handling data files but this is beyond the value of 100 Gigabits.

Interval defines a potential time interval, set in milliseconds (ms), seconds (sec) or minutes (min), to separate the beginning of two cycles. A time shorter than the scan time for a frame or line is not effective. The interval time can be changed while scanning.

A **Interval Time** is a potential time interval between the end of one cycle and the beginning of the next cycle. The time and time unit for the delay time is set using the slider and input box of time interval. A cycle interval time is not effective if a cycle delay time is defined (interval is always included in the delay). A total of six different delay times can be defined by adding further lines clicking on the + button. The delete function deletes the currently highlighted delay time. Each delay time can be controlled using the **Trigger** function. If no trigger is set the highlighted delay time will be effective for the time series acquisition. Additionally it is possible to send a trigger signal out at the start of each delay time. Settings for cycle delay times can be stored and reloaded. The delay time can be changed while scanning.

The **Marker** functionality provides the possibility to indicate the start or end of an external process in the data of the image series by connecting this external process to the selected **Trigger In** for that Marker. The **Description** of the Marker is then visible in the image data using the Mean ROI functionality or the image gallery display mode (see section **Gallery View of the ZEN File Browser**). A **Trigger Out** signal can be set with each defined marker. By clicking **Set** a marker is set manually at any time during scanning. A maximum of seven different markers can be defined using the + button. The delete function deletes the currently highlighted marker. Settings for markers can be stored and reloaded. When the image series is stored, all the markers, including the time indication and the comments, are stored along with the image contents.

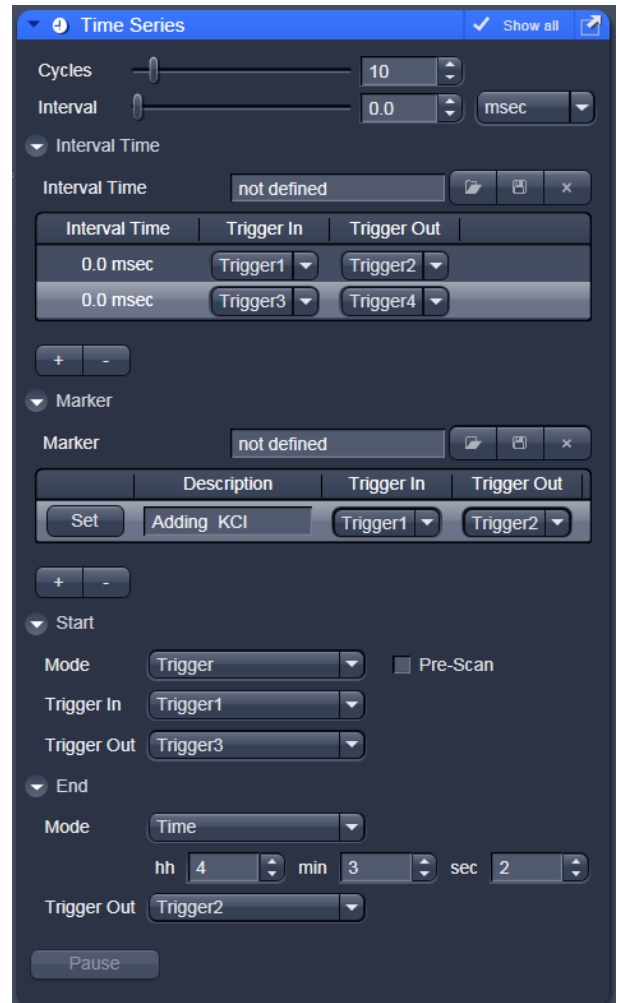


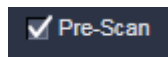
Fig. 84 Time Series tool


The markers visible in the image series, have different colors with the following meaning:

- **red:** manually set marker with time indication and comments
- **blue:** automatically set marker with change of delay
- **green:** automatically set marker at the beginning and at the end of a bleaching procedure

The acquisition of a time series is started using the **Start** action button.

Pre-Scan



If this box is checked, a continuous scan is performed when clicking **Start**, but no images are acquired until you hit the button . This button becomes visible next to **Pause** in the lower part of the control window.

Alternatively, you can start the acquisition using a **Trigger In** or using the system **Time** of the computer. In any case it is possible to send a **Trigger Out** signal with the start of the times series.

When starting a Time Series via Trigger or Time the message **Waiting for Trigger** or **Waiting for Start Time** will then be displayed in the status line when hitting **Start**.

Pause

This function interrupts the Time Series. The labelling changes to **Resume**. The current scan finishes with the end of the frame or line. When Resume is clicked, the Time Series is immediately continued.

The same options as for starting a time series apply for ending a time series.

Focus Stabilizer

This check box activates the Definite Focus unit.



If the time interval between two time points is below 11s – the focus stabilizer will not be activated between the two time points.



If the entered number of cycles is processed without a set trigger impulse been given to end the procedure, the Time Series is finished.

If a trigger signal to end the scan arrives before the cycles have been processed, the Time Series will only be interrupted. **Waiting for Trigger** will be displayed in the status line. The Time Series can now be continued via a new trigger signal or ended via **Stop**.



A Time Series is finished when the end **Time** is reached.

If the entered number of **Cycles** has been processed, the Time Series is finished before the end Time. If the number of cycles has not yet been processed until the end Time, the Time Series is also finished. The end time for the Time Series can be changed online. Bleach times will be added to the total time for image acquisition.



If a time series is interrupted before its programmed end, the programmed number of images will be taken over in the database. However, only those images are stored which were created before interruption of the time series. This is due to the fact that the original image parameters are to be taken over via the **Reuse** function.

5.2.15 Tool Group Multidimensional Acquisition: Tile Scan

This function permits a frame to be created as an overview image of the specimen. The size of the final tiled image depends on the settings for the image format set in the **Acquisition Mode** tool and the number of tiles.

The application of the **Tile Scan** function requires an objective with a minimum magnification factor of 2.5x.

Indicate the number of **Tiles** in **Horizontal** and **Vertical** direction. A maximum of 100 tiles can be set. According to image format the number of **Pixels** changes. According to the objective used for imaging the **Size** of the Tile Scan changes.

In case the stage does not move exactly horizontal to the scan field a **Rotation** value can be set to correct for this (available in **Show all** mode). This can either be calibrated beforehand using a grid slide or any other specimen which displays clearly visible structures in horizontal direction. Acquire smaller tile scans to see the effect of a specific value for Rotation until you find the right one. This value should be taken for the Rotation. Alternatively use the Tile Scan Rotation Macro which provides an automatic Rotation calibration function. Take over this value to the main software before acquiring the tile scan.

When **Bi-directional** is active (available in **Show all** mode) the image acquisition is performed also on the horizontal backwards movement of the stage.

The Tile scan is created around the absolute starting position of the stage.

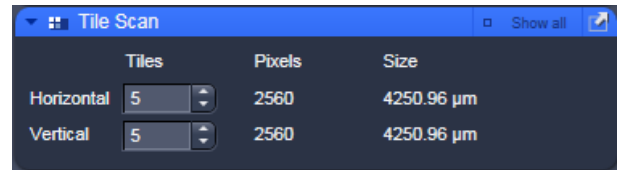


Fig. 85 Tile Scan tool

Tile Scan with StitchArt plus

The StitchArt plus license allows creating tile scans with overlap. The overlap can be used to stitch single 2D images or Z-Stacks three-dimensional.

Centered grid: The current position will be the center of the tile scan.

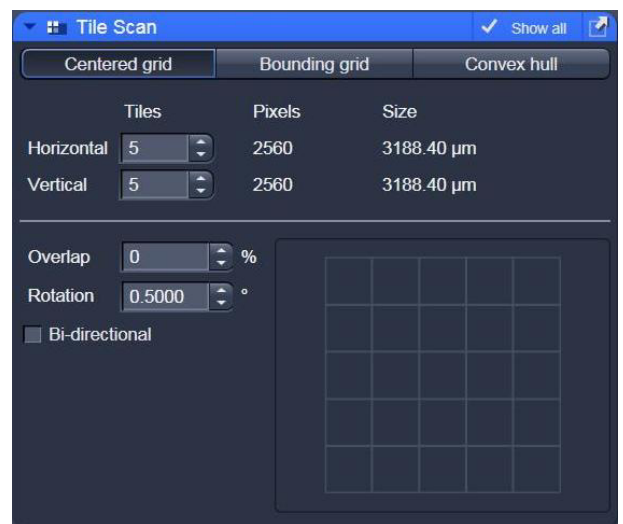
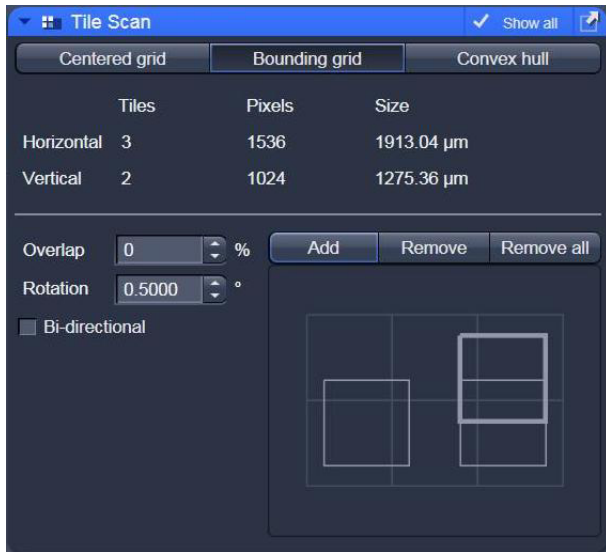
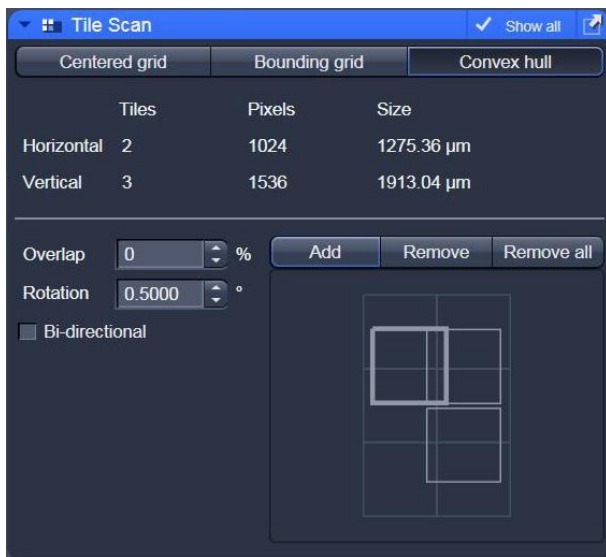


Fig. 86 Tile Scan tool with StitchArt plus



Bounding grid: Positions that should be part of the tile scan have to be marked using **Add**. Using these positions a bounding grid is created, which finally defines the dimensions of the tile scan.

Fig. 87 Tile Scan: Bounding grid



Convex hull: Positions that should be part of the tile scan have to be marked using **Add**. Using these positions a convex hull is created, which finally defines the dimensions of the tile scan.

Fig. 88 Tile Scan: Convex hull

5.2.16 Tool Group Multidimensional Acquisition: Information On Experiment

This tool displays the information of the current experiments in terms of the acquisition mode and type of data produced. In addition this tool allows controlling the use of the multidimensional acquisition modes. When an acquisition mode is selected with the check box, the acquisition mode will be considered. If not, it will be ignored. The check boxes correspond to the check boxes on the individual tool bars. Thus the control over the use of multidimensional acquisition functions is presented in an easy to use overview. Additional information on the potentially acquired image or image series is displayed.

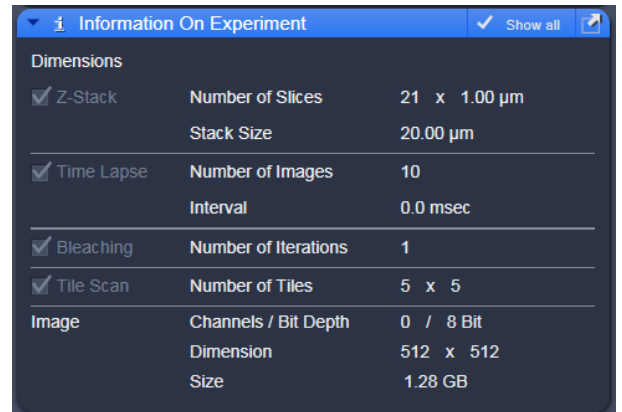


Fig. 89 Information on Experiment


5.2.17 Tool Group Multidimensional Acquisition: Positions

This function comprises two main applications. First, it is used to take images of a specimen at freely defined positions. Second, it is used to image specimens, typically cells, which are grown in sample carriers like plates with a set number of wells.

Using the first tab, **Position List** (Fig. 90), provides the following functions:

Clicking **Add**, adds the current position of the scanning stage to the list of positions. Highlighted positions can be removed (**Remove**) or the whole list can be deleted (**Remove All**). It is also possible to move the stage to the highlighted position clicking the button **Move To**.

The list of positions is consistent with the positions defined in the stage tool (see section **Tool Group Online Acquisition: Stage Tool**).

 Note: When the list of positions is deleted in the **Position list**, it is also deleted in the Stage tool. This is not the case the other way round.

For the image acquisition a method for **Auto-Focus** can be chosen from the drop down list which is either based on the reflection from the cover slip or the fluorescence of the sample. If **Reflection** is selected the system determines the imaging configuration for the auto-focus. If **Fluorescence** is selected, the auto focus looks for the brightest fluorescence signal using the present imaging configuration.

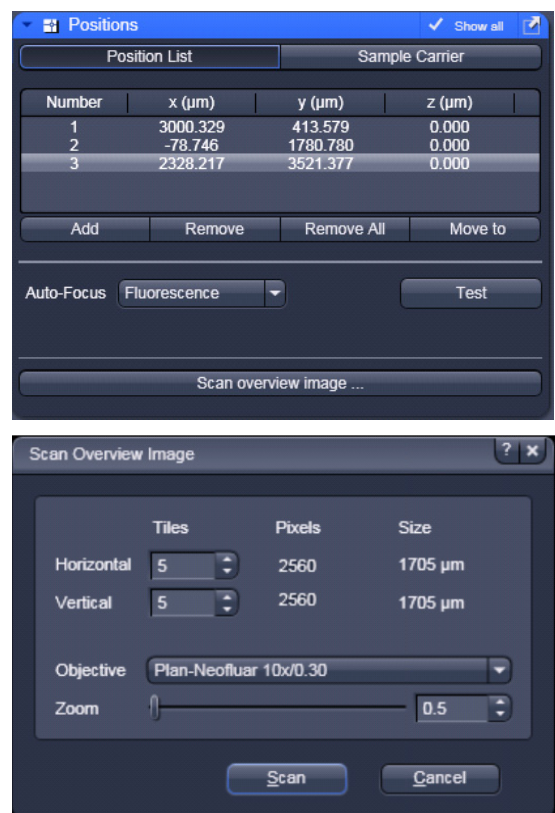


Fig. 90 Positions Tool, Position List tab; sub-tab Scan Overview Image

Scan overview image opens a new interactive window (Fig. 90) to define the number of **Tiles**, the **Objective** (chosed from the drop down menu) and a potential **Zoom** factor with which to scan an overview image. This overview image can then be used to navigate in the sample (i.e. define positions for imaging). **Scan** starts the tile scan, **Cancel** closes the window without further action.

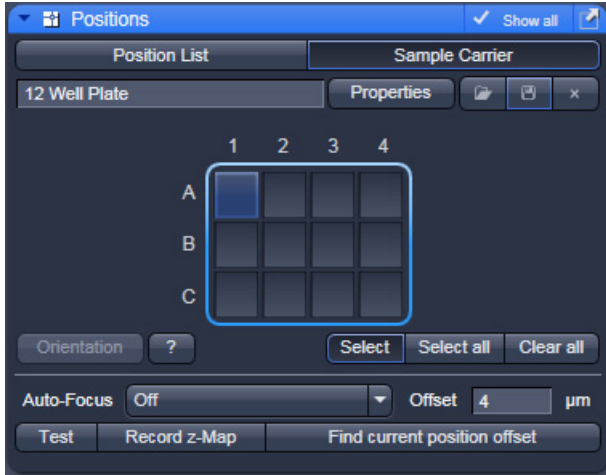


Fig. 91 Positions Tool, Sample Carrier tab

The **Offset** defines the distance between the actual position of the sample in Z and the position of the cover glass, which is determined with **Auto Focus** method **Reflection**. This offset can also be determined automatically. For this, focus onto the sample to be imaged then click **Find current position offset**. The value for the determined offset will then be written into the editing field. To test the performance of the Auto-Focus method (if Reflection is chosen, also the value for the Offset will be taken into consideration), defocus the sample and click **Test**. The auto-focus procedure will be performed at the actual position and an image of the sample will be on the screen when completed.

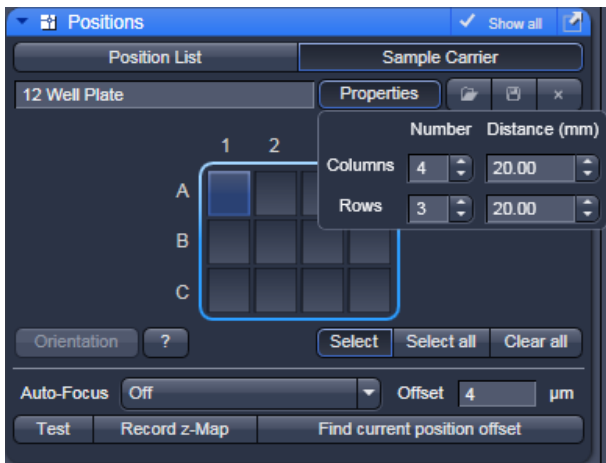


Fig. 92 Positions Tool, Sample Carrier tab, Properties interface

Using the second tab **Sample Carrier** (Fig. 91) provides the following functions:

Define the sample carrier by clicking on **Properties**. This opens the interface to determine the number of **Columns** and **Rows** of the sample carrier and the **Distance** in mm between the individual wells which is assumed to be equidistant within rows or columns (Fig. 92).

To assign the actual position of the stage with a position in the sample carrier, move to the center of a well in the actual plate under the microscope then click **Orientation** followed by clicking the field in the sample carrier representing this well of the plate. This assignment will be kept until changed repeating this procedure.

The positions to be scanned in the sample carrier can be selected. Click **Select**, and then click onto the wells where images should be acquired. With **Select all**, the whole sample carrier will be imaged. **Clear all** deselects all positions.

For this application and additional method for Auto-Focus is available: Auto-Focus Map (Fig. 93).

When this method is chosen, click **Record z-Map** for the system to define the auto-focus position for each of the positions in the sample carrier. This creates a **Z-Map** of the bottom layer of the sample carrier. This map is used to keep the sample in focus until another sample carrier is chosen or the carrier's orientation is changed.

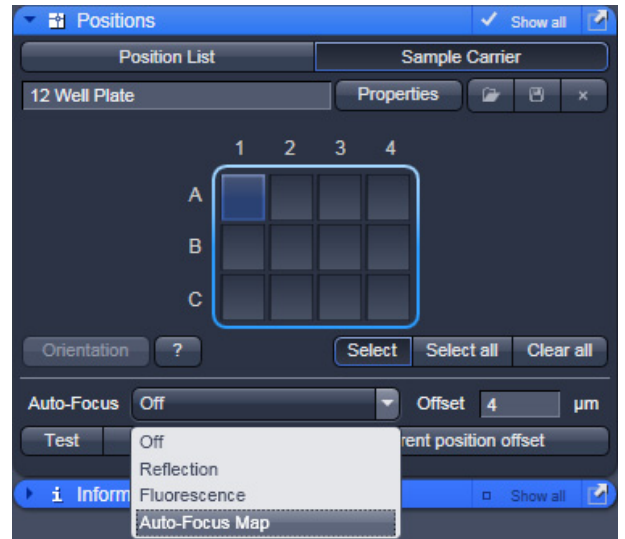


Fig. 93 Positions Tool, Sample Carrier tab, choice of methods for Auto-Focus

5.2.18 Tool Group Multidimensional Acquisition: Auto Save

Separate files can be created for each image dimension by checking the respective checkbox and **Sub-directory** (Fig. 94).

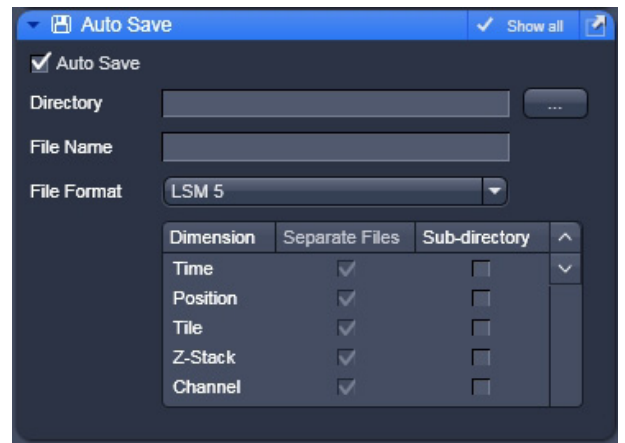


Fig. 94 Tool Group Multidimensional Acquisition: Auto Save dialog

- Activate channel 1 via the check box. You may want to assign a different color to the channel which will be taken over for the initial display of the image. Click the channels icon to open the color table and select the desired color (Fig. 97).
- Move on the slider to set a detection window above.
- If required, deactivate all the other channels (ChS, Ch2, 4, monitor diode, transmission, R1-2) via check box.
- Click on the icon of the main dichroic beam splitter and select **MBS 488/561** or any other MBS indicating the 561 line.

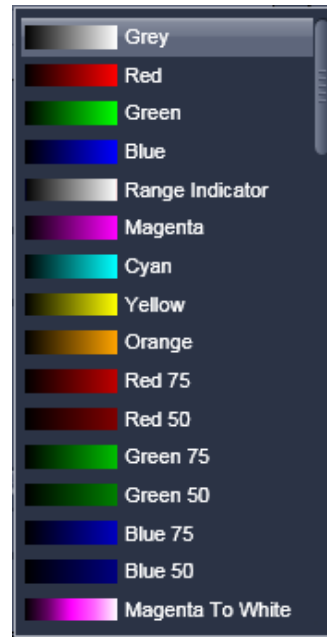


Fig. 97 Channel color selection

The beam path in the **Light Path** tool now displays the way the potential emission signal takes. Channel 3 receives the red part of the spectrum. The settings are suitable for imaging dyes like Rhodamin, TRITC or Cy3.

For overlaying fluorescence and transmitted-light images, click on the **T-PMT** (Transmission) button in the **Beam Path and Channel Assignment** panel.

All transmitted light applications like

- phase contrast
- differential interference contrast (DIC)
- polarization contrast (Pol)
- darkfield

can be performed if the hardware of the microscope is equipped with the necessary optics. We recommend DIC as standard contrast because the suitable objectives have a higher transmission than the ones for phase contrast. This enhances detection sensitivity.

In case intensity fluctuations occur e.g. with 405 nm lasers, a different attenuation level should be chosen. In case this is not possible, a different laser line needs to be selected for the T-PMT acquisition or track.



Fig. 98 Light Path tool window

5.2.19.3 Defining the Detection Parameters

- Activate the **Channels** tool (Fig. 101).
- Set the **Pinhole** to one Airy Unit clicking **1 AU**.
 - The pinhole diameter should be so small that there is still enough variation for the setting of the Gain (Master) and that sufficient image information is still available. 1 Airy is a good value to enable a confocal fluorescence XY-image to be obtained.
 - A small pinhole diameter will increase the depth of focus, but reduce the light intensity received by the PMT photomultiplier (for reflection mode confocal images start with a pinhole value of 0.5 Airy Units).
- Use the **Auto Exposure** button.
 - The system determines the settings for the Gain (Master) and digital offset to match the scan speed, pinhole size and laser power.
 - Finally, the system builds up the image.

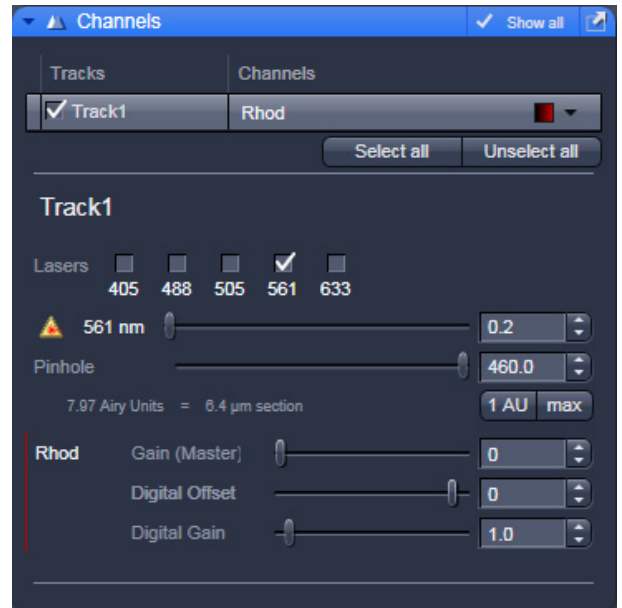


Fig. 101 Channels tool

5.2.19.4 How to Optimize Image Quality

As a rule, the first scanned image is not ideal, since the settings of the laser and therefore also the photomultiplier might not match the light output. More often than not, the screen image is dull and needs subsequent optimization.

- Use the lookup table **Range Indicator** (see section **Dimensions**). This display mode shows overexposed regions in red and underexposed regions in blue. Some red and some blue pixels should be visible to ensure the signal is spread over the dynamic range of the detector and no image information is lost.
- Start a **Continuous** scan and quickly adjust the laser power, Gain (Master) and offset to set the image into the dynamic range.
- Try to lower the impact of laser light onto the sample. Reduce the laser power and adjust the gain accordingly.

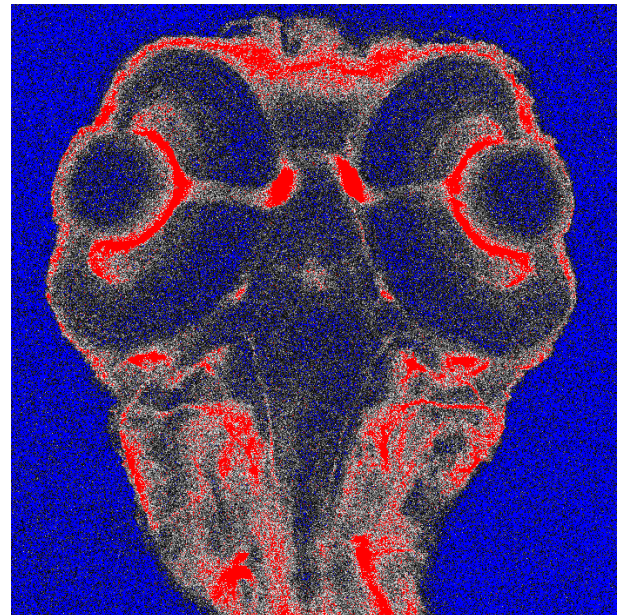


Fig. 102 Image displaying bad adjustment of gain and offset (blue regions are underexposed, red regions are overexposed)




Fig. 103 Image displaying good adjustment of gain and offset

- To adjust the black level (background), use the **Digital Offset** slider so that areas without picture content just show a trace of blue.
- If necessary, re-amplify brightness with the **Digital Gain** slider.
- Stop scanning.
- Save the imaging configuration again as this time it will also save the correct settings for the detector, the laser, and the pinhole.

The signal-to-noise ratio can be substantially improved by reducing the scan speed to an acceptable level and averaging over several scans (i.e. with an average **Number** greater than 1 for the **Mean** average **Method** in the **Scan Control** window).

- Use the **Speed** slider in the **Acquisition Mode** tool set the slowest acceptable scan speed.
- In the **Number** text box of the **Averaging** panel enter the number of images to be averaged.

 Image optimization can be achieved faster if you select a smaller frame, since less data have to be processed.
The greater the number of averages selected using **Mean** as average **Method**, the better the image quality will be; the scan time is prolonged accordingly.

A similar procedure applies for image optimization if more than one channel is used and simultaneous image acquisition is performed.

Make sure the suitable lasers are switched on and the channels are activated.

Pay attention to address the right channel when pinhole size, detector gain, and amplifier offset are controlled as these are set individually for each channel.

Use the split view (see section **Split View**) to see the effect of the controls onto each channel separately.

If the acquisition is performed sequentially in with multiple tracks it is faster to activate only one track at a time for image optimization.

5.3 Processing Tab

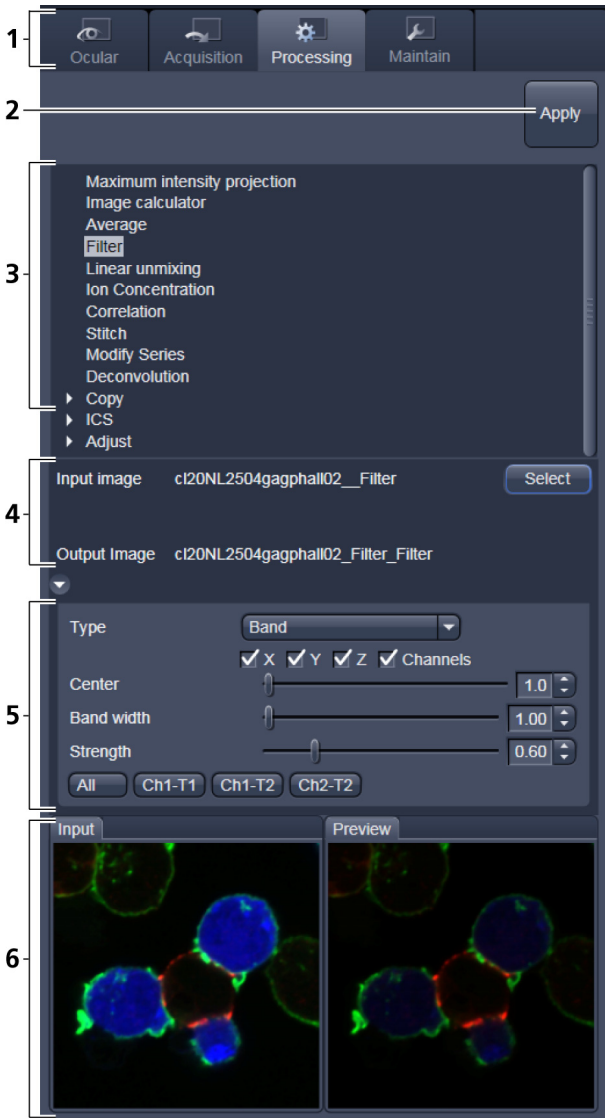
5.3.1 General Structure of the Processing Tab

The functions of the **Processing** tab are designed to cover a large range of Image Processing methods to process and analyze already stored as well as just scanned images including mathematical operators and algorithms.



Fig. 104 The Main Application window with the Processing main tab activated

By clicking on the third of the four Main tool tabs in the top left corner of the **Main Application** window (see Fig. 104), the list of available processing tools becomes available.



- 1 Main tool tabs
- 2 Apply button
- 3 Available processing methods
- 4 Input image selection panel
- 5 Method-specific settings
- 6 Input and preview thumbnails

Fig. 105 The Processing tab structure

The **Processing** tool tab is structured as follows (see Fig. 105): On the top, under the **Main** tool tab, is the **Processing** tab header with the **Apply** button. To process a loaded image, first select the required methods from the List of available processing methods (Fig. 105); select the active image as the input image with the **Select** button(s). The thumbnail panel at the bottom of the **Processing** tab now shows thumbnails of the selected input images and a preview of the processing result. In the method-specific settings, all the parameters for the active methods can be set, edited or viewed.

When an input image in a processing tool is selected, in addition to the **Preview** panel at the bottom of the **Processing** tab, a new **View** tab – the **Preview** tab - in the Center Screen Area is opened. The **Preview** View tab shows the preview in more detail, while the preview thumbnail is always displayed in the **Processing** main tool tab, even when the view in the Image Display is changed. If in doubt which Image is selected as processing input, always refer to the displayed thumbnails.

The Preview – in the thumbnail as well as in the automatically generated **Preview** View tab in the Center Screen Area – is immediately updated.


When everything is set, click **Apply** on the top of the **Processing** tab and the set processing action will be performed.


All actions in the **Processing** tab automatically generate a new image document if the Processing Output is not explicitly directed to an already existing channel or image.

5.3.2 Maximum Intensity Projection

The **Maximum Intensity Projection** function generates a maximum intensity projection image along the z-, time- or channel dimension of a multidimensional image data set (Fig. 106).

To open the **Maximum Intensity Projection** Processing tool, select it from the list in the **Processing** main tab.

Select the **Input Image** with the  button and choose the dimension along which you want to generate a maximum intensity projection from the **Coordinate** pull down menu (x, time,

channel). Clicking the  button creates the maximum intensity projection in a new image document.

The maximum intensity projection creates an output image each of whose pixels contains the maximum value over all images in the stack at the particular pixel location.



Fig. 106 Maximum Intensity Projection tool

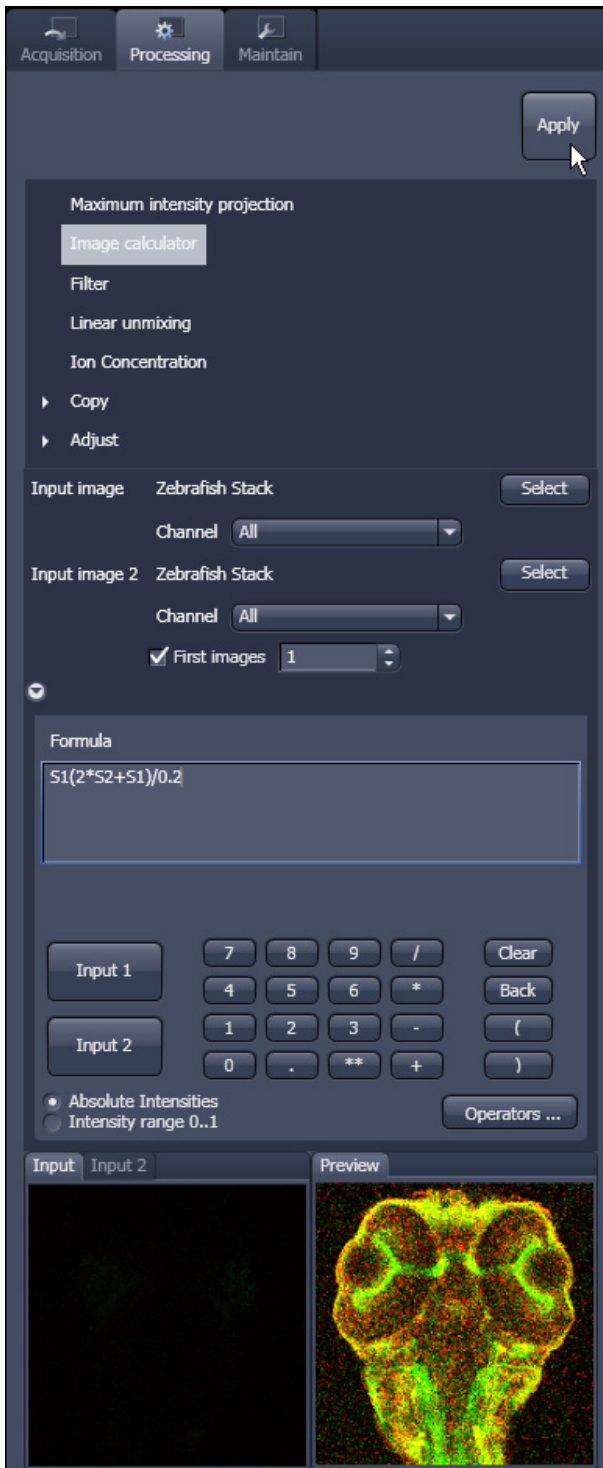


Fig. 107 The Image Calculator window

When choosing images of different data depth the check box next to **Intensity range 1...0** should be marked. This normalizes the image intensity for all images to values between 1 and 0.

5.3.3 Image Calculator

The **Image Calculator** tool provides a calculator-style interface to apply arithmetic operators to the selected image.

- To open the **Image Calculator** tool (Fig. 107), click on the **Image Calculator** in the list of methods in the **Processing** main tool tab.
 - This opens the **Add** window.
 - Click on the **Close** button to quit the **Add** window.

The two **Select** buttons in the selection panel select the active image in the **Image Display** as Input Image and Input Image 2. The Output Image is automatically fed into a new image document. A specific input channel from a multi-channel image or series can be selected with the pull down menu next to the **Select** button.

The **First images 3** option reduces the Input 2 Image series to the selected first frames of a time series. This can be used to normalize a time series to the values of its first image(s).

After loading 2 input (source) images and specifying the input channels, the calculator keyboard allows the definition of an operator or a combination of operators which is represented by a formula in the formula display. The operators will be inserted into the formula at the cursor position. The formula can also be typed in directly. For an overview of the available more advanced operators, please refer to the formula panel that is shown in a pop-up window after clicking the **Operators ...** button (Fig. 107).

By highlighting the selected operator a description of the function of this operator is displayed in the lower part of the operators list (Fig. 108).

All image calculations in this tool work pixel by pixel and start with the upper left pixel regardless of the image size of the two images or image series.

All actions performed in the Image Calculator have immediate effect on the previews. After pressing the **Apply** button on the top of the **Processing** main tab, a new image document with the resulting image is created.

A good example for an application of the Image Calculator is offsetting/normalizing two images or an image series with a reference image to enhance contrast for small changes in intensity:

- Select a time series as **Input 1** and the first frames of this series (or another offset image) as **Input 2**.
- Then type/edit an operator as shown in Fig. 109 that enhances the relative changes in the image with respect to the relatively bright signal level, for example:

$$S1-S2/2 = \text{source 1} - \frac{1}{2} * \text{source 2}.$$

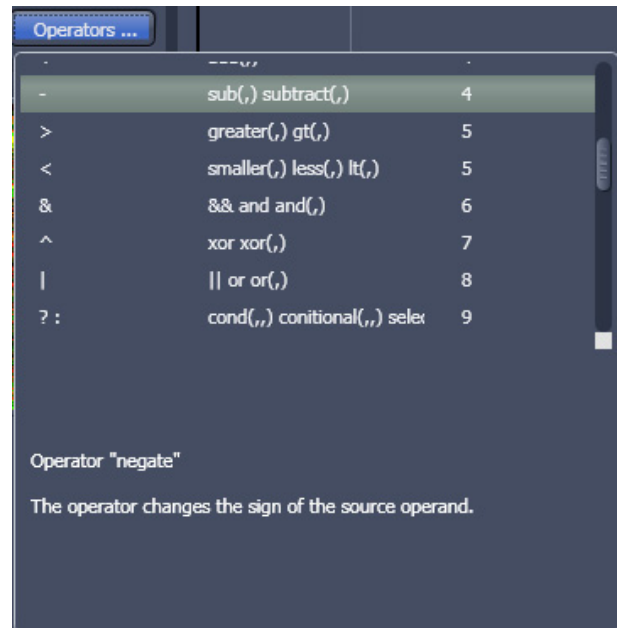


Fig. 108 Operators window

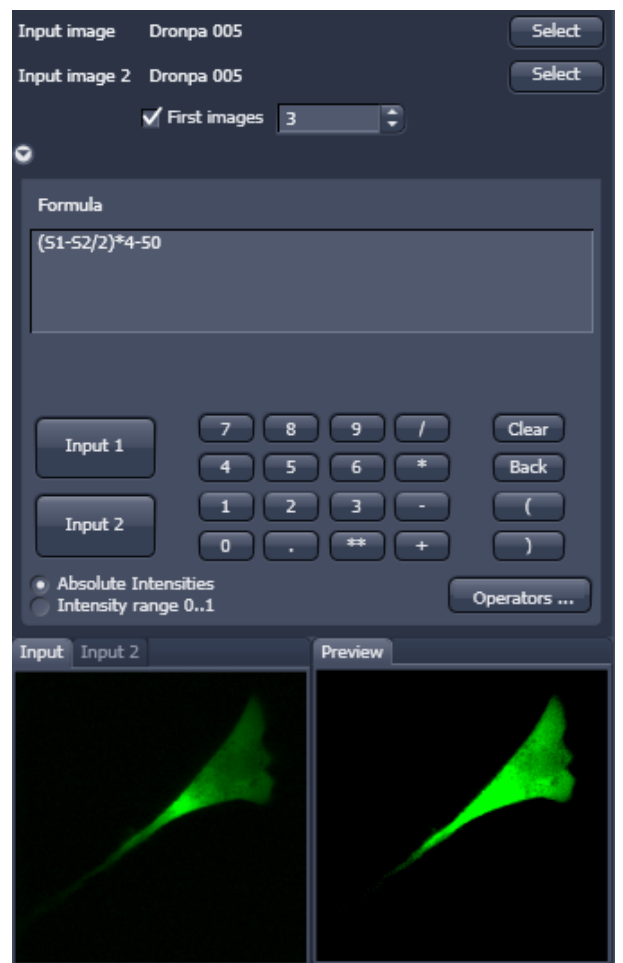


Fig. 109 Image calculation window



Fig. 110 Average window


5.3.4 Average

The **Average** processing function will calculate an image that can be averaged in pixel and time.

- Activate **Average** in the **Processing** tool.

The **Average** menu will appear (Fig. 110). The **Average** processing function will calculate an average image.

- To select an image, press the **Select** button and click into the image in the container. This will be your **Input** image.
- Select how many pixels you want to bin in x-direction, y-direction and time points by setting the respective values in the **X Average Pixels**, **Y Average Pixels**, **Z Average Pixels** and **Time Average Pixels** input boxes, which can be opened by clicking on the arrows.

 Note that **Z-Average Pixels** and **Time Average Pixels** are only available for Z-Stacks and time series. You can either enter a value in, or use the sliders or arrows of the input boxes. If a moving average should be performed, the respective **Moving Average** box must be checked.

In this case consecutive averages comprising the specified number of frames will be computed.

An average output image will be calculated according to the settings and the result presented in the **Preview** window.

The size of the resulting image in **X**, **Y**, **Z** and **T** can be viewed in the **Size of result image** display.

If the **Apply** button is pressed, the averaged image will be opened as a new image in the container.

5.3.5 Filter

The filter function permits the processing of scanned images with a **Median**, **Smooth**, **Sharpen** or **Bandpass** filter.

- To open the **Filter** tool, select it from the list in the **Processing** main tab (Fig. 111).
- Select the **Input Image** with the **Select** button and choose the filter of your choice from the **Type** pull down (Median, Smooth, Sharpen, Band).
- Select the channels you want to process with the **All** **Ch1-T1** **Ch2-T2** buttons. In the filter panel, the filter-specific parameters can be set as described in the following sections.

Median Filter

With the median filter, the gray value of each center pixel is replaced with the median value of the neighboring pixels. The viewed neighbor pixels are defined by a square of a certain size called the kernel. The modified pixel now is the center pixel of this pixel matrix.

The median value is defined as the middle value (not average) of all the gray values sorted in ascending order within a matrix.

Image noise will be reduced by the application of the median filter. The cut-off of regions will slightly blur. Local maxima will be flattened. The dynamic range will be reduced considerably.

The effect of the filter increases with the matrix size. This matrix / kernel size can be set for each dimension with the three sliders in the filter panel or by setting the size in the spin-box on the right hand side of each slider (see Fig. 112). A larger kernel, however, also increases the processing time. Other settings of this filter can not be modified.



Fig. 111 Filter window



Fig. 112 Median filter settings

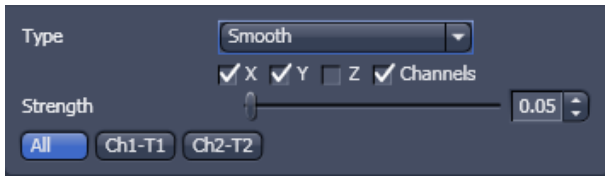


Fig. 113 Smooth filter settings

Smooth Filter

The smooth filter is a lowpass filter with Gaussian characteristic. The gray value of each center pixel is replaced with the weighted average value of the surrounding neighbor pixels. The "neighborhood" is limited by the cut-off in pixels, set by the **Strength** slider. It has an analogous effect as the kernel size (see Fig. 113). If a dimension is processed by this tool is set with the tick boxes. The modified pixel now is the center pixel of the filter matrix.

Image noise will be reduced by the application of the lowpass filter. Sharp edges of regions will blur. Local maxima will be flattened. The dynamic range will be reduced considerably.

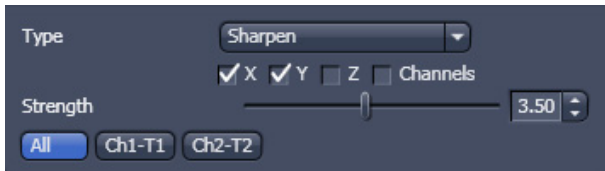


Fig. 114 Sharpen filter settings

Sharpen Filter

With the sharpen filter, the original image is filtered with a lowpass filter first. The result of this filtering is then subtracted from the original image. This will improve image sharpness.

The tick boxes to choose the dimensions as well as the **Strength** slider (see Fig. 114). They are the same as in the **Smooth Filter**.

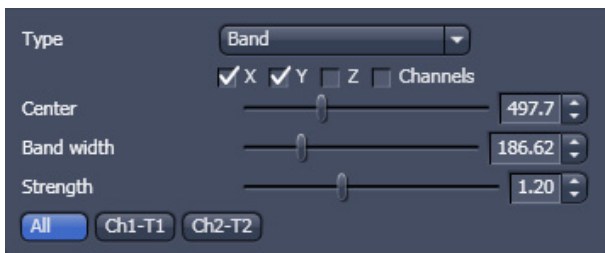


Fig. 115 Band filter settings

Band Filter

With the band filter, the original image is filtered with a "band blocker" filter. It filters out a certain frequency band with position **Center**, width **Band Width** and a steepness of the edges set by **Strength**.

This is particularly useful to remove periodic perturbances in the image.

HDR offline mode

Two images with different exposures can be processed with the offline HDR function (see Section **Frame Mode for LSM** for operation) to increase the grey dynamics and to improve the visibility of weak structures.

5.3.6 Correlation


- Activate **Correlation** in the **Processing** tool. The **Correlation** menu will appear (Fig. 116).

The **Correlation** processing function will display the spatial correlation of an image or image stack.

- To select an image press the **Select** button and click into the image in the container. This will be your **Input** image.

As an output image the correlation image is computed and the result presented in the **Preview** window.

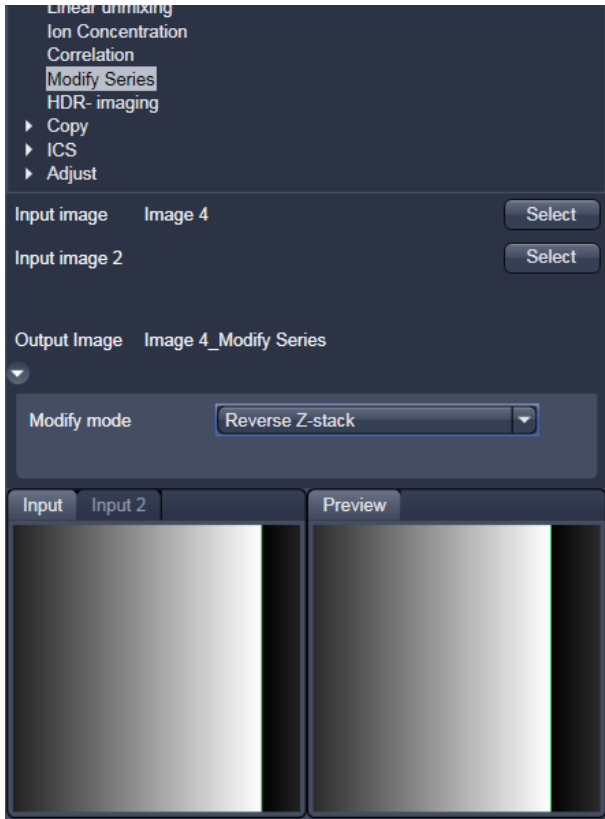
- You can select which kind of correlation you want to perform by activating the **X**, **Y**, **Z** and **Time** check boxes to perform spatial correlations in x, y and z-direction or a temporal correlation.

 Note **X** and **Time** check boxes are only available for Z-Stacks or time series stacks.

- If the **Apply** button is pressed, the correlation image will be opened as a new image in the container.



Fig. 116 Correlation window



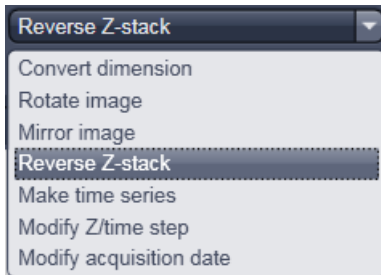
5.3.7 Modify Series

This function allows to modify dimensions of images or image series (Fig. 117).

Depending on the input image (for example **Z-Stack** or **Time Series**) the available modifications vary (Fig. 118). It allows modifying the acquisition date, rotate or mirror the image(s), convert or reverse dimensions or make time series from Z-stacks, tiles scans or images from various positions.

Fig. 117 Modify Series tool

Z-Stack options



Time Series options



Fig. 118 Modification options depending on the selected input image

5.3.8 ICS

- Activate **ICS** in the **Processing** tool by clicking on the arrow.

The **ICS** menu will appear with three sub-processing functions: **Remove structures**, **ICS correlation** and **Map filter** (Fig. 119).

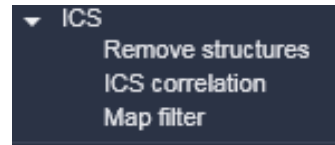


Fig. 119 ICS sub-processing functions

5.3.8.1 Remove Structures

- Activate **Remove structures** in the **ICS** tool. The **Remove structures** menu will appear (Fig. 120).
- To select an image, press the **Select** button and click into the image in the container. This will be your **Input** image.

As an output image an image with the selected average subtracted is computed and the result presented in the **Preview** window.

- If the **Apply** button is pressed, the averaged subtracted image stack will be opened as a new image in the container.

You have four options that can be selected via the **Remove Structures** pull down menu (Fig. 121):

None, **Slowly moving structure**, **Immobile structures (+Stack)** and **Immobile structures (+Plane)**.

If **None** is selected, no average will be subtracted and the original image is kept. If **Slowly moving structure** is activated the **Average frames** input box becomes available. Type in the required number (minimum is 2) or use the slider or arrows for input. The number defines the number of frames that will be averaged and subtracted in a gliding way from the original stack in the following way:

- From a stack of n frames take successive m moving average frames with an overlap of $m-1$ and average these. The outcome is a new stack with $n-m+1$ gliding or moving average frames. Calculate from each of the average frames the overall average of all pixels, which is a scalar.
- Subtract the i -th of the gliding average frame from the $(i-1)+m/2$ original frame and add the i -th scalar. In this way, the first frame to be used from the original stack is $m/2$ and the last $m/2+(n-m+1)$. This creates a new stack of $n-m-1$ frames that is the output image.

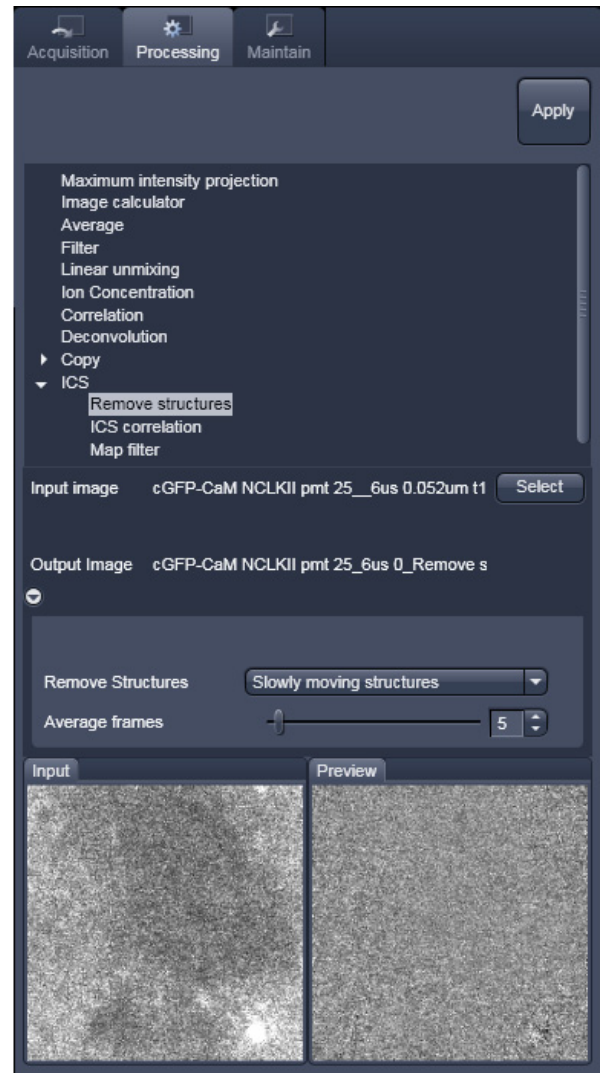


Fig. 120 Remove structures menu

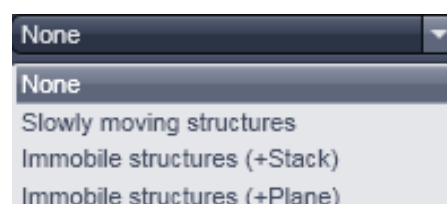


Fig. 121 Remove Structures pull down menu

If **Immobile structures (+Stack)** is selected, the average frame of the stack will be computed and subtracted from each original frame. This creates a new average subtracted stack of the same size. An average value of all pixels from all frames is computed, which is a scalar, and added to each pixel of the single frames of the average subtracted stack to avoid negative numbers. The resulting stack is the output image.

If **Immobile structures (+Plane)** is selected, the average frame of the stack will be computed and subtracted from each original frame. This creates a new average subtracted stack of the same size. Average values of all pixels from each of the original frames is computed, which is a scalar, and added to each pixel of each corresponding single frame of the average subtracted stack to avoid negative numbers. The resulting stack is the output image.



Fig. 122 ICS correlation menu

5.3.8.2 ICS Correlation

- Activate **ICS correlation** in the **ICS** tool. The **ICS correlation** menu will appear (Fig. 122).
- To select an image press the **Select** button and click into the image in the container. This will be your **Input** image.

A correlation image will be computed based on the settings and displayed in the **Preview** window. As an output image an image with the selected average subtracted is computed and the result presented in the **Preview** window.

- The correlation to be computed can be selected from the **Correlation** pull down menu (Fig. 123). For one channel recordings, only **Spatial auto-correlation (S+A)** is available, for a two channel recording in addition **Spatial cross-correlation (S+C)**.

The way of average subtraction can be selected from the **Remove structures** pull down menu (Fig. 124).

- You can select between **None** (no average subtraction), **Slowly moving structures** (subtraction of moving average, the frame size of which can be selected in the **Average frames** input box), **Immobile structures (+Stack)** and **Immobile structures (+Plane)** (subtraction of total average and adding average scalar of all pixels from one frame to each corresponding frame).

The output image will be a correlation stack.

- If the **Merge correlations** check box is ticked, the output will be an average correlation function image computed from the correlation image stack.

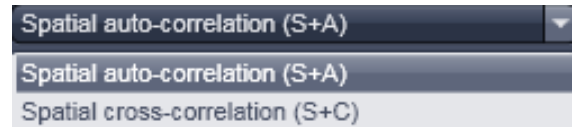


Fig. 123 Correlation pull down menu

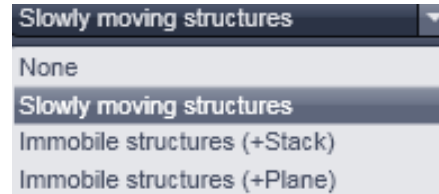


Fig. 124 Remove Structures pull down menu

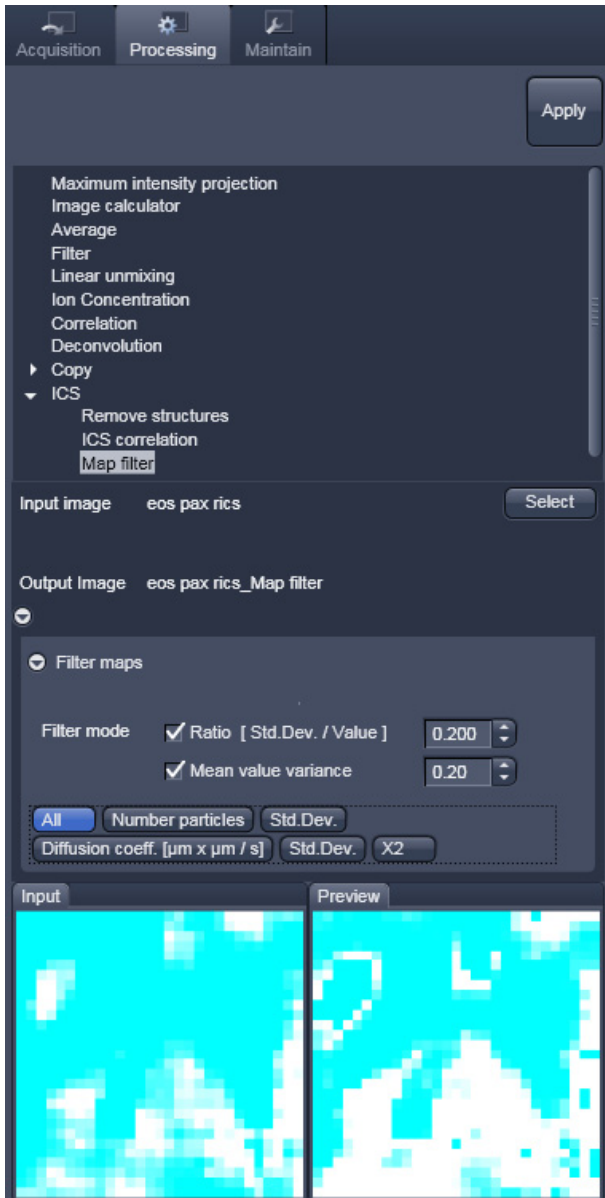



Fig. 125 Map filter menu

5.3.8.3 Map Filter

- Activate **Map filter** in the **ICS** tool. The **Map filter** menu will appear (Fig. 125).
- To select an image map press the **Select** button and click into the image map in the container. This will be your **Input** image map.

As an output image map an image map with the selected filters applied is computed and the result filtered image maps will be opened as a new image maps in the container.


The way of filters to be applied can be selected in the **Filter maps** menu, which can be opened by the arrow, by checking the **Ratio [Std.Dev./value]** and the **Mean value variance** check boxes.

 Note that both filters can be applied together by checking both boxes.

- Thresholds for the filters can be entered in the corresponding input boxes by typing or by using the arrows. Pixels with values exceeding the threshold will be displayed in black and will be discarded for the scaling of the map.

You can define if all maps should be filtered by pressing **All** button in the available filter display area.

- If you want to apply filtering only to a specific map (**Number of particles**, its standard deviation **Std.Dev.**; **Diffusion coeff. [$\mu\text{m} \times \mu\text{m} / \text{s}$]**, its standard deviation **Std.Dev.** and **X²**) the **Filter all maps** box must not be ticked and the corresponding map button pressed, which is indicated by highlighting in blue.

 Note that filtering is never applied to the **X²** map, even if it was selected.

5.3.9 Linear Unmixing

The **Linear Unmixing** processing tool permits to extract the emission of single fluorescence dyes (e.g. GFP only, YFP only etc.) from strongly overlapping multi-fluorescence data acquired in multi-channel images and so-called "Lambda stacks" (see section **Imaging in Lambda Mode**).

Linear Unmixing of spectral information from multi-spectral imaging is an established technology known from remote sensing and satellite imaging. The basics of this increasingly popular image analysis technique in life science microscopy are described in the following resources (selection from a large literature, without claiming completeness):

- Landsford, R., Bearman, G. and Fraser, S.E. / Resolution of multiple green fluorescent protein color variants and dyes using two photon microscopy." / Journal of Biomedical Optics (2001); 6, 311-318.
- Dickinson, M.E., Bearman, G., Tille, S., Landsford and Fraser, S.E. / "Multi-spectral imaging and Linear Unmixing add a whole new dimension to Laser scanning fluorescence microscopy" / Bio Techniques (2001); 31/6, 1272-1278.
- Zimmermann T, Rietdorf J, Pepperkok R. / "Spectral imaging and its applications in live cell microscopy." / FEBS Lett (2003);546:87-92.
- Timo Zimmermann / "Spectral Imaging and Linear Unmixing in Light Microscopy" / Adv Biochem Engin/Biotechnol (2005) 95: 245-265
- or have a look at <http://zeiss-campus.magnet.fsu.edu/> and the respective brochures from Carl Zeiss MicroImaging GmbH

In brief, with the knowledge of the spectral characteristic of individual components of a multi-component sample, even heavily overlapping individual spectral characteristics can be mathematically extracted from experimental multi-channel data. This method is a strictly pixel by pixel image analysis procedure.

Experimentally, fluorescence spectra of mono-labeled samples are acquired and stored in the Spectra Database (see section **Unmixing View**) as an external reference. Then a multi-channel image or Lambda stack of the multi-labeled sample is acquired. Finally, the individual components are mathematically extracted using the information from the reference spectra. Up to ten different reference signals can be fed into the least-square-fit based algorithm to produce a 10-channel multi-fluorescence stack without any partial overlap between the channels.

If no mono-labeled samples are available, the references can be obtained by the following methods:

- a) Interactively by user-selection of regions in the image where only one fluorescence dye is present (only available in the **Unmixing View** tab (see section **Unmixing View**))
- b) Automatically by software analyses of what the individual spectral signatures are. This processing function is called "Multi Channel Unmixing" or "Automatic Component Extraction" (ACE). Note: in some cases, spectrally acquired images are not appropriate for ACE or "Multi Channel Unmixing" and linear unmixing can lead to wrong results.

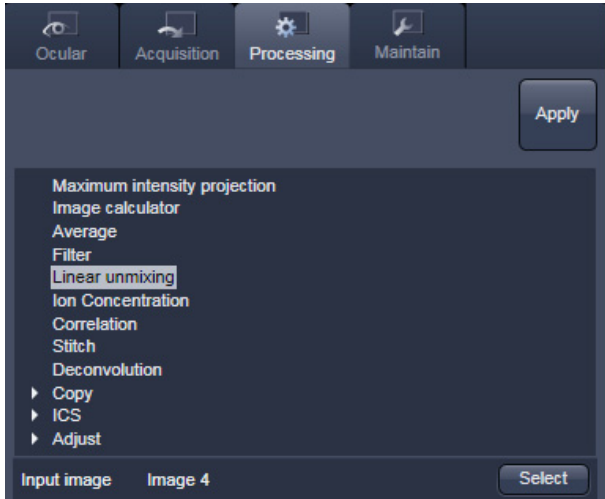


Fig. 126 Linear Unmixing in the Processing tab



Fig. 127 Linear Unmixing panel

- To open the **Linear Unmixing** tool, click on **Linear Unmixing** in the **Processing** tool list in the **Processing** tab (Fig. 126).
- Pressing the **Select** button loads the active image from the **Image Display** and displays it as Input Image. Only Lambda stacks or multi-channel images can be loaded.
- In the **Linear Unmixing** panel (Fig. 127), the number of spectrally distinguishable fluorescent components of the imaged sample can be selected from the **Components** selection box. The number of extractable components can not be higher than the number of acquired channels. The ZEN software is limited to a maximum of 10 components.
- Select the sample-specific fluorescence dye reference spectra from the **Spectra Database** (Fig. 128).
- Assign appropriate colors to the fluorescence channels by clicking on the color flag and choose from the available lookup tables (LUTs) (Fig. 128).
- If no predefined reference spectra exist:
 - Prepare reference samples and create spectra via the **Save to Spectra DB** button in the **Unmixing View** (see section **Unmixing View**).
 - or Use the "Multi Channel Unmixing" functionality described below. (Note: in some cases, spectrally acquired images are not appropriate for "Multi Channel Unmixing" and linear unmixing can lead to wrong results – see discussion below).
- After definition of the required reference spectra click **Apply**.

A new image with the resulting (unmixed) channels will be created (Fig. 129 and Fig. 130).

The following additional settings and functions are available for linear unmixing (see Fig. 127):

Auto scale balances the intensity of the unmixed channels to equal levels.

Display Channel with Residuals generates an additional channel in which the intensity values represent the difference between the acquired spectral data and the fitted linear combination of the reference spectra. In essence, the residual value is the biggest remaining "residual" from the least square fit routine. The residuals are a general measure for how good the fit of the algorithm has performed. The higher the intensity in this additional channel, the worse is the fit of the spectra to the dataset. This shows that either the acquired data is not representing the sample (e.g., when information is lost by pixel saturation) or wrong/insufficient reference spectra have been chosen. In this case, new image acquisition with no overexposed/ saturated pixels is strongly recommended. In the case of wrong reference spectra, choosing/acquisition of different/new reference spectra can be necessary to improve the results.

Background: Select a background spectrum from the list of selected components. This spectrum is then subtracted from the images prior to unmixing. For example: three components selected and one of them marked as background will subtract the selected background from the acquired images and generate a 2-channel unmixed image. For the generation of background spectra refer to the Unmixing View type/Lambda stack – specific view (see section **Unmixing View**). Even small background contributions to the image should be indicated to the unmixing algorithm to ensure best unmixing results.

Weighted unmixing: When this option is checked, spectral channels with high noise do contribute less to the unmixing result. This option includes a statistical analysis of the signal-related (Poisson-) noise and weighs the respective contribution to the fitting of the combination of reference spectra to the experimental data. Note: this option involves a more sophisticated unmixing algorithm and therefore takes longer than the basic unmixing analysis. Weighted unmixing generates improved unmixing results when acquisition channels are not so well balanced but still have a good signal-to-noise ratio.

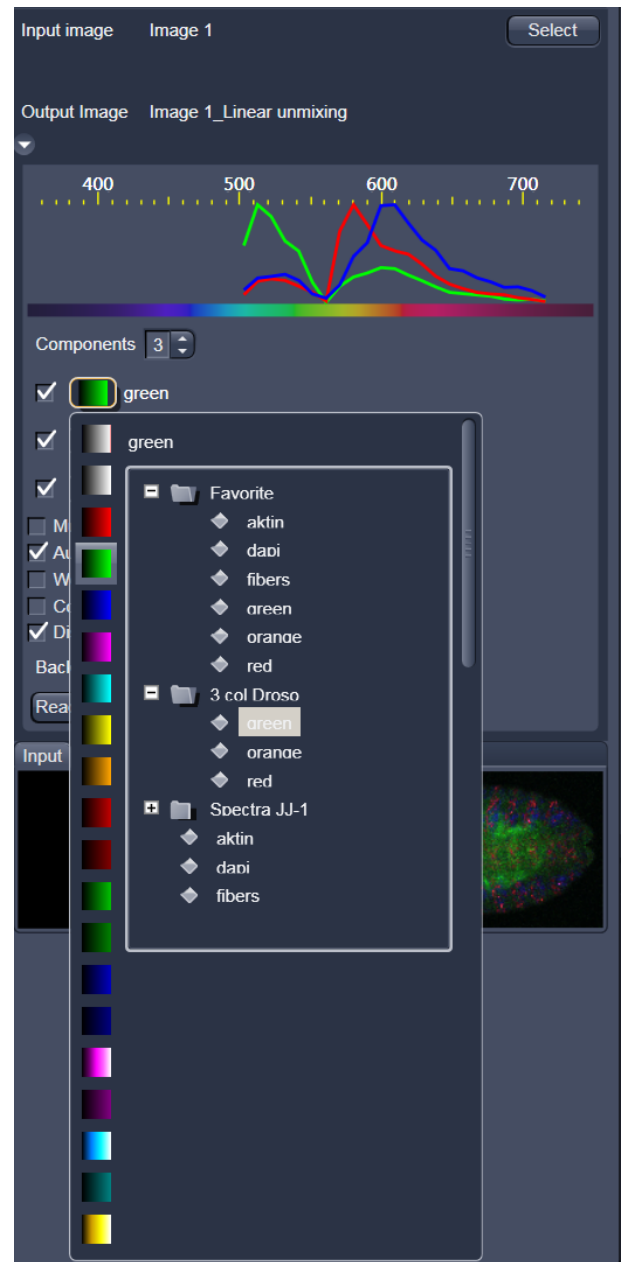




Fig. 128 Linear Unmixing: Spectra and LUT assignment

Display channels with statistical confidence: This option displays an additional channel per unmixed component which shows the relative statistical error in each unmixed component channel. This statistical uncertainty of the pixel intensity in the unmixed channel is calculated based on the (Poisson-) noise of the acquired (input-) channels, the bandwidth and –position and the quality of the reference spectra. The display can be interpreted best when an appropriate false color LUT is chosen. The error is displayed as percentage of unmixed channel pixel intensity. For example: A "confidence value", i.e., pixel intensity of 50 represents a 50% statistical uncertainty of the corresponding intensity in the unmixed channel. The higher the statistical error of the acquired pixel intensity (the shot noise), the higher is the intensity value of this pixel.

Multichannel Unmixing: When this option is chosen the unmixing algorithm is applied to a multi-channel image (up to 10 channels) without the use of reference spectra. See also **Automatic Component Extraction**.

The calculation of residuals and the subtraction of background based on a background spectrum are not available. For heavily overlapping signals this method will yield poor results.

 Avoid saturation of fluorescence signal in the data set to be unmixed. Saturation will generate a high signal in the residual channel. To get the best unmixing results, define an extra background channel, if possible.

 **Reference Spectra** used for **Linear Unmixing** of Lambda stacks processed in the Unmixing View are stored with the resulting image and can be re-loaded in the **Processing** → **Linear Unmixing** tool with the **Read parameters from image** button. This facilitates processing of a series of images or Lambda stacks all with the same parameters / reference spectra.

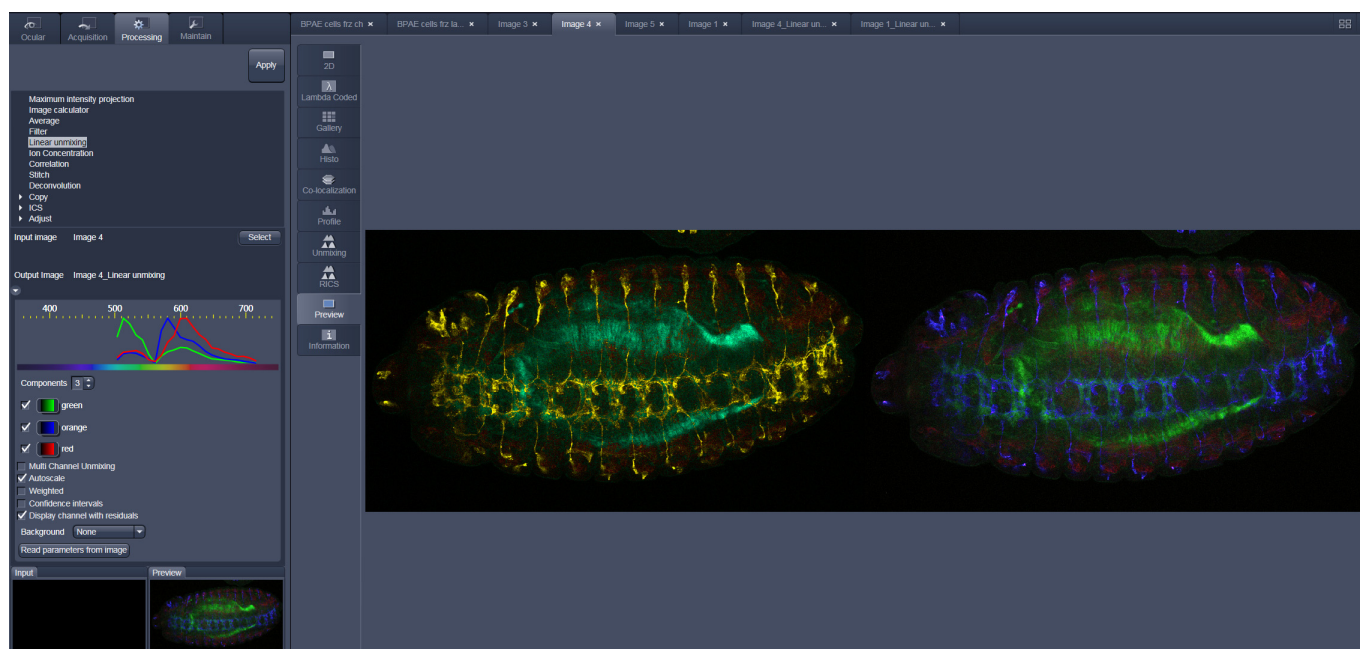


Fig. 129 Image Display window before unmixing in Preview

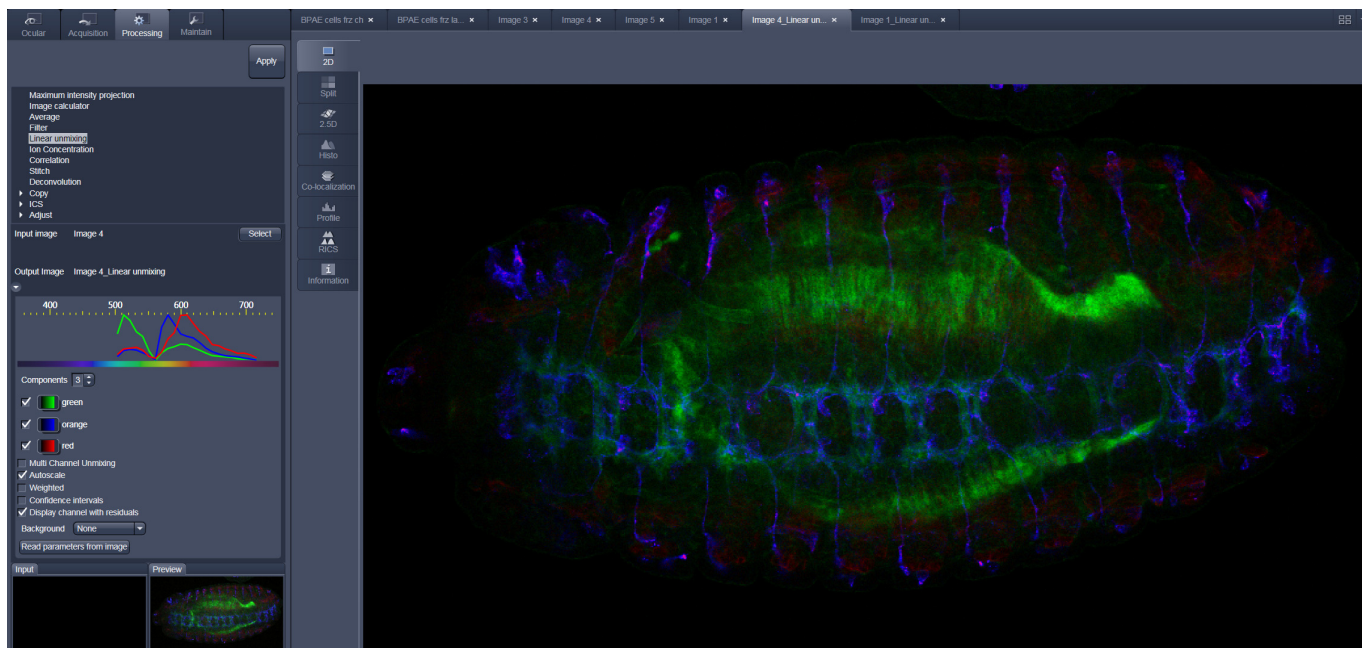


Fig. 130 Image Display window after unmixing

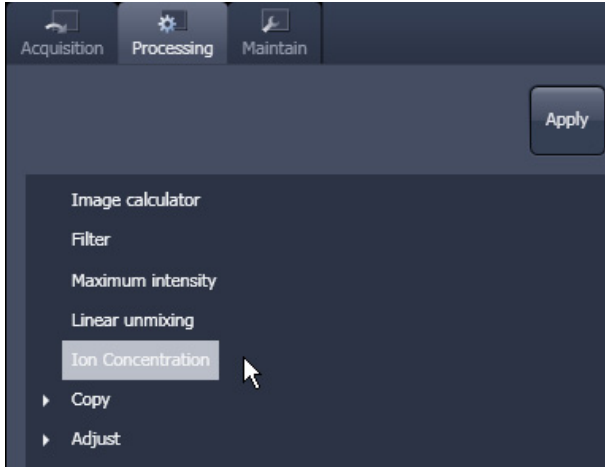


Fig. 131 Ion Concentration in the Processing tab

5.3.10 Ion Concentration

This Processing function permits the calibration of ion concentrations in physiological experiments.

To open the **Ion Concentration** tools click **Ion concentration** (Fig. 131).

The two **Select** buttons select the active image in the **Image Display** as Input Image and Input Image 2 (for background subtraction). The name of the automatically generated Output Image is shown under the name of the Input Images.

At the bottom of the **ion concentration** tool window thumbnails of the input images as well as a preview of the output image are displayed.

After opening the full window by clicking the little arrow under the Output Image description (Fig. 132), the full tool window opens and the following functions are available (Fig. 133).

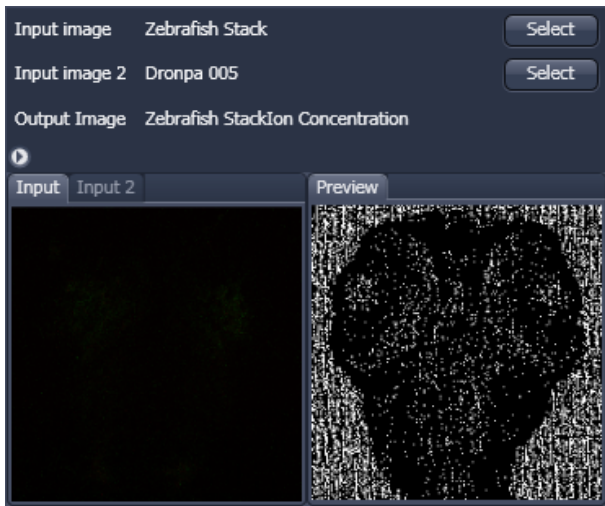


Fig. 132 Ion Concentration tool window

Calibration graph

Opens the display for the resulting calibration curve.

Load ... **Save ...**

To load & save calibration curves from / to files.

buttons

Background (Input 2)

To select Input Image 2 as background image.

tick box

Display minimum concentration 0.10
Display maximum concentration 1.00

Spin boxes to set the Min and Max in the Output Image

Image scaling

Pull down menus for

Dye
Channel 1
Channel 2
Method
Calibration

To set three different calibration options, according to the dyes (single wavelength, vs ratiometric), the calibration method and if the calibration is carried out in vitro/situ. Ch 1 and 2 select the channels from Input Image 1.

From these pull downs, the following combinations of parameters can be chosen:

Dye: **single wavelength** vs. **ratiometric**

Available methods for **single wavelength**: **Titration** or **equation** (both, **in vitro** and **in situ calibration**).

Available methods for **ratiometric** dyes: **Ratio**, **titration**, **equation** and **unmixing**.

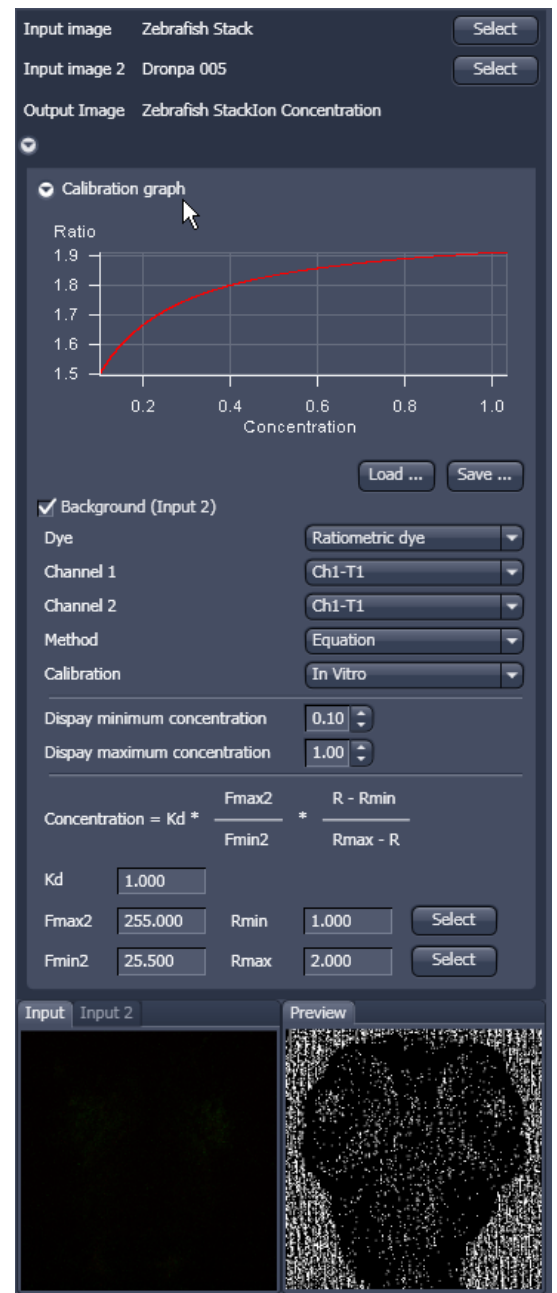


Fig. 133 Fully opened Ion Concentration tool window - Ratiometric dye in equation mode

5.3.10.1 Single Wavelength Dyes – Offline Calibration

- Subtract background/autofluorescence image from raw images to obtain better raw data to start with (Fig. 134).
- Perform equation or titration calibration (compare F with a calibration curve → titration calibration or put F values in calibration formula).

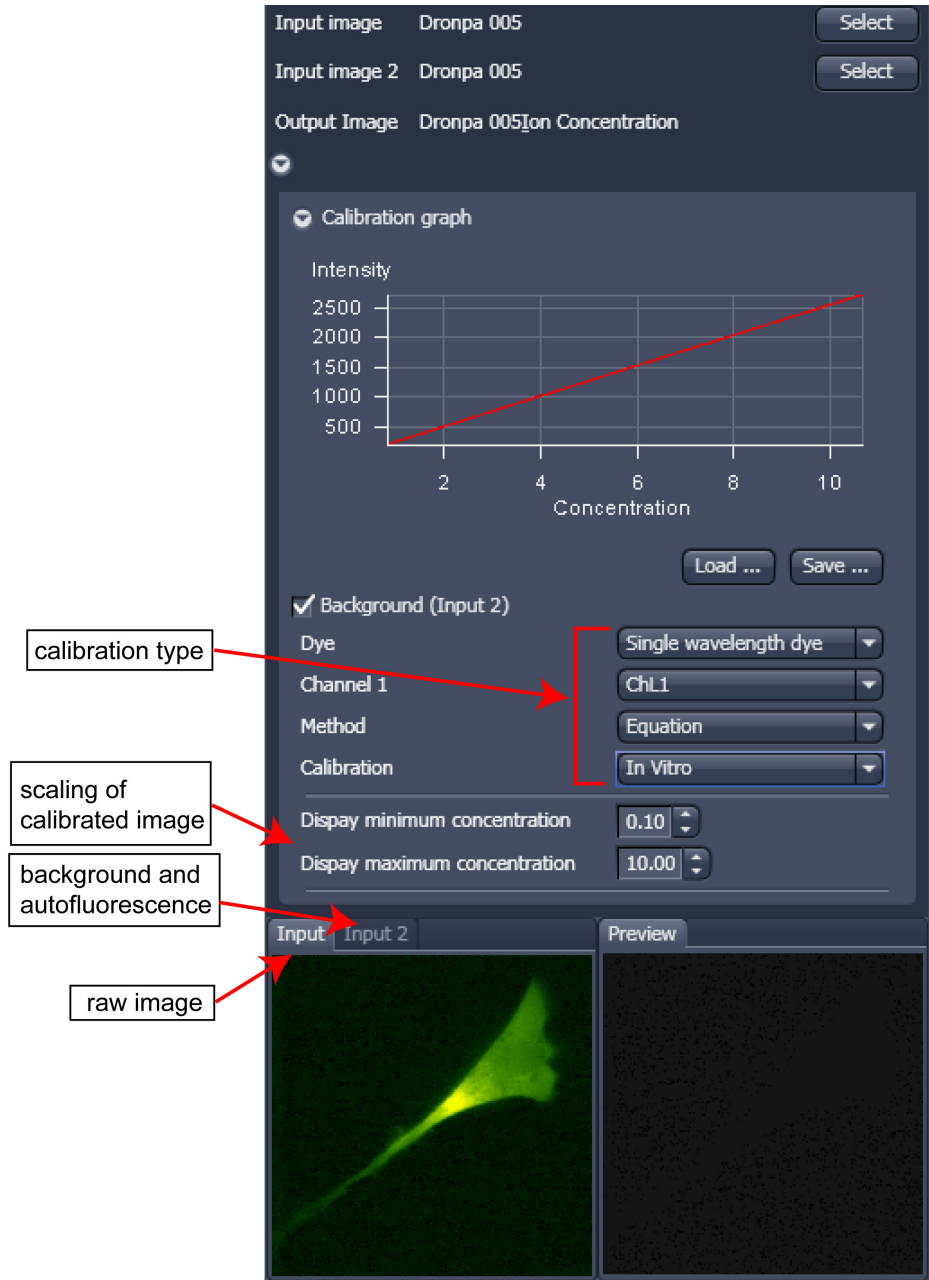


Fig. 134 Ion Concentration panel

5.3.10.2 Ratiometric Dyes

- Fura-2, Indo-, SNARF, Cameleon, Ratiometric Pericam, Phluorin.
- Display fluorescence ratio R over time
- Display fluorescence ratio R corrected for background/autofluorescence over time
- Calculate absolute ion concentrations (pixel by pixel) via titration calibration (known ion concentrations applied to the cells – in situ – or in solutions – in vitro or equation calibration where possible [Fura-2, Indo-, SNARF])
- Calculation of R eliminates artifacts and uncertainties caused by
 - inhomogeneous dye distribution
 - photobleaching
 - may be applied with moving cells.

Ratiometric Dyes - Online Ratio (Fig. 135)

$$R(t_1) = F_1(t_1) / F_2(t_1), R(t_2) = F_1(t_2) / F_2(t_2) \dots$$

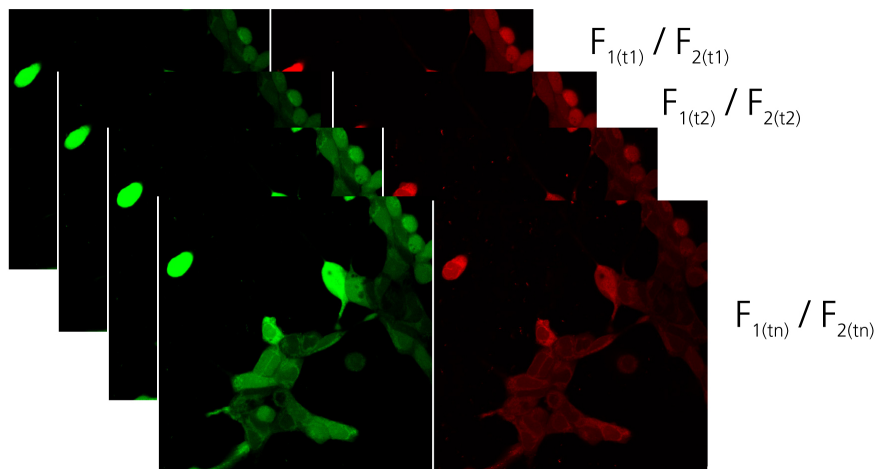


Fig. 135 Ratiometric Dyes – Online ratio

Ratiometric Dyes - Calibration (Fig. 136)

- Subtract background/autofluorescence images from raw images to obtain

$$R_{\text{korr}} [= (F_1 - F_{1\text{Background}}) / (F_2 - F_{2\text{Background}})]$$

when calibration reference is not obtained with the experimental sample (in situ).

- Calculate ratio R.

- Perform equation- or titration calibration (compare R with a calibration curve → titration calibration or put R values in calibration formula).

The figure displays two screenshots of the software interface for ratiometric dye calibration. Both screenshots show the same input parameters: Input image 'Dronpa 005', Input image 2 'Dronpa 005', and Output Image 'Dronpa 005Ion Concentration'. The 'Background (Input 2)' checkbox is checked. The 'Dye' is set to 'Ratiometric dye', and 'Channel 1' and 'Channel 2' are both set to 'ChL1'. The 'Display minimum concentration' is 0.10 and the 'Display maximum concentration' is 10.00.

Left Screenshot (Titration Method):
 The 'Method' is set to 'Titration' and the 'Calibration' is 'In Vitro'. The 'Fit' is set to 'Hill function fit'. The 'Calibration table rows' are set to 4. The calibration table is as follows:

Used	Concentration	Ratio	Select
<input checked="" type="checkbox"/>	5.000	300.000	Select
<input checked="" type="checkbox"/>	3.000	250.000	Select
<input checked="" type="checkbox"/>	2.000	180.000	Select
<input checked="" type="checkbox"/>	1.000	0.000	Select

Right Screenshot (Equation Method):
 The 'Method' is set to 'Equation' and the 'Calibration' is 'In Vitro'. The calibration formula is:

$$\text{Concentration} = Kd * \frac{Fmax2}{Fmin2} * \frac{R - Rmin}{Rmax - R}$$

The parameters are set as follows:

Kd	1.000	Fmin2	25.500	Rmin	1.000	Rmax	2.000
Fmax2	255.000						

Red arrows point from the 'Equation' method section to the 'Input' and 'Input 2' image windows, which are labeled 'calibration type'. The 'Preview' window shows the resulting concentration map.

Fig. 136 Ratiometric Dyes - Calibration

Ratiometric Dyes - Equation Calibration (Gryniewicz) (Fig. 137)

Fura-2, Indo-1,..

K_D (dissociation constant) taken from literature

R_{min} : derived from ion-free state of the dye (e.g. 0 Ca^{2+})

R_{max} : derived from ion-bound state of the dye (e.g. saturated with Ca^{2+})

F_{min2} and F_{max2} are the minimum and maximum fluorescence intensities at wavelength 2

R_{min} , R_{max} , F_{min2} and F_{max2} may be determined in the cells under investigation (in situ) or in solutions (in vitro)

Calibration parameters may be saved and reloaded (*.cal)

Fig. 137 Ion Concentration - Ratiometric dye, Equation Calibration

Options for Calibration Image Selection (Equation- or Titration Calibration)

- Click into image window.
- Select source channel(s).
- Optional background subtraction
- Optional calculation of parameters from overlay region(s)

5.3.11 Stitch

With this function tiled images acquired with Versions of ZEN 2010 and the tiling function can be stitched together in 2D and 3D.

Select a tiled image (or stack) with the select button.

The **correlation threshold** is defining the accuracy with which the algorithm detects similarities in the adjacent image planes.

If a 3D tile scan image has been acquired (Tile Scan combined with Z-Stack) then additional functions for the stitching procedure are available.

Ignore Z Correction will in some cases reveal better results for the 3D stitch. Depending on the image data the last step of the stitch algorithm, which makes a correction of the Z-Stacks in Z looking at the overall image, can lead to unwanted shifts of the stacks in Z. This can be avoided when this option is checked.

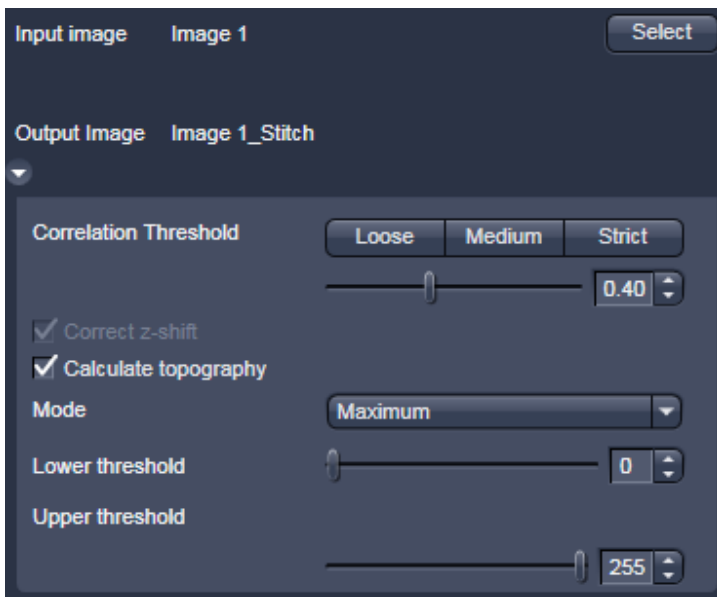


Fig. 138 Stitch function

Calculate Topography provides a topographic image of the 3D stitched image data. This calculation can be done in several modes (see also section **Topography View**).

First / Last maximum

- Select **First maximum** to calculate the topography surface by using the first maximum coming from the top. This mode provides better result for surfaces of semitransparent materials with inclusions of higher reflectivity or transparent multi-layers with subsurface layers of higher signal intensity.
- Select **Last maximum** to calculate the topography surface by using the last maximum coming from the top.

First / Last threshold

- Select **First threshold** to calculate the topography surface by using the first slice coming from the top, where the intensity reaches the value defined by the lower intensity threshold.
- Set the **Threshold** to define the lower and upper intensity thresholds used for calculation of the topography surface. Use of this function is recommended to find the real surface in the case of images with pronounced noise. All image pixels with intensity less or higher than the thresholds set are ignored for the surface calculation. **Correct bleaching** applies a correction factor to the double-exposed pixels. Crossfading is the only method available here and does an interpolation of the brightness values over a number of pixels in X or Y direction. The **Correction Width** in pixels can be adjusted.

5.3.12 Deconvolution

The 3D Deconvolution option is used for the resolution enhancement of fluorescence image stacks.

When a three-dimensional object is reproduced by an optical system the resulting image of the object does not correspond exactly to the object's actual form. The image of the object is "distorted" as it passes through the optical system. In physical terms the actual object is convolved by the optical system's **Point Spread Function (PSF)**.

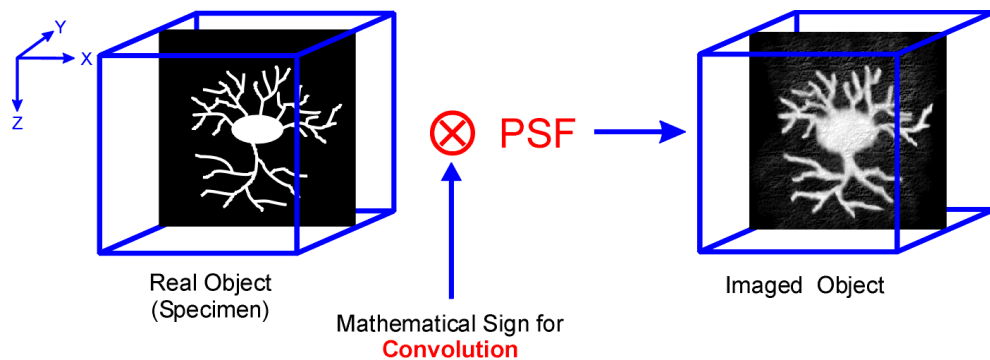


Fig. 139 Point Spread Function (PSF)

The **Point Spread Function** describes how the light of a point object is distorted by the optical system. This "convolution" makes the image appear grainy and structures in the image seem blurred. This effect is most prominent in the axial (Z-)direction as each lens is optimized for the two-dimensional image of the object.

If the PSF is known it is possible to use mathematical algorithms to undo this distortion. The image of the object is deconvolved using the PSF and the actual form is reconstructed:

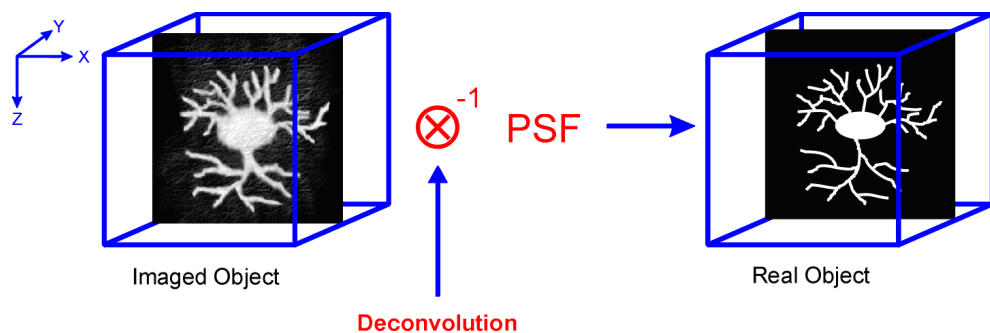


Fig. 140 Point Spread Function (PSF)

The effect of 3D deconvolution can be demonstrated impressively on objects with a known form. As a rule fluorescent beads are used for this purpose. The following figure shows the 3D deconvolution of an image stack with a fluorescent bead with a diameter of 1 μm .

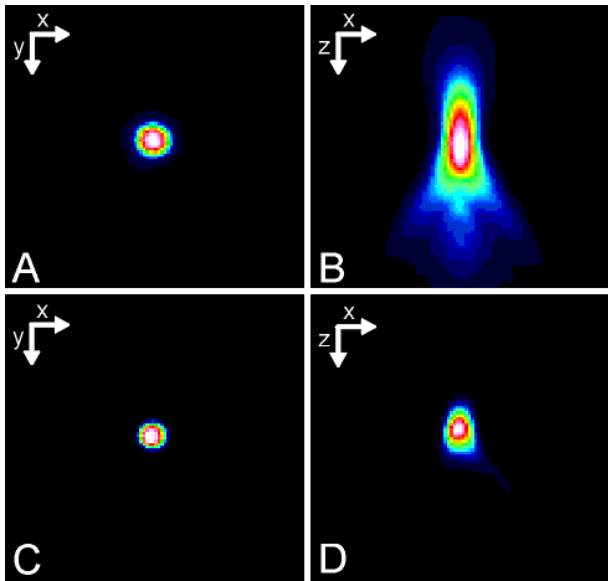


Fig. 141 Image of a fluorescent bead with a diameter of $1\mu\text{m}$ before deconvolution (A,B) and after deconvolution (C,D)

As the resolution of an optical system is significantly lower in the axial direction than in the lateral (X/Y-)direction, the greatest improvement in resolution can be achieved in the Z-direction.

The Z-Stack must meet the following requirements:

- At least two-fold oversampling in xyz (z: half of optimal interval button)
- High signal-to-noise ratio
- Detector gain < 500 V

Calculation is either made for one channel of the opened image which must first be selected accordingly, or for all channels of a stack.

Calculation is started via **Apply** and can be stopped using the **ESC** key, if required.

To open the **Deconvolution** tools click **Deconvolution** (Fig. 142).

5.3.12.1 Methods

The **Method** pull down menu (Fig. 142) permits the selection between the calculation methods **Nearest Neighbour**, **Inverse** and **Iterative**.

(1) Inverse Filter

The regularized inverse filter generally achieves better results than the Nearest Neighbor algorithm. It is well suited to process several image stacks for a pre-selection of images for the use of the iterative high-end methods.

(2) Iterative

The best image quality is achieved using the Constrained Iterative Maximum Likelihood Algorithm. Increasing the resolution in the image, especially in the Z-direction, is only possible with this method. Due to the complex mathematical method, depending on the image size and the PC being used the calculation can take up to several hours.

In the **Inverse** method, the **Restoration Effect** slider permits the noise-to-signal ratio to be selected between the settings **Weak** (low noise) and **Strong** (pronounced noise).

(3) Nearest Neighbor

The Nearest Neighbor method is the simplest and fastest algorithm which in principle corresponds to a 3D sharpness filter.

Activation of the **Auto detect** check box will start a routine for the automatic determination of the noise level in the entire image part of the Z-Stack (not available in the **Nearest Neighbour** method). If **Auto detect** is enabled, the **Restoration Effect** slider is disabled.

The **Iterative** method permits (in addition to the parameters of the **Inverse** method) the maximum number of iterations to be entered between 1 and 200 under **Maximum Iterations** and the **Auto Stop** function to be activated / deactivated. The **Auto Stop** function interrupts the calculation depending on the set image improvement (delta between last but one and last cycle in %), no matter whether the value under **Maximum Iterations** has been achieved or not.

The **Nearest Neighbour** method permits entry of the **Number of Neighbours** and the **Sharpness in Focus** value in addition to the **Restoration Effect**.

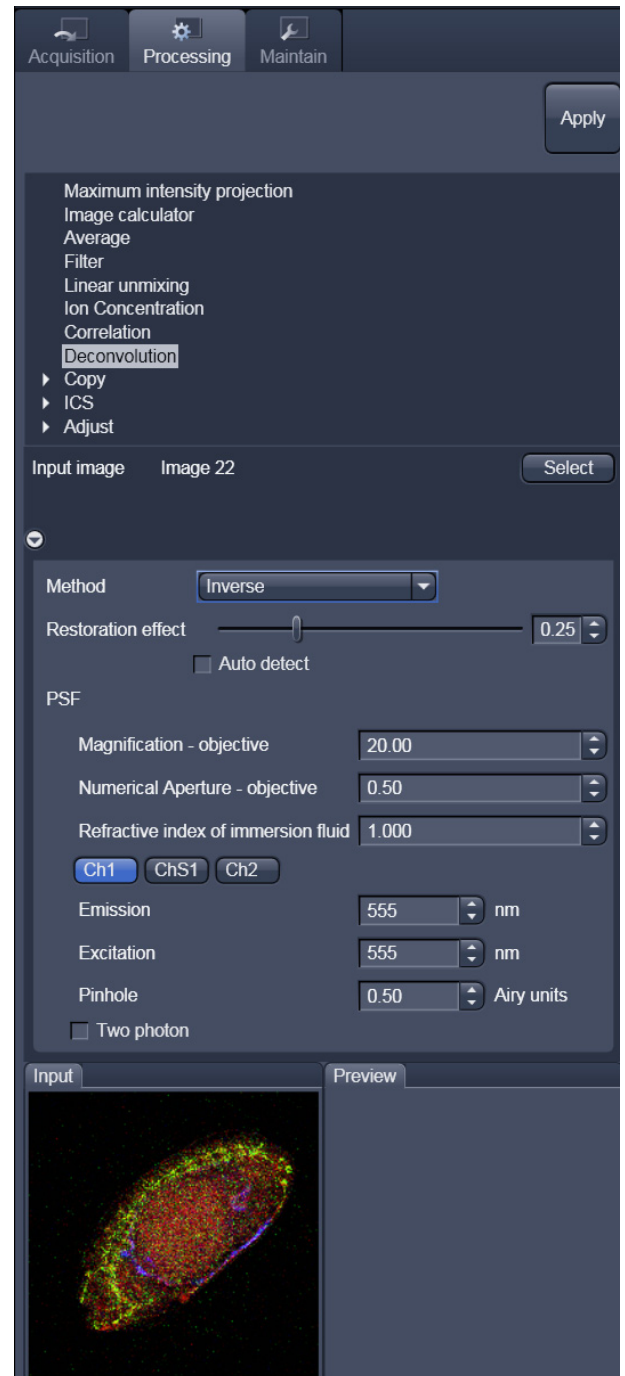


Fig. 142 Deconvolution window

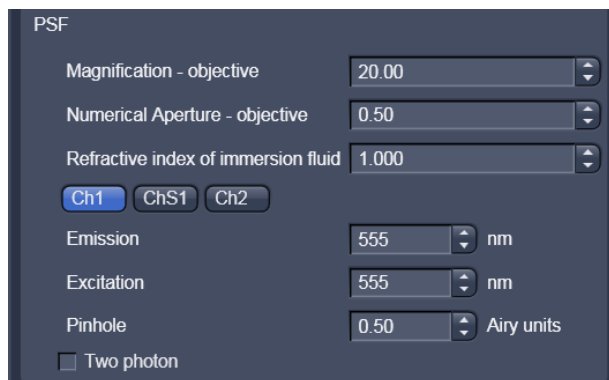


Fig. 143 PSF data input fields

5.3.12.2 PSF Tab

In the **PSF** settings section of the **Deconvolution** tool, a theoretical point spread function (PSF) is calculated from the systems settings (objective data, wavelengths, pinhole diameter).

For wavelengths above 700 nm, the **Two photon** button is automatically activated.

The displayed values are always taken from the hardware parameters / images meta data, but can be edited subsequently for simulation purposes.

5.3.13 Copy


The **Copy** function provides means to copy or duplicate images.

Copy Channel (Fig. 144) produces a copy of the selected image.

The first **Select** button in the selection panel selects the active image in the **Image Display** as Input Image. The **Channel All** selection pull down specifies which channel to copy.

The second **Select** button is used to choose a destination image if the copied channel is to be added to an existing image document. In the second **Channel New image 8-bit** pull down menu, the destination channel is specified – or a new image document can be chosen as destination.

Apply starts the copy process.

 For Z-Stacks or Time Series, the entire series of the selected channel is copied.

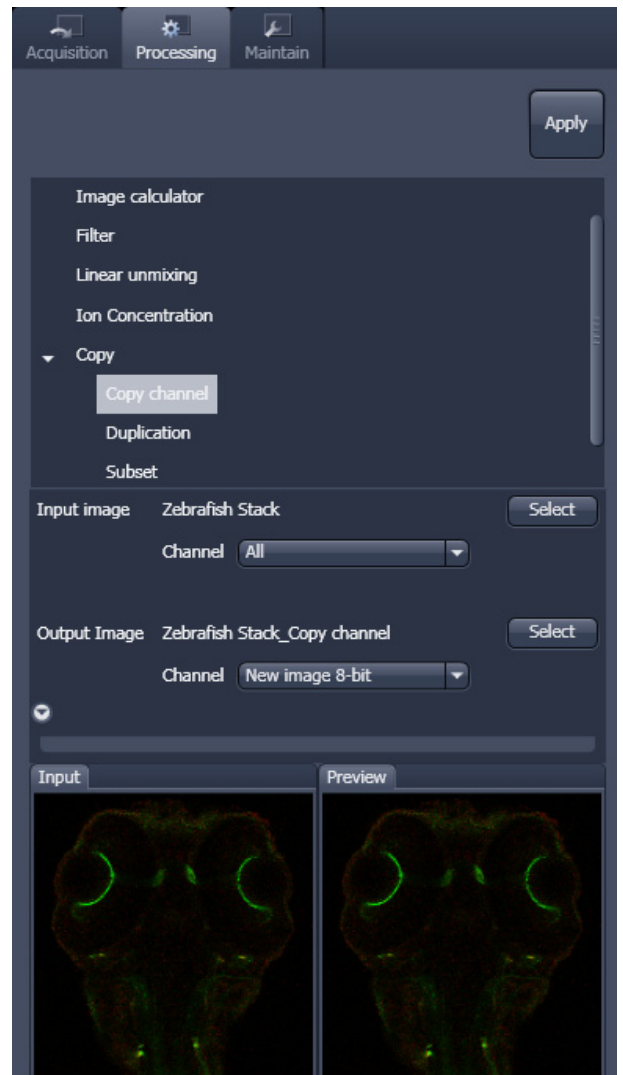


Fig. 144 Copy window

Duplication

Duplication creates a new image document which is a duplicate of the selected input image.

Delete Image

Single images or series of images can be deleted from the selected image series (input image) acquired as time series or Z-Stacks or combinations of those.

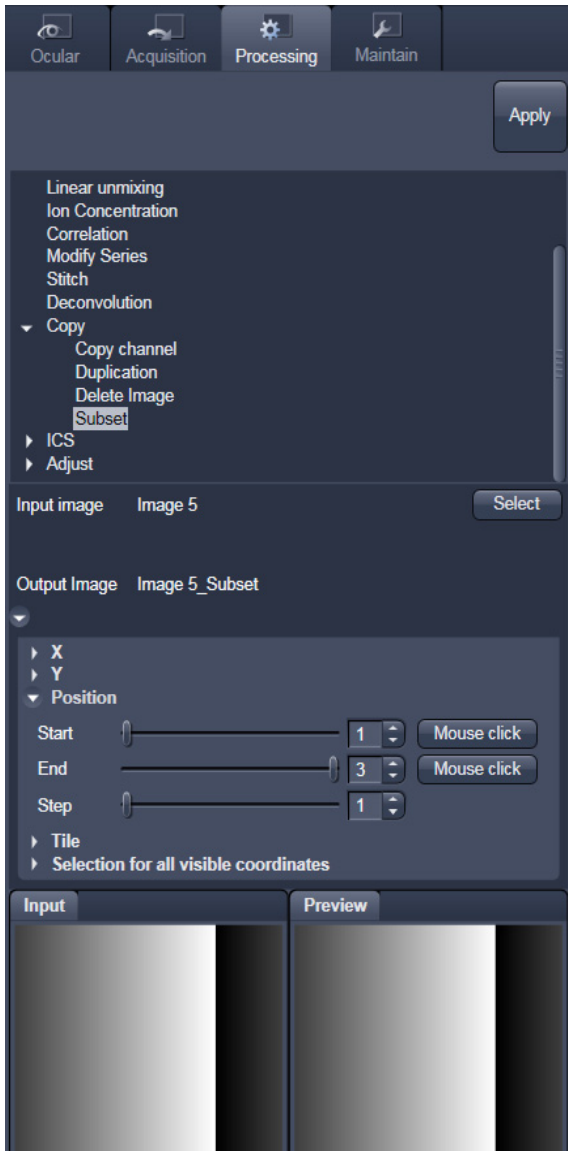


Fig. 145 Subset tool with loaded Multiposition Tile-Scan

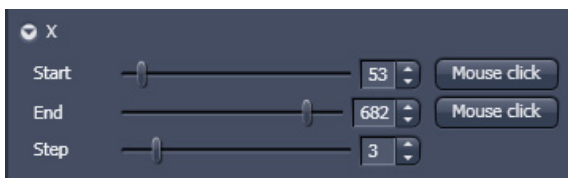


Fig. 146 Subset panel for the x coordinate

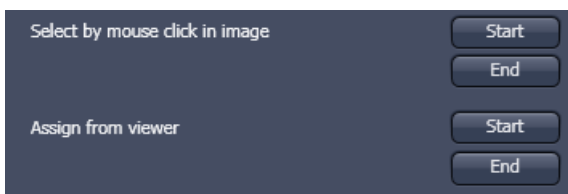


Fig. 147 Subset panel for "visible"

Subset

The **Subset** function is a set of tools to truncate a multidimensional data set in all available coordinates to the desired size (Fig. 145).

The **Select** button selects the active image in the **Image Display** as the Input Image to be processed.

In the tool-specific settings panel, the parameters for the interpolation procedure are set.

Opening for example the **x-subset** panel (Fig. 146) brings up three sliders to set the **Start** and **End** coordinates of the new data set.

Mouse click Selects the respective coordinate by clicking in the original image in the **Preview View** in the image display area (Center Screen Area). The **Step** coordinate determines how many data points in the respective dimension are dropped out.

For example: setting **Step** to 3 takes 1 and drops 2 pixels along the respective dimension, reducing the data to 1/3. The scaling is calculated to stay correct in the resulting image.

This subset-panels are available for all coordinates of the selected image (x, y, z, t, channel, position and tile). The panel **Selection for all visible coordinates** is shown in Fig. 147. It always applies only to those coordinates with the subset-panel (above) open.

The **Select by mouse click in image** option allows to click in the Image Display and the respective coordinates are set (if displayed in the image: x, y, tile in the 2D view, z and position in the gallery view, channel in the split view, etc).

The assign from viewer selects the coordinate from the slider in the **Dimensions View Options** control block.

5.3.14 Adjust

5.3.14.1 Burn in Brightness and Contrast

The **Burn in brightness and contrast** function creates a new image document in which the current brightness and contrast settings from the **Display View Options** control block (see section **Center Screen Area / Image Containers - Display and Image Analysis**) are permanently written to the image file (Fig. 148).

The **Select** button selects the active image in the **Image Display** as the Input Image to be processed.

- After adjusting the brightness and contrast in the **Display View Options** control block, click **Apply** to create the new image document with the burnt in contrast and brightness settings.

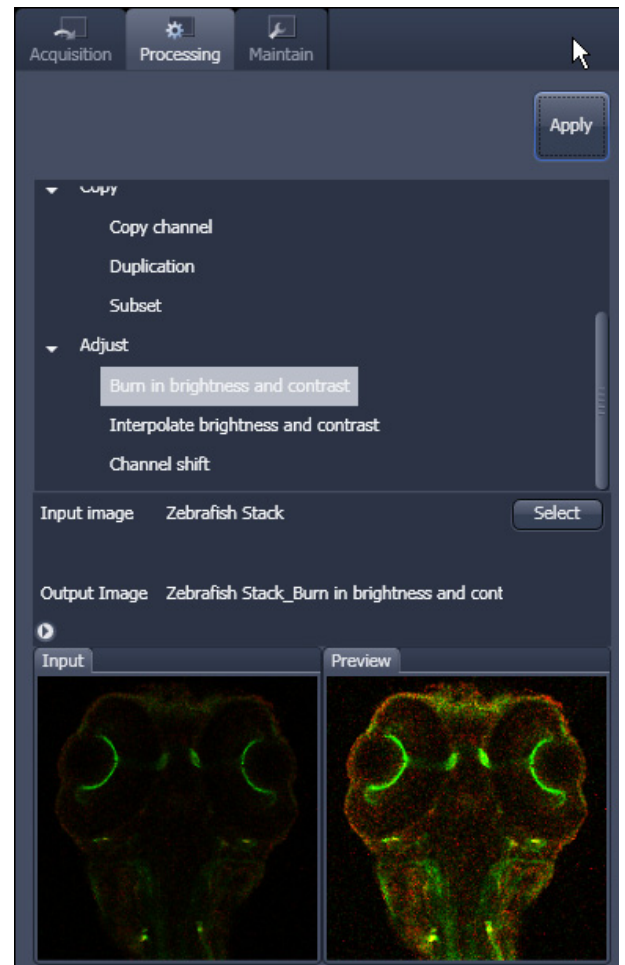


Fig. 148 Burn in Brightness and contrast tool

5.3.14.2 Interpolate Brightness and Contrast

This function permits a continuous contrast and brightness adjustment in a Z-Stack or Z-Stacks over time by interpolation between the starting and end values of the respective image series. This permits a post-acquisition compensation of signal loss in, for example, thick tissue imaging where excitation and detection efficiency decrease significantly. Interpolation can be defined for the entire image or only for individual channels. In addition, a set of coordinates for which intensities are kept fixed during the interpolation calculation can be defined (Fig. 149).

The **Select** button selects the active image in the **Image Display** as the Input Image to be processed.

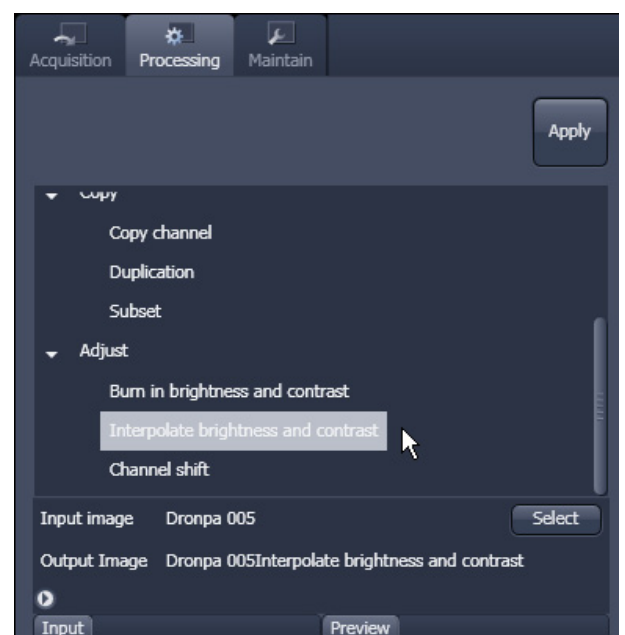


Fig. 149 Interpolate brightness and contrast tool

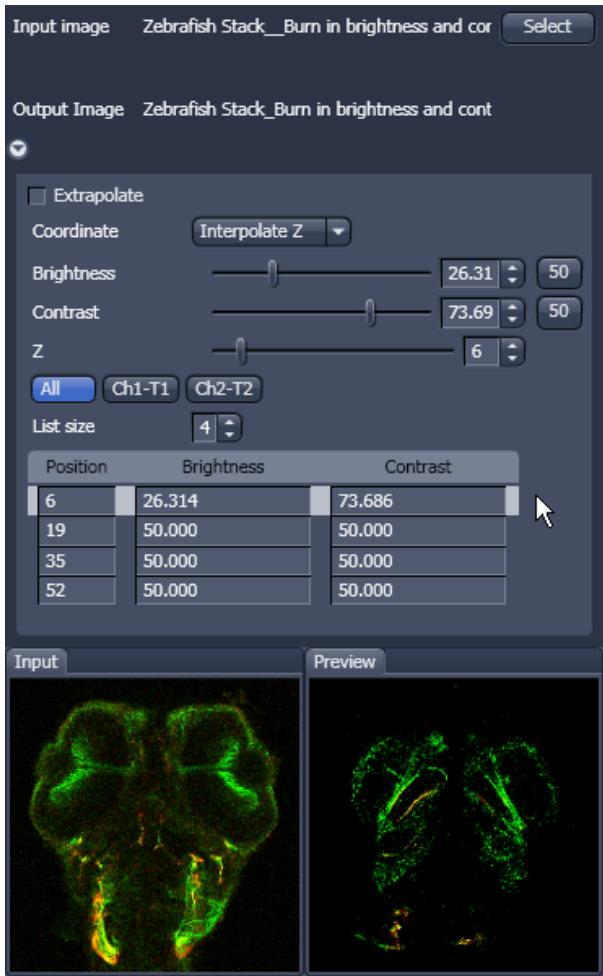



Fig. 150 Interpolation brightness and contrast tool with loaded Z-Stack

In the **Interpolation** panel (Fig. 150) the parameters for the interpolation procedure are set.


- In the **Coordinate** pull down, select the dimension for the interpolation. Depending on the image data type, x, y, z and time are the possible options.
- Use the **List size** spin box to set the number of fixed data points. The table in the **Interpolation** panel will be extended to the selected number of rows.
- Highlight a row of your choice by clicking on it. Then use the **Brightness, Contrast and Z** (or t) slider to set the values for this fixed data point. The numbers in the table will be updated according to the slider position. Then highlight the next row, set the parameters and keep setting the fixed data points for all rows.
- Use the available channel buttons **All**, **Ch1-T1**, **Ch2-T2** to select the channel for interpolation or click on the **All** button if the entire image is to be interpolated.
- Having set the parameters, click on the **Apply** button. Interpolation will be performed in a new **Image Display** window.
- The newly created image (series) can be stored using the **Save As** function.

 If you de-activate the **Extrapolate** check box, only the slices lying between the first and last fixed data point (table rows) will be taken into account for interpolation. Otherwise, brightness and contrast will also be changed for the other slices.

5.3.14.3 Channel Shift

Channel Shift is used to produce a congruent image with relation to the pixels of the various channels (Fig. 151).

This pixel correction function is particularly important in UV applications.

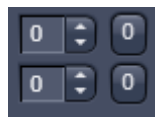
 This is a manipulation of your data that has to be considered very carefully when co-localization analysis is part of your experiment.

The **Select** button selects the active image in the **Image Display** as Input Image.

The image has to be a multi-channel image. In the

- Select the channels you want shift by ticking the **Ch1** or **Ch2** check box: Ch1-T1 Ch2-T2

- And use the sliders



or the spin-boxes to select the pixel shift in the horizontal and vertical direction. Clicking the Zero next to the spin-boxes resets the shift to the original position.

- A preview is automatically generated at the bottom of the **Channel Shift** tool in the **Processing** tab of the Left Tool Area and at the same time. A large preview is shown in the **Preview** view tab in the Image display in the Center Screen Area.

- Click on the **Apply** button to generate a new image with the set pixel shift.

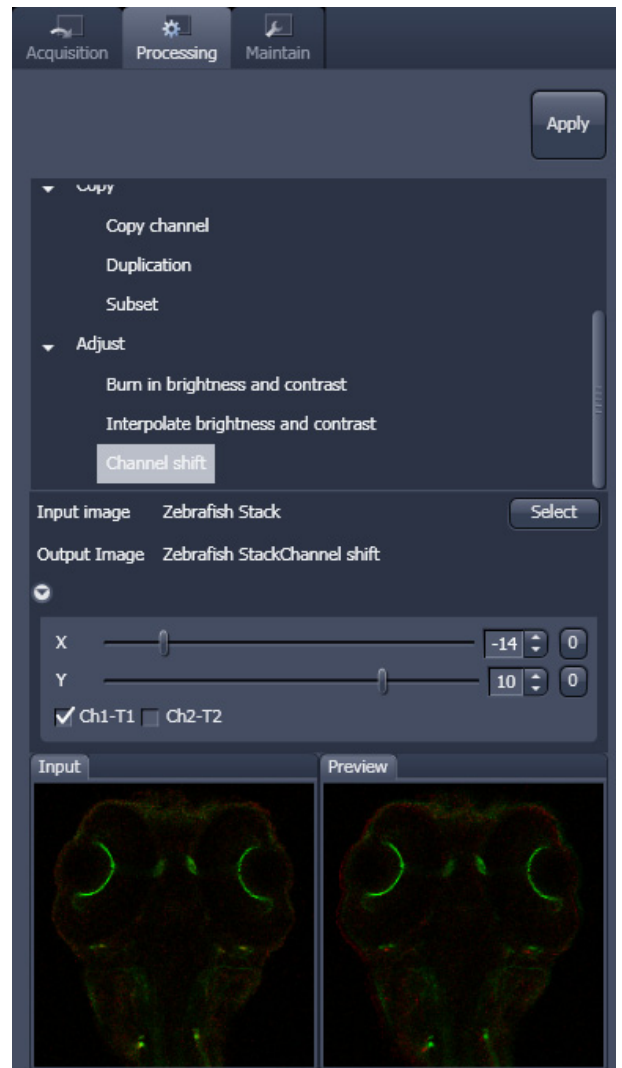


Fig. 151 Channel Shift window

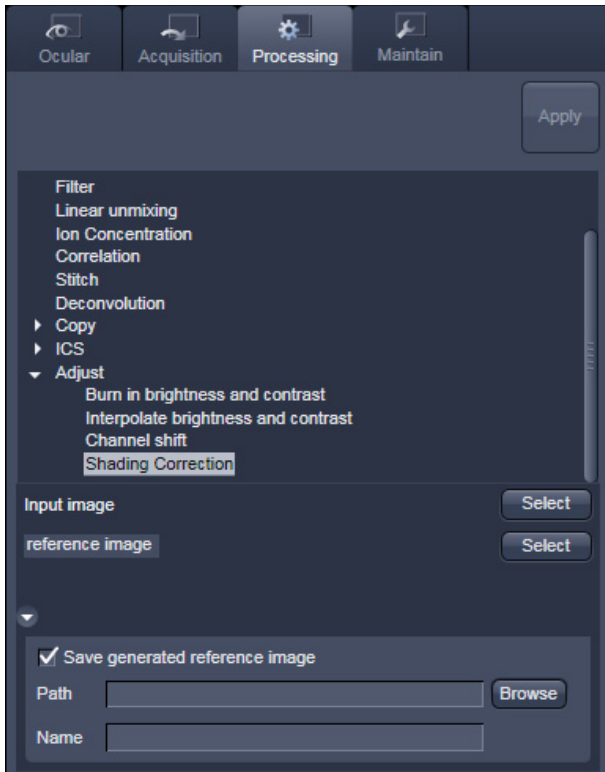


Fig. 152 Shading Correction interface

5.3.14.4 Shading Correction

Shading Correction is a tool to manipulate images which are unevenly illuminated over the field of view. This works with single images, time series, Z-Stacks or tiled images. Click on Shading correction to open the interface for using that function.

Select the image (or image series, tiled image or Z-Stack) for which the shading correction should be applied by clicking **Select** next to **Input image**. When clicking **Apply** the system calculates a reference image from the input image(s) which is used to correct the input image(s). The corrected image is displayed in the center area screen.

In addition the calculated **reference image** can be stored and used for further shading corrections of other images. Therefore the check box in the lower part of the tool box must be checked. Specify the folder where the image should be stored in the text box next to **Path**. **Browse** opens the windows folders from which you can select. A suggestion for the name of the image is made based on the original name of the image. Change this if needed.

This reference image can then be loaded and selected as reference image for the shading correction of subsequent images, which are then processed much quicker.

The reference image must be taken from an image that was acquired with identical settings for objective, zoom, image format and orientation.

5.4 Maintain Tab

The **Maintain** tool group on the **Maintain** tab provides functions to adjust hardware components of the system.

5.4.1 Adjust Pinhole and Collimator

This function permits pinholes and collimators to be optimally aligned and adjusted to the used beam path. The function can be called up in the **Maintain** panel in the **Adjust Pinhole and Collimator** tool of the **Maintain** tool group (see Fig. 153).

The position of the pinhole (X-Y-Z-coordinates) in relation to the detector makes a major contribution to image optimization.

In all existing standard configurations, the pinholes have already been adjusted at the factory. These settings are taken over for active operation when a standard configuration is loaded.

If you want to create a setting that differs from the standard configurations, adjust the pinhole as follows.

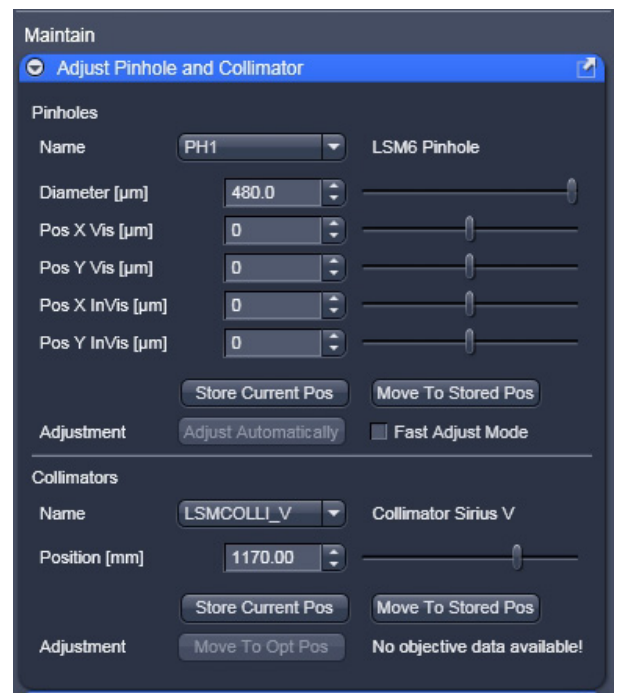


Fig. 153 Adjust Pinhole and Collimator tool

5.4.1.1 Pinholes Section Panel

The **Pinholes Section** panel has the following options:

Description field:	Display of the relevant active channel.
Diameter [µm] slider	Setting of diameter, X-, Y- and Z-position of the pinhole in relation to the beam path (Z-position can be set only for PH1) using the slider or arrow buttons
Position X Vis [µm] slider	
Position Y Vis [µm] slider	Status display for setting procedure: green for ready and red for busy.
Position X InVis [µm] slider	
Position Y InVis [µm] slider:	
Stored Pos button:	Pinhole setting is reset to the position last stored.
Adjustment: Adjust Automatically button:	Automatic pinhole adjustment (not available in some systems).
Fast Adjust Mode check box:	If this check box is activated, the pinhole adjustment is only performed in a limited area. Used for readjustment (not available in some systems).

No further software function can be activated and executed while automatic pinhole adjustment is running.

5.4.1.2 Collimators Section Panel

The **Collimators Section** panel has the following options (Fig. 154):

- Name** drop down menu Selection of the collimator (IR / VIS or UV / VIS) to be adjusted via **the drop down menu**.
- Description** field: Display of the relevant active Collimator
- Position [mm]** field: Setting of collimator position using the slider or arrow buttons; the display to the left of the slider indicates the current position
status display for setting procedure: green for ready and red for busy.
- Current Position** button: Stores the current collimator position.
- Stored Pos** button: Sets the collimator to the stored value.
- Adjustment Move to Opt Pos** button: Starts the automatic collimator adjustment. Available for some objectives.

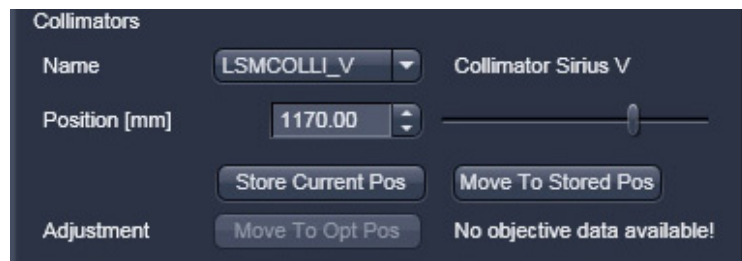


Fig. 154 Collimator section panel

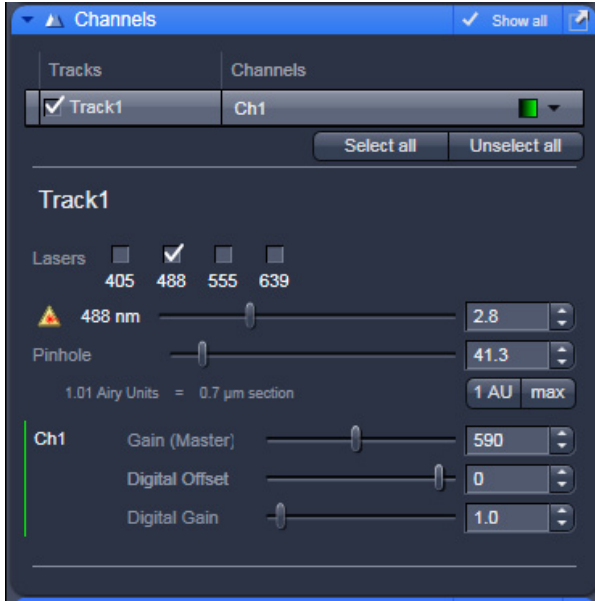


Fig. 155 Channels tool

5.4.1.3 How to Adjust the Pinhole

Adjustment of pinholes can be performed manually or automatically.

Temporary optimization of the adjustment:

The position of the pinhole relative to the detector in terms of X-Y-Z coordinates contributes substantially to image optimization.

Requirements to make the influence of pinhole position changes on image brightness immediately visible:

- The image must be scanned by the continuous scan method.
- Select a fast scanning speed.
- Measurement with Average Number 1 only (no averaging of several measurements).
- On the **Channels** tool in the LSM **Online Acquisition** tool group select the pinhole diameter so as to have the best possible image contrast (see Fig. 155).

- Open the **Adjust Pinhole and Collimator** tool in the **Maintain** tool group in the **Maintain** panel.
- Select the pinhole to be adjusted from the **Name** list box.
- Use the **Diameter** slider to set the smallest possible size which produces a good, high-contrast image.
 - This setting changes the pinhole diameter.
 - The **Optimal Interval** box of the **Optimize Sectioning and Step** submenu of the **Z-Stack** tool in **Show all** mode within the **Multidimensional Acquisition** tool group simultaneously displays the depth resolution corresponding to the pinhole diameter (see Fig. 156).



Image optimization can be effected with the **Range Indicator** or in the **Line-Scan** mode.

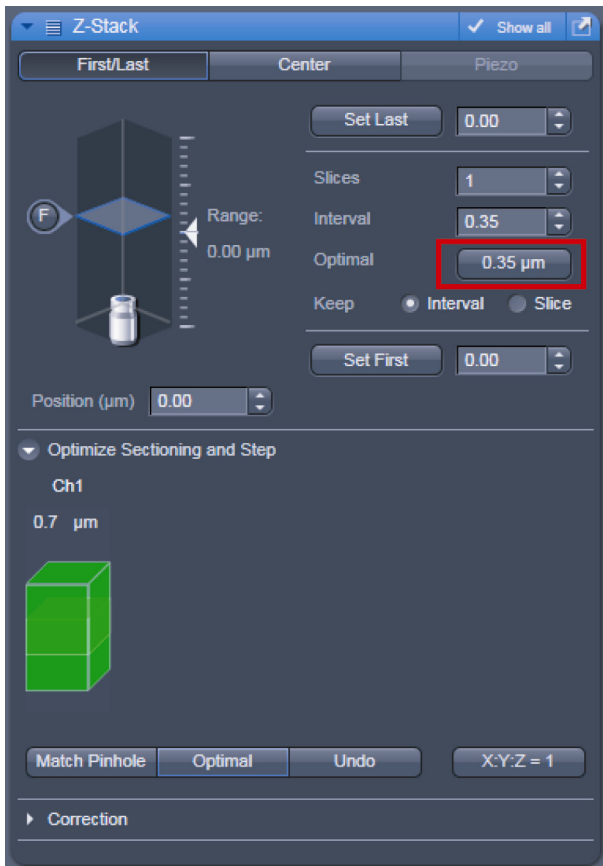


Fig. 156 Z-Stack tool

- Click the LSM **Continuous** action button to start a continuous scan. Optimize the pinhole position in X, Y and Z (Z only for PH1) relative to the PMT using the **Position X [µm]**, **Position Y [µm]** and **Position Z [µm]** sliders to maximum image brightness (see Fig. 157).
- Moving the **Position [mm]** slider in the **Collimator** panel allows the collimator to be adjusted to maximum image brightness. Optimum collimator adjustment obtained in this way can be stored by clicking on the **Current Pos** button. The Collimator is pre-set from the factory and care should be exerted by changing its position.
- Click the **Stop** action button to stop the continuous scan.

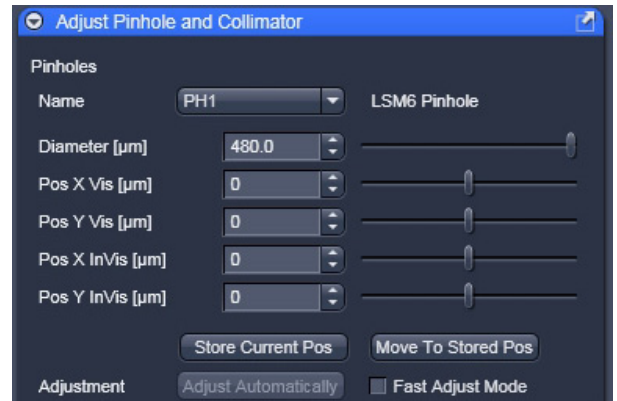



Fig. 157 Manual pinhole adjustment

Automatic pinhole adjustment:

The automatic adjustment allows the LSM 710 and LSM 780 systems pinholes to be used with any combination of beam splitters and more than one active channel.

 Please do not make any program manipulations while the automatic pinhole adjustment is running (status display is red - busy).

- Click on the **Adjustment Adjust Automatically** button.
 - The **Requirements for Adjustment** window will then appear.
- Meet the requirements listed in the **Requirements for Adjustment** window (Fig. 158). Press **Cancel** to abort the automatic pinhole adjustment. Press the **OK** button to proceed.
 - Pinhole adjustment will then run automatically and the Scan window will appear (see Fig. 159). The adjusting procedure takes approx. 3 min.
 - The determined data are stored automatically and will be available for all further examinations using the same configuration.

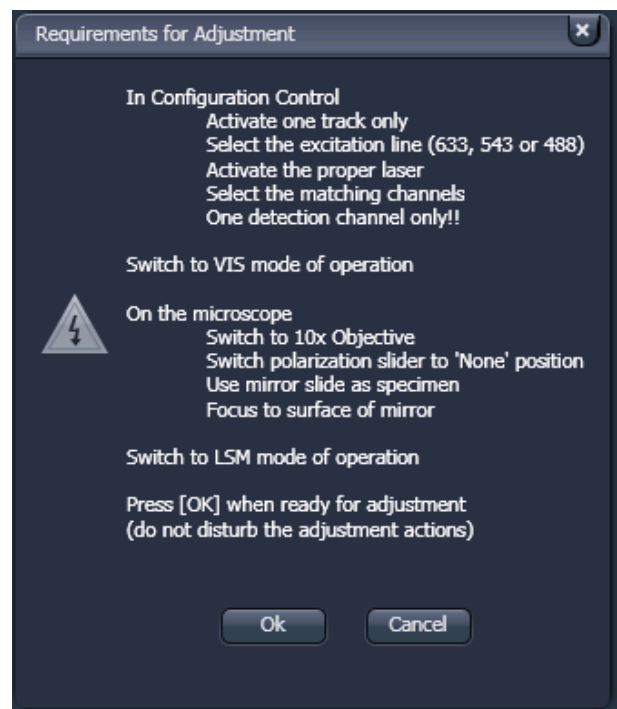


Fig. 158 Requirements for Adjustment window

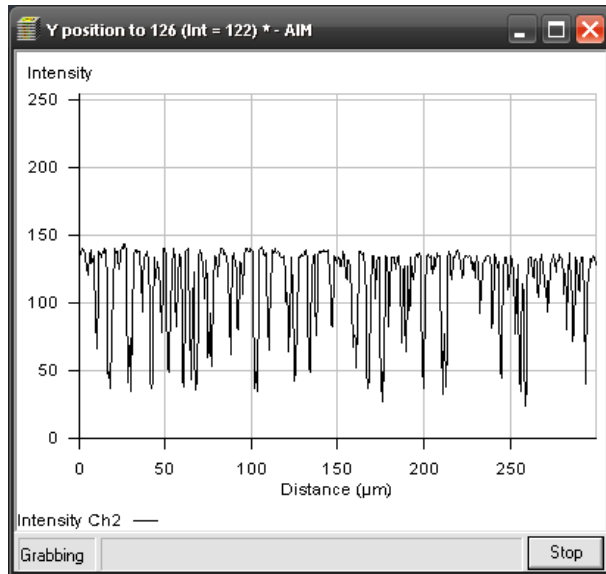


Fig. 159 Pinhole adjustment scan window



A change of the pinhole diameter made manually in the **Pinholes section** panel will update the pinhole diameter in the **Channels** tool and vice versa.



Pinhole adjustment should be done on a regular basis (monthly, depending on system usage).

5.4.2 Objectives

This function permits changed objectives to be activated and the parfocality to be set without having to exit the software. The function can be called up in the **Maintain** panel in the **Objectives** tool of the **Maintain** tool group (see Fig. 160).

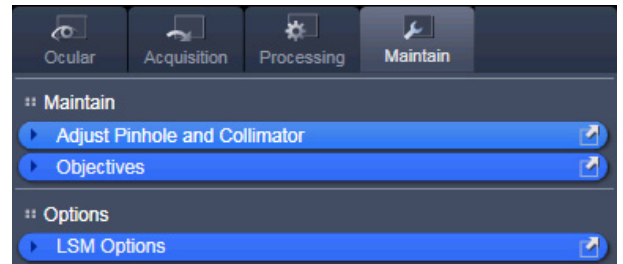


Fig. 160 Maintain and Options tool groups

5.4.2.1 Change Objective

- Change the required objective in the nosepiece.
- Click on the **Objectives** tool in the **Maintain** tool group of the **Maintain** panel.
 - A list of available objectives is displayed with position and name (Fig. 161).
- Click on the graphical button of the relevant nosepiece mount (**Position**).
 - An expansion (**Change Objective**) window appears. All available objectives are listed in the **Potential Objectives**, **User defined Objectives** or **Favorite Objectives** directories of the expanded window (see Fig. 162).
- Select the new objective by highlighting it from the appropriate **Objectives** directory. Press the **Set As New Objective** button to assign the objective to the selected **Position**.
- Click anywhere outside the expansion window to close it.

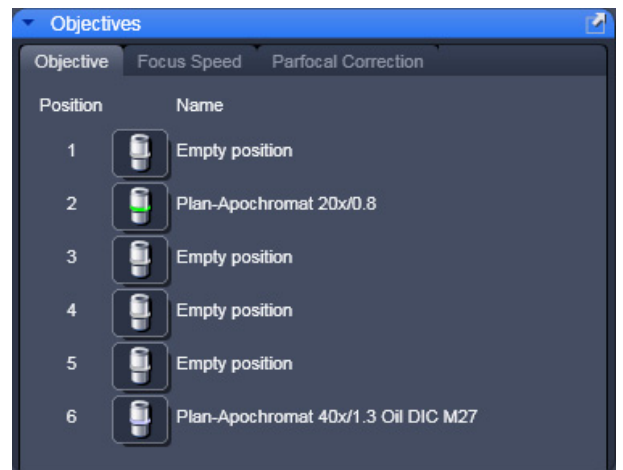


Fig. 161 Objectives tool

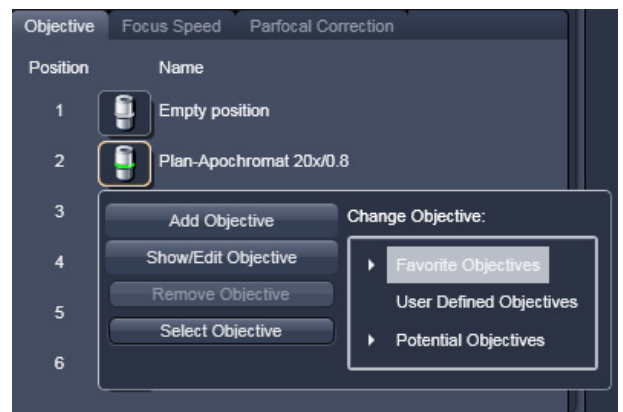


Fig. 162 Change objective window

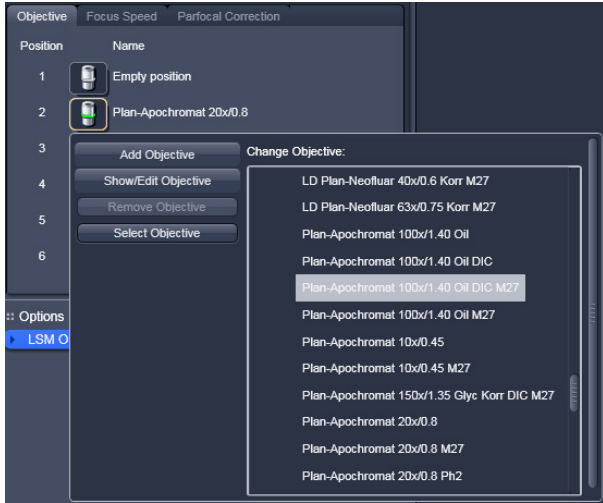


Fig. 163 Add Objective window – Potential Objectives

5.4.2.2 Add Objective

This function permits new objectives to be added to the database.

For this, proceed as follows:

- Click on the **Add Objective** button on the **Change Objective** window (Fig. 163).
 - An expansion (**Create new Objective**) window is opened (Fig. 164).
- Enter the data of the new objective in the appropriate display boxes of the expansion window, and then click on the **Apply Add** button.

The new objective is stored in the database in the objective directory under **User defined Objective**.

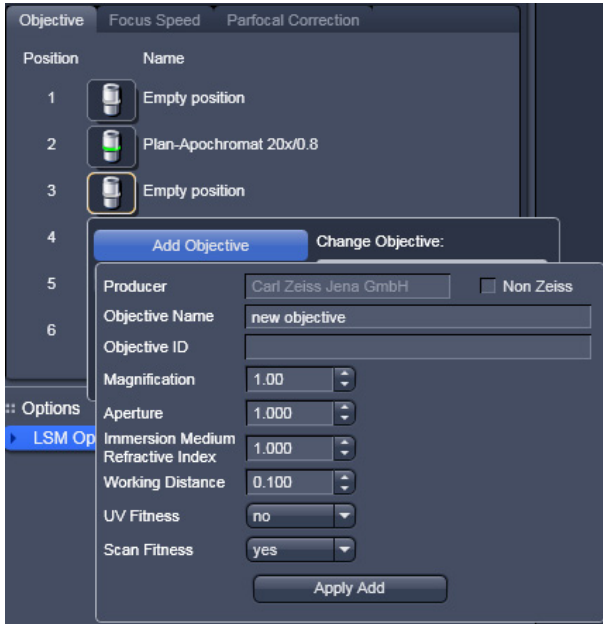


Fig. 164 Editing a new objective



If you have activated the **Non Zeiss** check box, objectives from other manufacturers can also be included in the database.

5.4.2.3 Remove Objective

You can remove user-defined objectives. Hence, all objectives in the **User Defined Objectives** directory can be deleted (see Fig. 165).

- To remove an objective from the database, select it with a click of the mouse in the expansion (**Change Objective**) panel and then click **Remove Objective**.

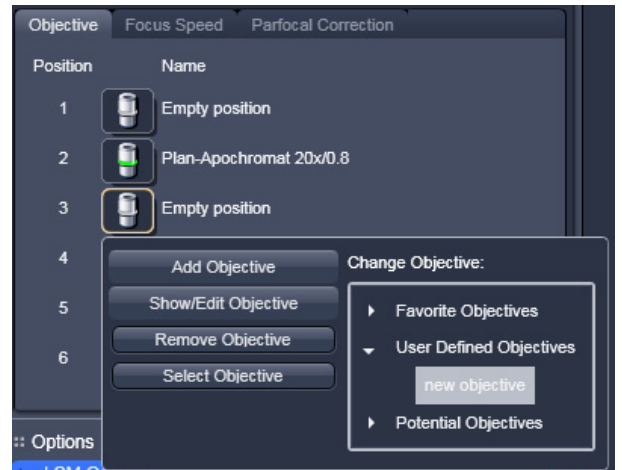


Fig. 165 Remove an objective

5.4.2.4 Edit Objective

You can edit user-defined objectives. Hence all objectives in the **User Defined Objectives** directory can be edited.

- To edit an objective from the database, select it with a click of the mouse in the expansion (**Change Objective**) panel and then click on **Edit Objective**. An expansion (**Edit user Defined Objective**) panel will open and the parameters of the Objective can be edited. Only those parameters are accessible that are allowed to be changed. Other parameters are grayed.
- Press the **Apply Edit** button to store the new annotation.

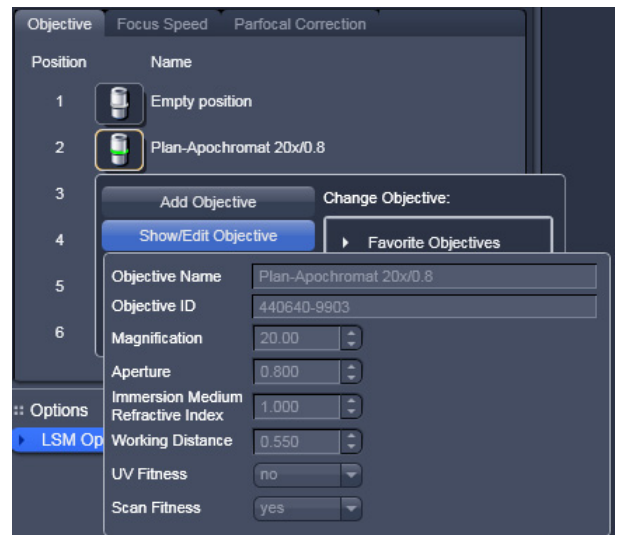


Fig. 166 Edit an objective

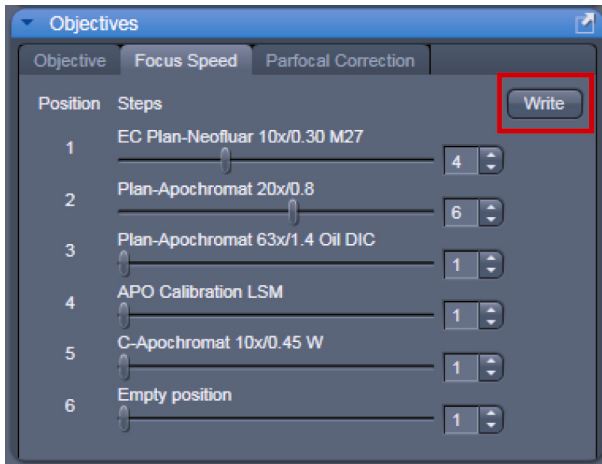


Fig. 167 Focus speed setting

5.4.2.5 Focus Speed

The focus Speed can be changed for every objective present in the nosepiece via the **Focus Speed** tab in the **Objectives Tool**. Use the speed sliders to set the speed and the **Write** button in order to take over the changes also for manual Z-control on the microscope.

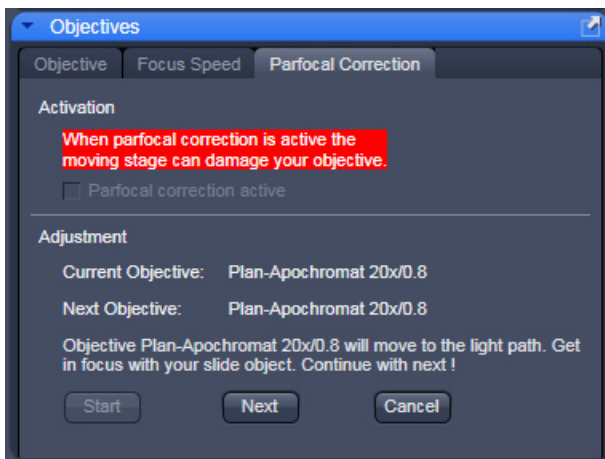


Fig. 168 Parfocal correction

5.4.2.6 Parfocal Correction

Parfocal Correction for different Objectives can also be done within the **Objectives Tool**.

To activate the parfocal correction, tick the tick box **Parfocal correction active** Parfocal correction active.

For adjusting the individual objectives press the **Start** button. The first Objective will be used. Focus on a thin sample (Cells or grid) and press **Next**. The next Objective will be used. Continue this procedure for all objectives present on your system.



CAUTION

If Parfocal Correction is in use, a motorized stage can damage your objective!

5.4.3 LSM Options

In the **LSM Options** tool the following user-accessible program **Settings** of the ZEN software are available (see Fig. 169):

- **Load configuration**
- **Re-use**
- **Hardware**
- **Image display**

- Click on the respective register to display the panel.

(1) Load configuration

Load configuration (see Fig. 169) lists parameters to be taken into consideration (if checked active) for loading an imaging configuration.

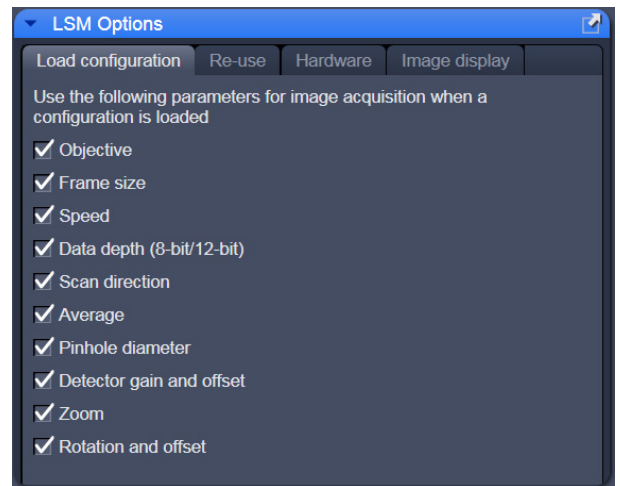


Fig. 169 Options tool with load configurations panel opened

(2) Re-use

Within the **Re-Use** panel (see Fig. 170) you can determine whether the objective setting and/or the collimator setting stored with the image should be taken over when the **Reuse** function is used.

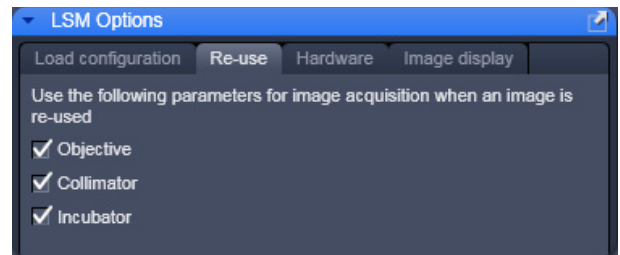


Fig. 170 Options tool with re-use panel opened

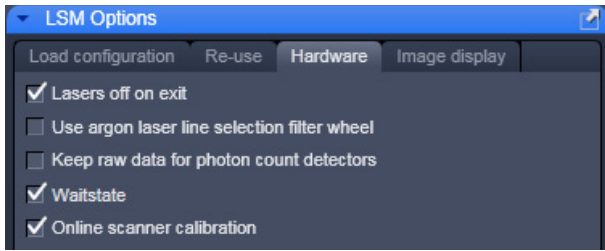


Fig. 171 Options tool with hardware panel opened

(3) Hardware

Press the **Load configuration** register to open the panel.

The **Hardware** tab (see Fig. 171) allows you to set several hardware defaults.

By activation of the **Lasers off on Exit** check box the lasers are automatically switched off when the ZEN software is closed. The lasers are allowed to cool for five minutes before they are switched off.

The Z-Stack **Waitstate** function is recommended for acquisition with scanning stages, high power objectives and short acquisition times on Axio Imager stands. **Waitstate** is on as default setting. This function delays the image acquisition during time series or Z-Stacks in case vibrations of the stage occur and are registered at the beginning of individual images. The delay is set to 350 ms. This can occur for specific image acquisition settings and is dependent on the speed, the stage and the objective in use.

Online scanner calibration (OSC) is on as default setting. This function assures the calibration of the scanners for bidirectional scanning. If that function is not checked it might be required to calibrate the scanners in x and y manually when bidirectional scanning is used for image acquisition. Nonlinear bidirectional distortions especially at high acquisition speeds (10-15) can only be removed by OSC.

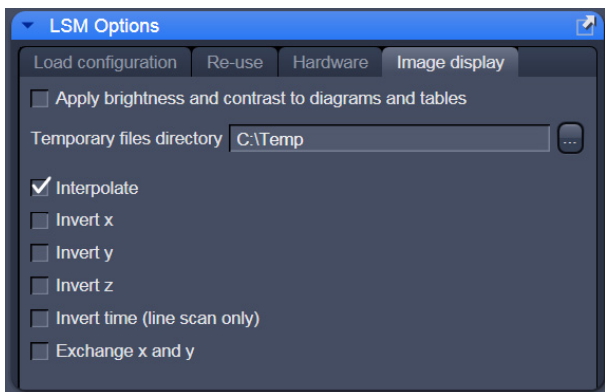


Fig. 172 Options tool with image display panel opened

(4) Image display

Any changes in the **Image Display** will per default not affect the original image data. When the check box **Apply brightness and contrast to diagrams and tables** (see Fig. 172) is marked, any changes in brightness and contrast of the image will also affect the image data shown in diagrams or tables.

The **Temporary Files Directory** can be set manually. For large datasets it is advisable to use a drive **other** than the C-Drive of your computer.

Interpolate: Interpolates the signal between pixels and thus smoothens the image. This interpolation is not saved with the original image data and can be active also during acquisition.

For the options **Invert x**, **Invert y**, **Invert z**, **Invert time** and **Exchange x and y** the original data are also not changed when those options are applied.

6 Center Screen Area / Image Containers - Display and Image Analysis

6.1 Structure and Functional Concept of the Center Screen Area and the Image Display Container

6.1.1 General Structure

In this section, the Center Screen Area of the **ZEN Main Application** window is described. The **Center Screen** area can be set up to hold 1, 2 or 3 **Image Containers**. Fig. 173 shows the layout with one or two Image Containers.

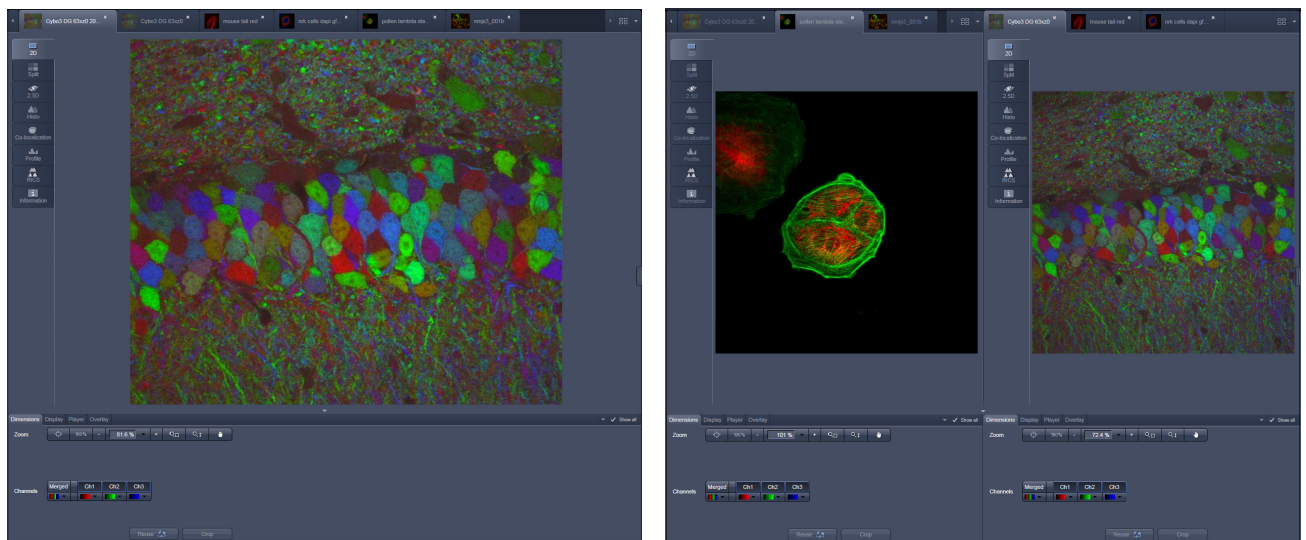


Fig. 173 The Center Screen Area of the ZEN Main Application window – Left: 1 Image Container, Right: 2 Image Containers

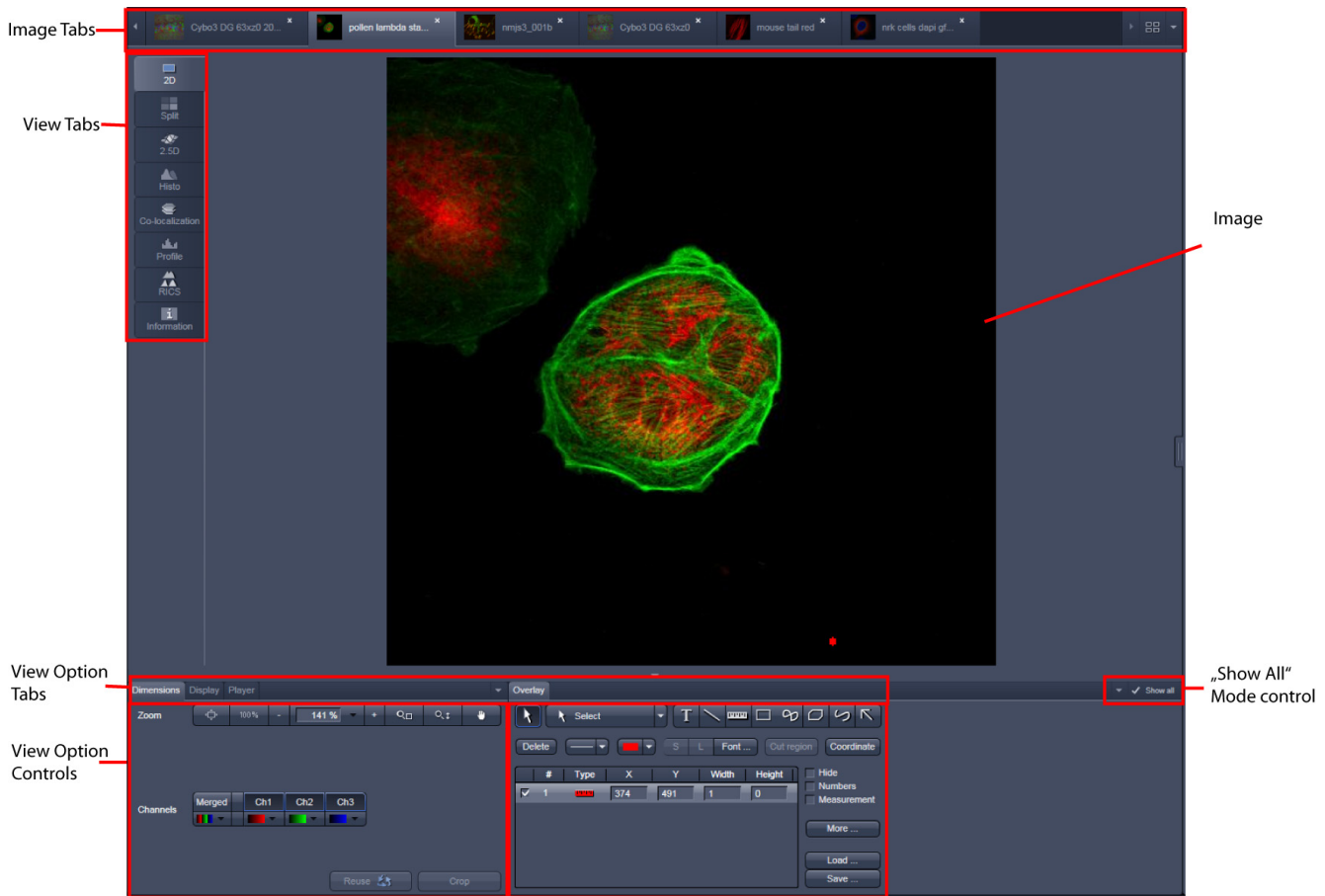


Fig. 174 Image Display window; Select - Overlay

View tabs:

The View tabs make all viewing options and image analysis functions directly available from the main view. Switching from one View tab to another, changes the view type for the currently active image, keeping the image in the foreground. This avoids several display windows for different analysis tools and keeps all information always right at hand.

☞ After switching between several open images, upon returning to a previously activated Image tab, the image document "remembers" which view type was activated before and displays the same parameters upon return to this image.

Image tabs:

The Image tabs show every opened window so they are easy to find and access even when the **Open Images** panel in the **Right Tool Area** is hidden/minimized. This way of organizing open images avoids the problem of many opened image display windows lying on top of each other. The **Image Container** concept allows large numbers of images open at the same time and having them all easily accessible while keeping the workspace organized and tidy. **Image** tabs can show the image file name only (Fig. 175/a), the name and a small image thumbnail (Fig. 175/b) or the file name and a larger image thumbnail (Fig. 175/c). This can be configured in the Container Context menu (see Fig. 177).

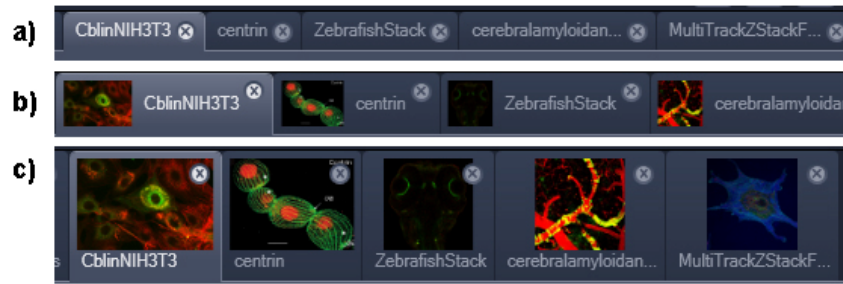


Fig. 175 Image Display window; Select - Overlay

View Option control tabs:

These tabs allow individual activation / deactivation of the available **View Option** control blocks by clicking on the tabs. Available but hidden View Option Control tabs are grey. Active tabs are displayed in front of the others.:



The **View Option** control tabs:

The **View Option** control tabs are placed in the area under the image display. Each block hosts functionally related tools for image analysis, display modification and data manipulation. There are two groups of **View Option** control tabs: A general one which contains the blocks **Dimensions**, **Display**, **Player** and **Overlay**. The second group consists of **View** tab-specific tool tabs hosting tools that are functionally linked to only one view type. The View tab Specific control tabs are marked with a blue triangle on their upper right corner. **Histogram** The control tabs of the general group and their respective tools are described in the section for **2D View** (the first and default **View** tab).

Tab mechanics:

All tabs of the two groups can be dragged out of their groups and placed freely in the **View Options Area**. Where ever it is possible to drop a grabbed tab – the underlying area is displayed in blue:

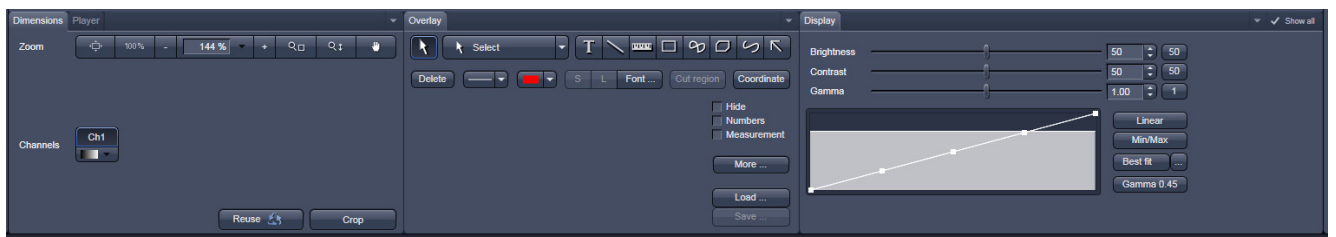
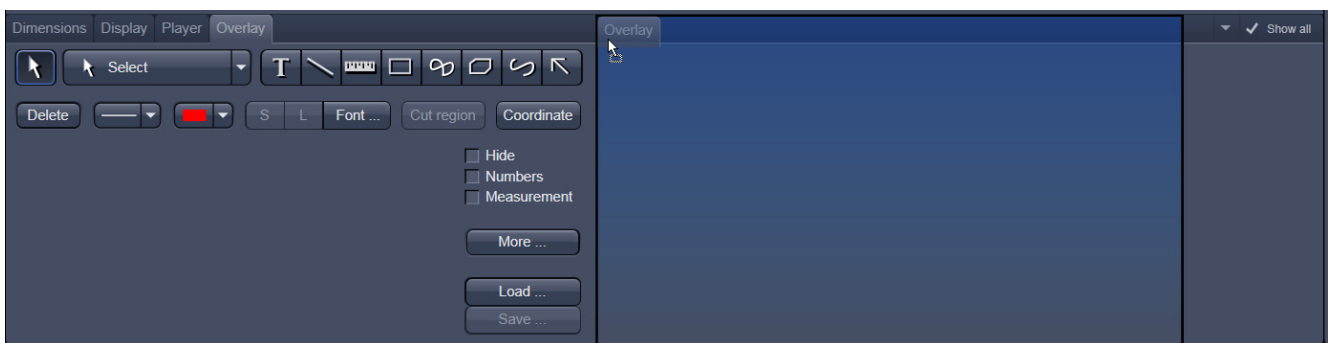
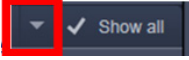


Fig. 176 General View Options control blocks

In order to reset the tab layout – use the entry **Reset Tab Layout** in the context menu or click on the



triangle  to access the View Options Area menu.

Show all mode of the View Options Area:

Activating the **Show all** mode  of the View Options Area has two effects:

- a) In every view options control tab all the available tools are shown; de-activating the **Show all** mode hides less often used tools.
- b) All available view options control tabs are shown; de-activating the **Show all** mode hide less often used tabs.

Any changes done with these tools have immediate effect on the image display but not on the saved data. To permanently store your results you have to save the data as described in section **Subset** and/or **LSM Options**.

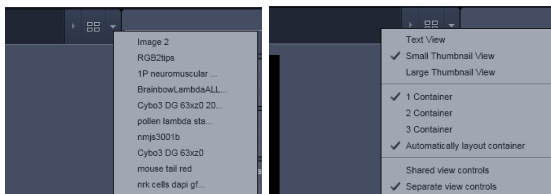


Fig. 177 Open Image pull down and context menu of the Center Screen Area


Image Handling and Container Layout Configuration:

This little control area (Fig. 177) on the top right corner of the Image Display is for scrolling and listing the Image tabs which can not be displayed if too many images are opened. This is just an alternative way of handling the open images. The main tool for this purpose is the **Open Images** panel (see section **Right Tool Area, Data Management and Storage**). A right click opens the context menu for the layout of the Center Screen Area.

The Image Display:

The Image Display contains and displays the image data or –depending on the active view type – a combination of image data, overlays, graphs and tables. The content is automatically maximized to the available image or display size.

Expose Mode:

Clicking the **Expose Mode** button  in the top right corner of the Image Display opens a field of thumbnails in the image display with one large thumbnail for each open image. Whenever you lost track of your open images, open the Expose Mode and click once in the image you are looking for and it will be immediately brought to the foreground of the Image Display (Fig. 178).

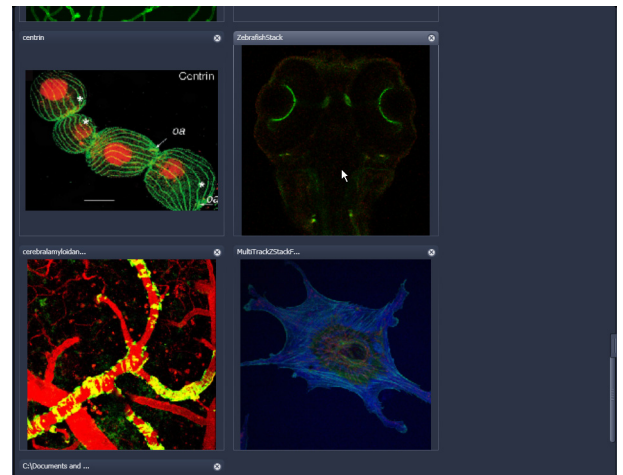


Fig. 178 Expose Mode Display

6.1.2 Container Configuration with the Container Context Menu

Clicking on the container background with the right-mouse button opens a context menu for:

- setting the view for the Image tabs (see above),
- choosing to split the Center Screen Area in 1, 2 or 3 containers and setting the automatic container layout
- choosing between separate or shared view controls between the containers.

The same menu is available in the menu bar in the **View** part of the menu.

Splitting the Center Screen Area in several containers has the advantage that side-by-side comparison of image data becomes very easy.

The disadvantage is that the individual container necessarily becomes smaller. Up to 3 containers can be chosen. The "Automatically layout container" option is switched on by default and fixes the container width in layouts with multiple containers. In two-monitor setups it also fixes the right edge of the first container to the monitor edge.

If **Separate view Controls** are chosen, each container has its own set of View Options control blocks. If a **Shared view Controls** is chosen, the set of View Options control tabs spans the whole area under the containers. The tools and functions always apply to the currently active container / image.

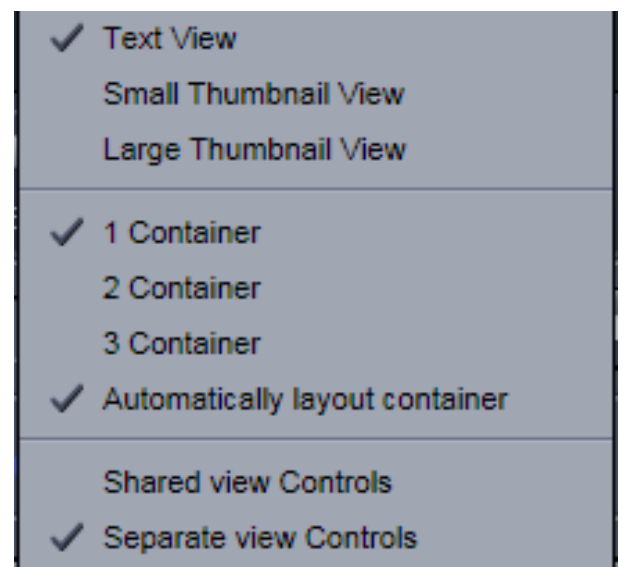


Fig. 179 Container Context menu

6.2 2D View

This function allows to

- display a single image in frame mode,
- display multiple channel images in superimposed mode.

The following **View Option** control blocks apply to this View Type:

Dimensions, Display, Player and Overlay.

In the 2D view, only the general **View Option** control block is displayed. These view option blocks are also available in those other view options in which the functions are applicable.

The general view option control blocks are only described in this section.

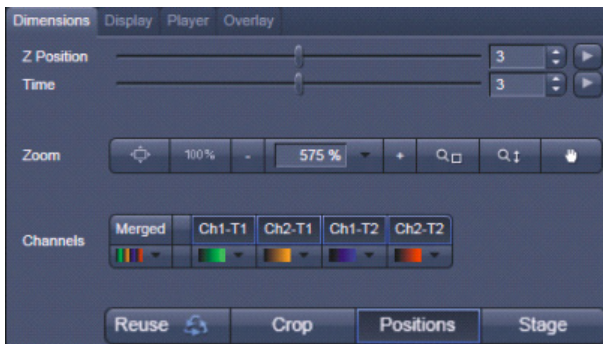



Fig. 180 View Options control block - Dimensions

6.2.1 Dimensions

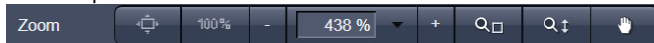
The **Dimensions View Options** control block holds the tools to modify the image display with respect to the (multiple) dimensions of the image data set.

The sections (slices) in the dimensions can be scrolled with sliders (z-position and Time in Fig. 180 and also directly addressed with setting numbers in the spin-boxes next to the sliders.

The small  button on the right hand side of the spin-boxes starts and stops an animation in the respective dimension. This basic animation can not be customized. For all other player-functionality refer to the **Player View Block**.

(1) Zoom

In the Dimensions View Options control block there are 8 buttons related to changing the zoom factor of a displayed image:



Any changes on these buttons affect the displayed image immediately. The zoom function can be performed online.

The functions of the individual buttons are:



Zoom Normal: The image is fitted automatically to size of the **Image Display** window which is always the originally displayed size.



Zoom + enlarges the image.



Zoom - reduces the image.



Zoom 100 % displays one pixel of the image also as one pixel on the screen.



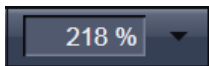
Zoom-Mouse allows you to enlarge / reduce the zoom factor of an image using the left / right mouse button, provided that the cursor is inside the image.



All (only in **Gallery** or **Split** view) When active it allows you to zoom all images of a gallery to the same extent without changing the display image format.



Zoom selection via mouse: draw the area to zoom in directly on the image.

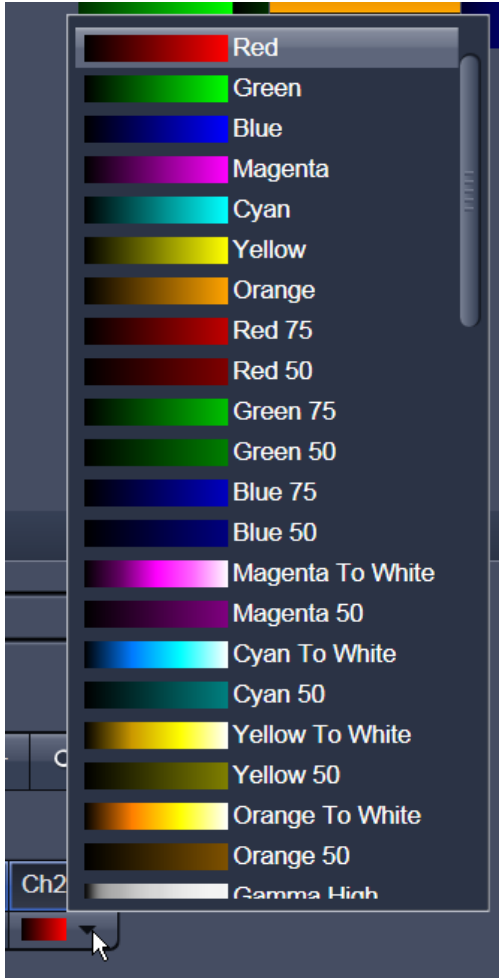


Display box: type in your magnification value in percent directly.

Slider



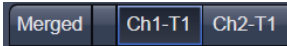
The zoom factor can be set by moving the slider. The display box displays the current zoom factor in %. 100% corresponds to the original size.



(2) Dimensions – Channels

The **Channel(s)** buttons are designed to switch on/off channels or the display of the merged image as well as to assign color look-up tables (LUTs) to the individual channels:



Clicking on the  buttons switches the respective channels on/off in the display.



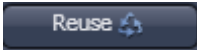
Clicking on the  buttons switches forth and back between the assigned LUT and the **Range Indicator**. Clicking on the little black arrow on the  buttons opens a selection of color look-up tables to assign a color or LUT to the respective channel (see Fig. 181). Any changes on these buttons affect the displayed image immediately.

Fig. 181 Image Display - Dimensions - Channels

(3) Reuse

Clicking the  button transfers **ALL** acquisition parameters (exception: objective and collimator, see below) from the stored image data to the **Microscope Hardware Settings / Control tools** and applies those parameters directly to the system.



The acquisition parameters of an image are displayed in the Information View (section **Information View**).

In the **Maintain** tab (section **LSM Options**) (**LSM Options - Reuse** tab), it can be set whether the objective and the collimator settings are also "re-used" and applied to the system. **Reuse** of the microscope objective only works in microscopes with motorized objective revolvers.

(4) Dimensions – Crop

This function allows to interactively define the size and orientation of a rectangular scan area on the image displayed in the **Image Display** window.

The defined area is synchronized with the **Zoom, Offset and Rotation** parameters in the Scan Area panel (partially **Show all** mode) in the **Acquisition Mode** tool (section **Tool Group Online Acquisition: Acquisition Mode Tool**).

Click on  will display the **Crop Rectangle** in the **Image Display** (Fig. 182). Any changes done with the **Crop Rectangle** are setting the scan parameters immediately. On the next execution of a scan (**Auto Exposure, Live, Continuous, Snap**) these new scan parameters will be applied. To reset the crop function and use default values set **Zoom=1, Offset=0** and **Rotation=0** in the **Scan Control** window in the Scan Area panel in the **Acquisition Mode** tool (or click "reset all" in the same panel). When the  button is de-selected, the scan parameters are reset as well.

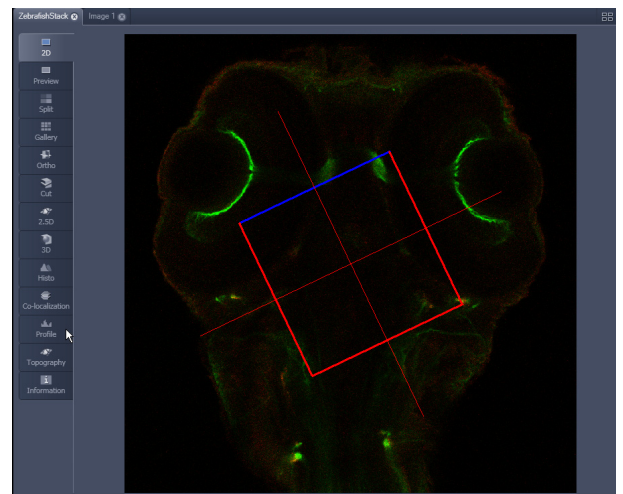






Fig. 182 Image Display - Dimensions - Crop

The **Crop Rectangle** is controlled via the following functional elements:

- Offset**  Click into the crop rectangle, keep the left mouse button pressed and drag the crop rectangle to the required position. Release the mouse button.
- Zoom**  Click on a corner of the crop rectangle, keep the left mouse button pressed and set the required size. Release the mouse button.
- Rotation**  Click on one end of the crosslines, keep the left mouse button pressed and set the required rotation angle. Release the mouse button. The first line scanned is highlighted in blue.
- Side ratio**  Click on any of the intersection points between crossline and crop rectangle, keep the left mouse button pressed and change the side ratio as required. Release the mouse button.

(5) Dimensions – Positions

When clicking Positions a crosshair will be displayed at the cursor position in the image. With a mouse click the position of the crosshair in the image will be added to the Positions list in the Stage tool and the Positions tool.

(6) Dimensions – Stage

Stage will show the cursor as a rectangle with a crosshair in the centre. With a mouse click the stage (and therefore the sample itself) will be repositioned. The image position with the cross hair will become the centre position of the stage and therefore the centre position of a next image

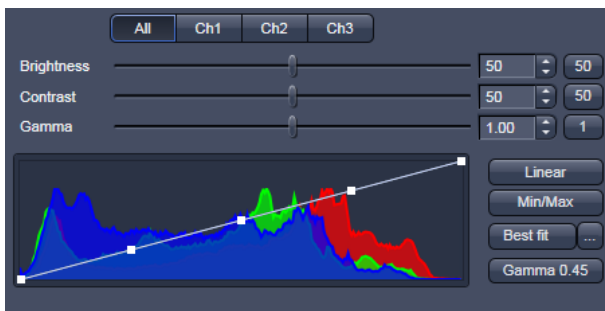



Fig. 183 View Options control block - Display

6.2.2 Display

In the **Display** View Option control block, **Brightness**, **Contrast** and **Gamma** of the displayed image can be adjusted (Fig. 183). With the **All**, **Ch1**, **Ch2**, **Ch3** buttons, the effect of the slider settings can be restricted to an individual channel. By default, the settings apply to all channels simultaneously. The parameters can be changed with sliders or spin-boxes – or directly by typing in numbers in the number-field. With the **50** - **50** - **1** buttons, the original settings are easily re-set.

 The settings in this View control block apply only to the Image Display and are NOT changed in the original data set. To write the changed settings to the image data set, use the **Burn in Brightness and Contrast** function in the **Processing** tab (section **Processing Tab**).

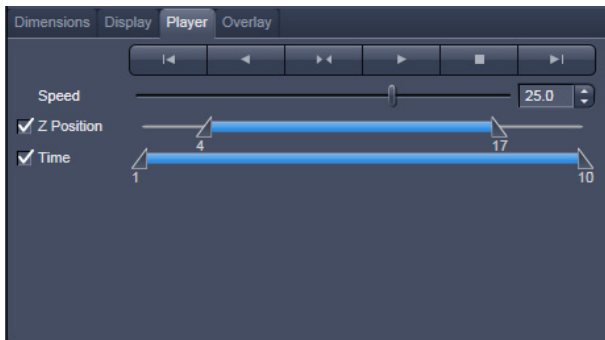


Fig. 184 View Options control block - Player

6.2.3 Player

This function allows to

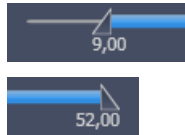
- animate frames of a Z-Stack or a time series
- specify animation parameters such as range and animation speed

When the image displayed in the **Image Display** window is neither a Z-Stack nor a time series this View Option control block is empty.

The **Player View Option** control block is controlled by the following elements:

Z Position

The **current position** slider is displayed in the View Option control block **Dimensions** and can also be moved manually or by entering the slice number in the input box. The slider can be accessed only, when the player animation is off.



Start and **End** slider: The setting of the **Start** sliders limits the number of slices to be used for the animation. Slices before **Start** and after **End** are not taken into animated. These sliders can be changed during automatic animation.



Starts the forward motion of the automatic animation. After the last slice has been passed, restart is made at the first slice.



Starts backward motion of the automatic animation. After the first slice has been passed, restart is made at the last slice.



Starts the combined forward / backward motion of the automatic animation, i.e. when the last slice has been reached, the backward motion is activated, and the forward motion is activated again on reaching the first slice.



Stops the automatic animation.



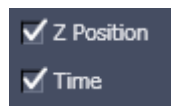
Move to the first slice.



Move to the last slice.

Speed

Speed can be set through a slider or spin-box (selection box).



Multidimensional animations can be selected by including individual dimensions by checking tick boxes.

6.2.4 Overlay

This function allows to

- select from a set of drawing functions such as rectangles and arrows,
- add a scale bar to the image, as well as text annotations,
- use a set of interactive measurement functions for length, angle, area and size,
- add a text box that displays the coordinate of a hidden dimension (e.g., the z-position in a Z-Stack or the timestamp in a time series).

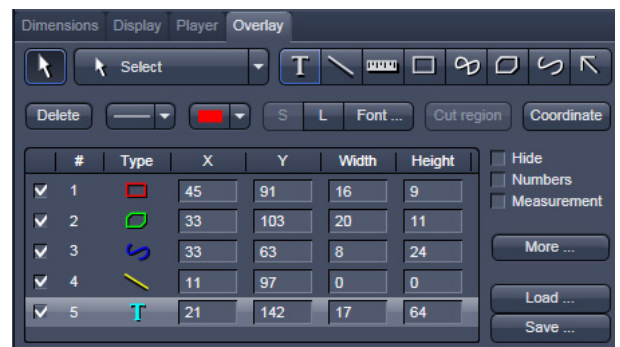


Fig. 185 View Options control block - Overlay

Functional Description

The overlay function uses a plane separate from the image plane (the graphics plane) and therefore does not change the content of the image(s).

The overlay view option control block is available in all View Types except **2.5D**, **Lambda Coded** and **Preview**.


Any changes done with this function are effective immediately.


The overlay graphics can be stored in the images or separately in a file from where they can be re-loaded.


Available functions in the Overlay View Control Block




Fig. 186 Overlay view control block

The following list describes the most common functions in the **Overlay** view control block. More can be found in the  pull down menu.

- 

Select tool: Activation of the mouse cursor for selection, resizing or movement of an overlay element in the Image Display.
Resizing: Click on the handle and hold down the mouse button, drag the handle, release the mouse button.
Movement: Click on the line and hold down the mouse button, move the entire element, release the mouse button.
- 

Line tool: Creation of a straight line in the Image Display.
Click and hold down the mouse button, draw a line in any required direction, release the mouse button to end the procedure.
- 

Rectangle tool: Creation of a rectangle in the Image Display.
Click and hold down the mouse button, draw a rectangle in any required direction, release the mouse button to end the procedure.



Closed polyline tool: Creation of a closed polyline figure in the Image Display. The first click sets the starting point, each additional click adds a further line, a click with the right mouse button closes the figure and ends the procedure.



Open Bezier tool: Creation of an open bezier figure in the Image Display. The first click sets the starting point, each additional click adds a further line, a click with the right mouse button ends the procedure.



Ellipse tool: Creation of an ellipse in the Image Display. This tool is available through the pull down menu. The first click sets the center point, the displayed line permits the determination of the first dimension, the second click sets the first dimension, the second dimension and rotation direction can then be determined, the third click sets the second dimension and direction and ends the procedure.



Line with arrow button: Creation of a line with arrow in the Image Display window. Click and hold down the mouse button, drag the line in any required direction, release the mouse button to end the procedure.



Scale bar: Creation of a horizontal or vertical scale bar with default increments in the Image Display. Click and hold the mouse button for the starting point, drag horizontal or vertical scale, release the mouse button to end the procedure.



Gray tones / color shades button: Generates a rectangle with a display of gray tones or color shades in the image.



Text (Annotation) tool: Creation of a text box in the Image Display. After clicking on T, the Text window will be displayed, and text can be entered via the keyboard. The Font ... button enables you to select the font style and size in the Font window. The entered text will be displayed in the left upper corner of the Image Display window after clicking on OK and can be moved to the required position using the mouse. The Text window can also be activated with a double-click on a created text box, and the entered text can be edited subsequently. Insert opens up a further window which allows you to annotate coordinates, time and Z-position with either automatic or user definable units and precision. This annotation is updated during image acquisition and can be exported with the image. The annotation can be stamped into already existing images.



Delete button: All the overlay elements and dimensions in image are deleted. If one overlay element was marked before, only this element will be deleted from the image.



Measurement of the overlay element in the Image Display window. On activation of the Measure button, the selected overlay element and all the elements created afterwards are measured and assigned with a measuring value. The measuring value can be shifted without regard to the overlay element. If of importance, the length and perimeter of a line figure, the area of a closed figure and the inclination angle of a single line will be displayed. On deactivation of the Measure button, the measuring value of the selected element is no longer displayed, and all the elements created afterwards will not be assigned with a measuring value.



Line thickness pull down: sets the line thickness of the selected element.

Cut region

Cut Region tool: The region of a Z-Stack or 4D-image surrounded by an Overlay element is extracted and displayed separately in a new Image Display. This function is only active if the active Overlay element defines a closed contour or volume.



Color selection pull down: In this pull down, different colors can be assigned to the overlay elements with a click of the mouse. A selected color is automatically assigned to the currently selected overlay element and to all elements created afterwards.

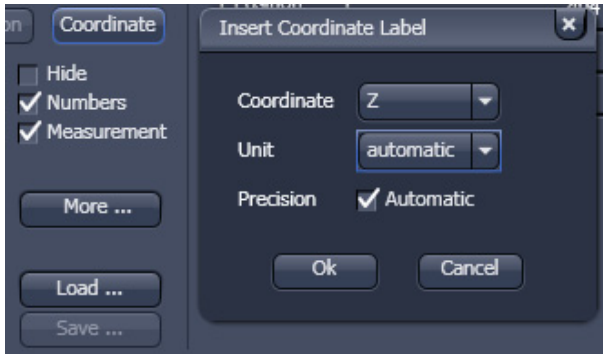
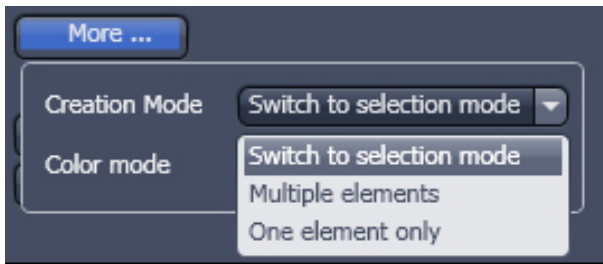


Fig. 187 View Options Overlay - Coordinate

To insert a **Coordinate Label** in the image display, click the **Coordinate** button. The coordinate settings dialog (Fig. 187) offers the available settings and upon clicking **OK**, the selected coordinate is displayed as a text field in the image display. This text field is always immediately updated when the slice/section/time point is changed in the display by changing settings in the **Display View Option** control block or, for example, starting the **Player** animation. This feature is particularly useful to display time or z-position in an exported animation movie for presentations (see Fig. 186).



More ...: The **More** options (Fig. 188) allow toggling the:

Creation of Overlay Mode between

- **Switch to selection mode:** default setting, always switches back to the **Select** tool after creation of an overlay element.
- **Multiple Elements:** allows to create one overly element after the other with the selected overlay element type, without need to re-select the respective tool.
- **One element only:** In this mode, only one element in the overlay plane is allowed. Creating a new one deletes the previous one.

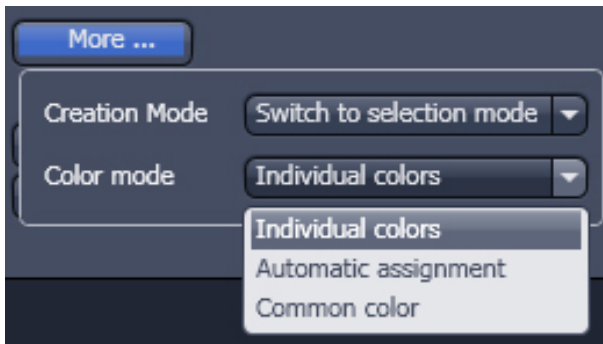


Fig. 188 View Options Overlay - More

Color Mode between

- **Individual colors:** The color of each element can be selected with the color selection pull down.
- **Automatic assignment:** The color of the overlay elements are assigned automatically
- **Common color:** All elements have the same color.

Activation of the tick box **Hide** keeps all overlays of the image document hidden.

Activation of the tick box **Numbers** displays the number of every overlay element in the image display

To load / save overlays from / to a file use the **Load / Save** buttons in this View Options control block. Naming and location in the file system can be set individually.

6.2.5 Preview View

The Preview View Type is an enlarged copy of the thumbnail Previews described in the section **Processing Tab**.

6.3 Split View

This function allows to

- display the individual channels of a multi channel image as well as the superimposed image.

The settings of the **Dimensions**, **Display**, **Player** and **Overlay** view options control blocks apply with the following additional features:

- The **Dimensions** View Options control block shows the **Merged** tick box to activate / deactivate the display of the channel overlay and a **Zoom All** button is added synchronize zooming to the Dimensions view control block.
- Overlay elements are always displayed in all channel displays.

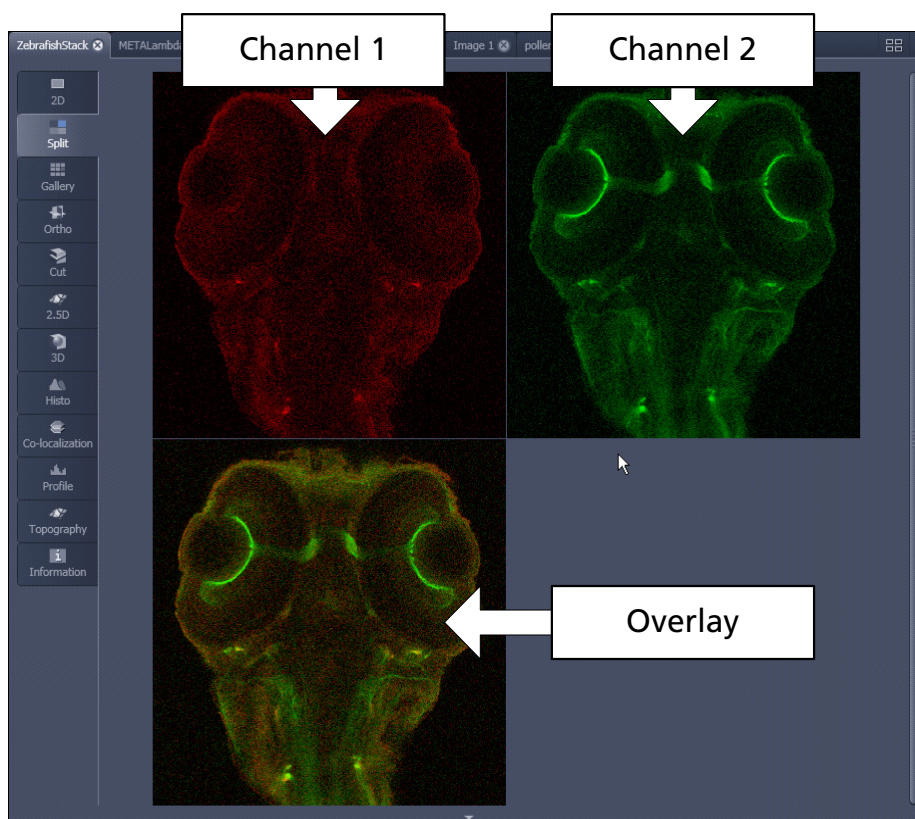


Fig. 189 Image Display, Split view type



This function is useful to optimize the individual channels in a multi channel image acquisition together with the **Range Indicator** palette.

6.4 Gallery View

This function allows to:

- display images (Z-Stack, time series, combination of both) side by side in a tiled fashion,
- add data relevant to the displayed images (Z-Stack slice distance, time of acquisition or wavelength),
- extract a subset of images from the original stack and store the result as a new image (controls for this function are in the **Processing** tab function **Copy** → **Subset** (see section **Subset**).

The settings of the **Dimensions**, **Display**, **Player** and **Overlay** View Options control blocks apply.

The additional view-specific **Gallery** View Option control block includes a tick box to switch on and off the display of the slice coordinates in the Gallery display. If this text is activated, transparent mode and color can be selected in this control block too (see Fig. 190).

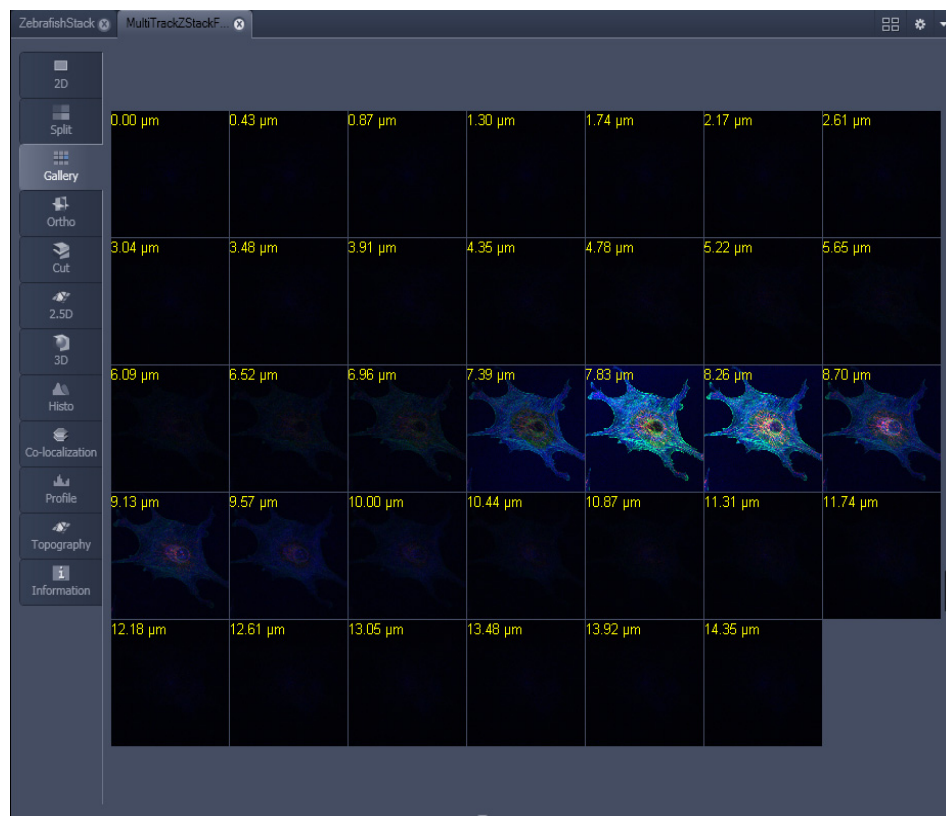


Fig. 190 Image Display window - Gallery display

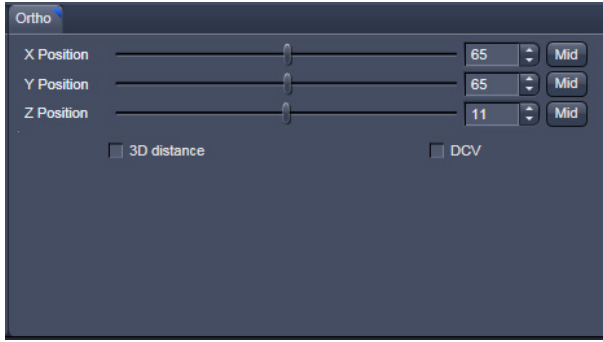


Fig. 191 View Options control block - Ortho

6.5 Ortho View

This function allows to

- display a Z-Stack of images in an orthogonal view
- measure distances in three dimensions

The settings of the **Dimensions**, **Display**, **Player** and **Overlay** view options control blocks apply.

In addition to the 4 general View Option control blocks, the view-specific **Ortho View Option** control block is available (Fig. 191).

In the **Ortho** View, section sliders appear in the **Ortho View Option** control block together with orthogonal projections in the image (Fig. 192).

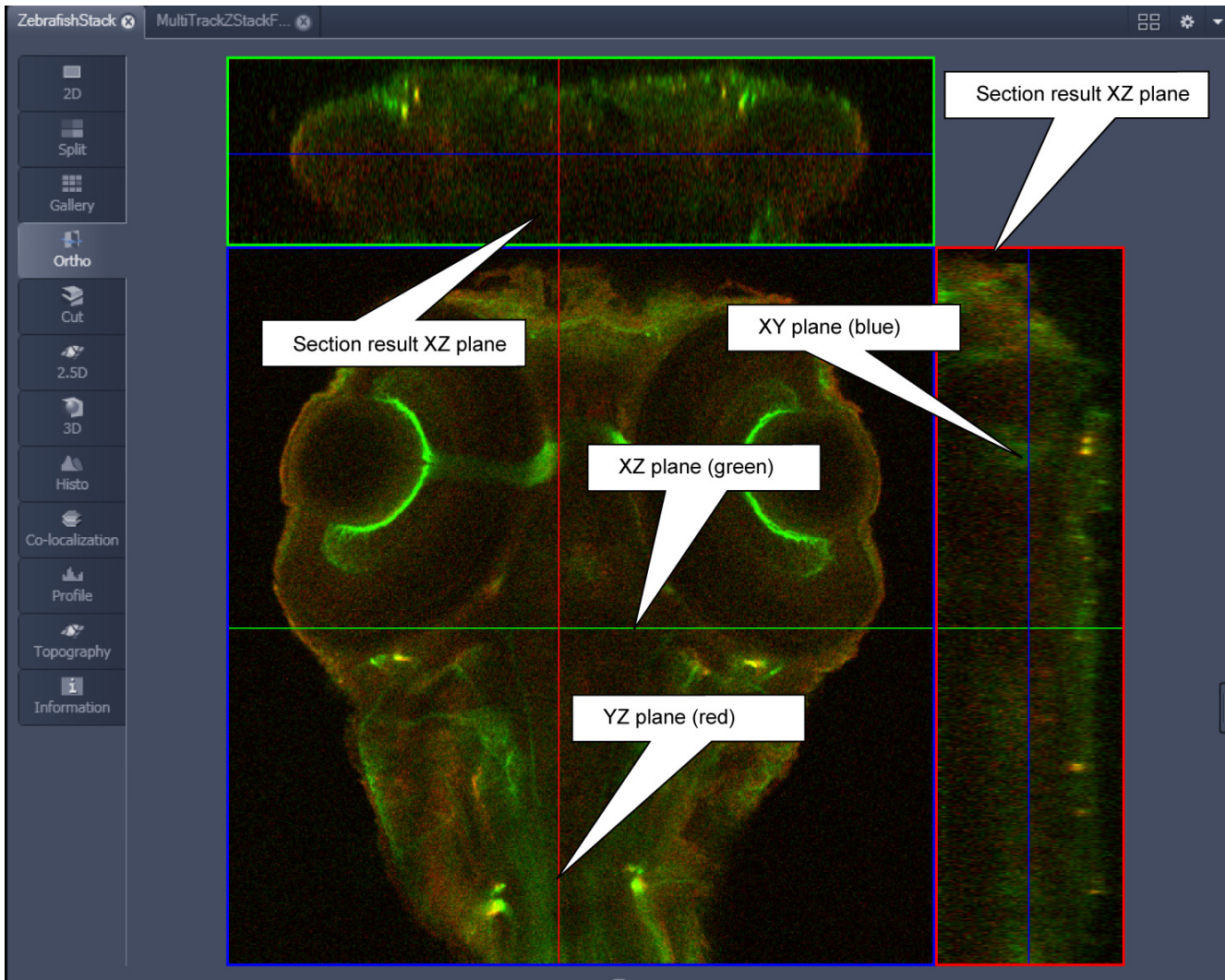


Fig. 192 Image Display - Ortho View

6.5.1 Ortho - Select Function

- By changing the parameters X, Y and Z in the **Ortho** View Option control block, the section plane can be positioned at any XYZ coordinate of the Z-Stack.

The position of section planes can be changed in various ways:

- By moving the sliders on the **Ortho** View Option control block.
 - X and Y settings may range from 1 up to the maximum number of pixels scanned (in the example shown: 512).
 - Z settings may range from 1 to a maximum of n, with n standing for the number of slices produced in the stack.
- By directly entering the relevant number value in the X-, Y- or Z-input box and pressing the **Tabulator** or **Enter** key.
- If you move the cursor into the **Image Display** window, it changes into a crossline symbol \oplus . By positioning this symbol with the mouse you can move the XZ and YZ section planes to any point of intersection with the XY plane. A click with the left mouse button places the intersection to the desired position.
- If you move the crossline symbol \oplus onto the intersection of the red and green section planes, it changes into the: \leftrightarrow symbol. If you now press the left mouse button and keep it pressed you can reposition both section planes **simultaneously**.
- If you move the crossline symbol \oplus onto the green section plane, it changes into the \updownarrow symbol. If you now press the left mouse button and keep it pressed, you can reposition the (green) XZ section plane.
- You can reposition the (red) YZ plane in the same way using the $\leftarrow\rightarrow$ symbol.

The result of an orthogonal section is visible at the image margin.

- Section of the XZ plane (green line) through the stack: above the XY image.
- Section of the YZ plane (red line) through the stack: right of the XY image.
- Section of the XY plane (blue, slice plane of the stack): center image.

6.5.2 Ortho - Distance Function

- Activating the 3D distance tick box permits length measurements in 3D space.
- Click on the **Mark** button to set the first XYZ-point for the measurement of the spatial distance.
- Set the second XYZ-point for measurement by moving the X-, Y-, Z-sliders or by moving the green, red and blue lines in the image.
 - The projections of the spatial distance are shown in the image planes by yellow lines (Fig. 193). The actual spatial distance is calculated and shown in μm next to the **Mark** button.

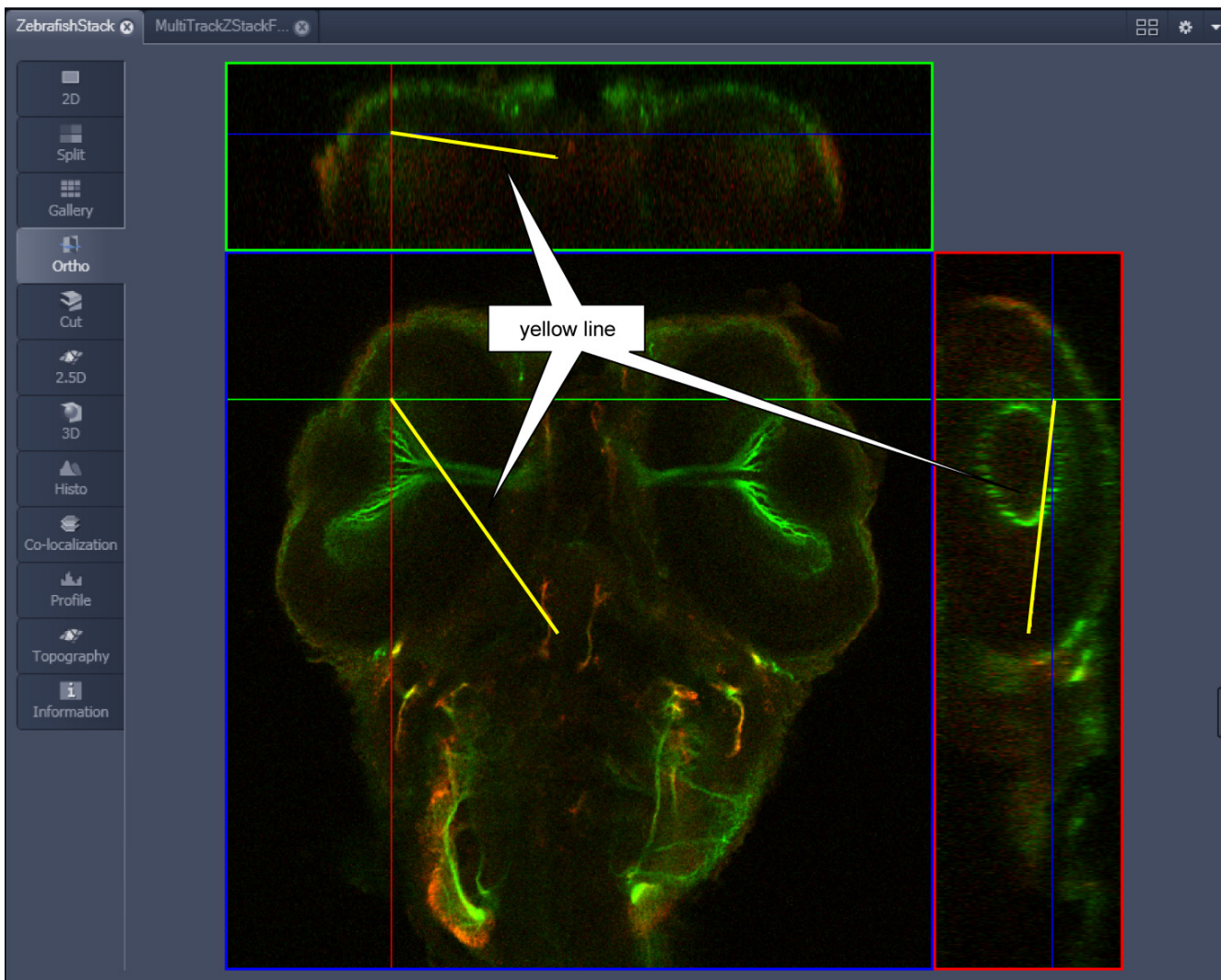


Fig. 193 Image Display – Ortho View - 3D Distance Measurement display

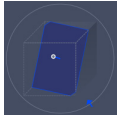
6.6 Cut View

This function allows to display a user defined section plane (= cut plane) of a Z-Stack. It automatically improves the image of the section plane by trilinear interpolation.

The settings of the **Dimensions, Display, Player** and **Overlay** View Options control blocks apply.

Any changes done with this toolbar are effective immediately. The content of the overlay plane is temporarily hidden while the toolbar is displayed.

- By varying the parameters **X, Y, Z, Pitch** and **Yaw**, you can position a section plane of any orientation within the stack volume.
- Clicking the **Mid Mid Mid 0 0** buttons restores the original position.



In order to place the Cut View Plane interactively use the interactive graphic in the cut view control tab.



Fig. 194 Cut View – control block

6.7 2.5 D View

This function allows to

- display the two-dimensional intensity distribution of an image in an pseudo 3D mode,
- show the intensity values in profile, grid or filled mode,
- show separate distribution for each channel in a multi channel image.

 The **2.5 D** button can also be used online during scanning.

The settings of the **Dimensions** View Options control blocks apply. The settings of **Display, Player** and **Overlay** View Options control blocks do not apply.

Any changes done with this toolbar are effective immediately. The content of the overlay plane is temporarily hidden while the toolbar is displayed.

The image display in the **2.5 D View Type** is the same as in the **3D (VisArtplus)** View Type. For a description of the controls in the display window see section **3D Rendering Settings in VisArtplus**.

In brief, the viewing plane of the **Image Display** window can be rotated, tilted either directly with the mouse or by the scroll bars on the right-hand side and the bottom of the **Image Display** window.

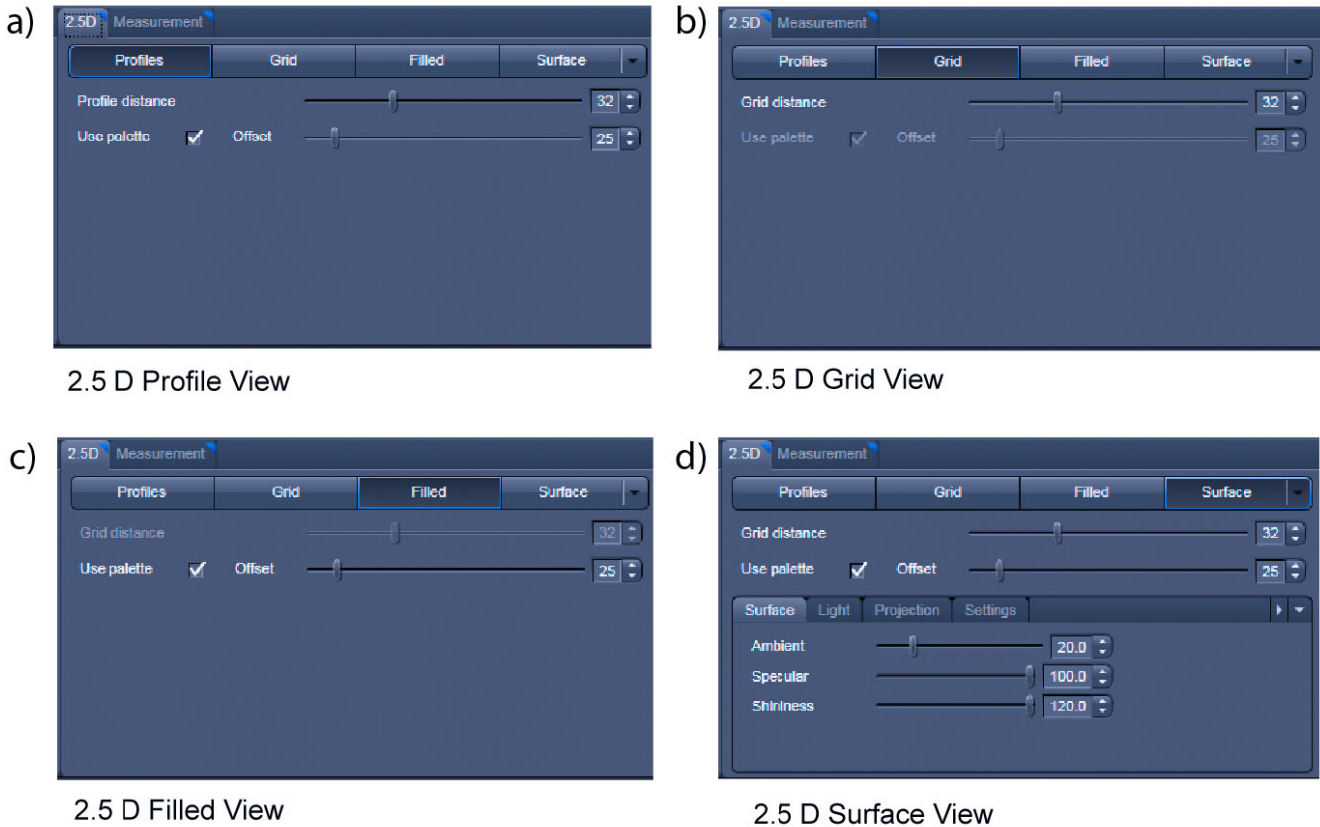


Fig. 195 2.5 D View Option control tabs

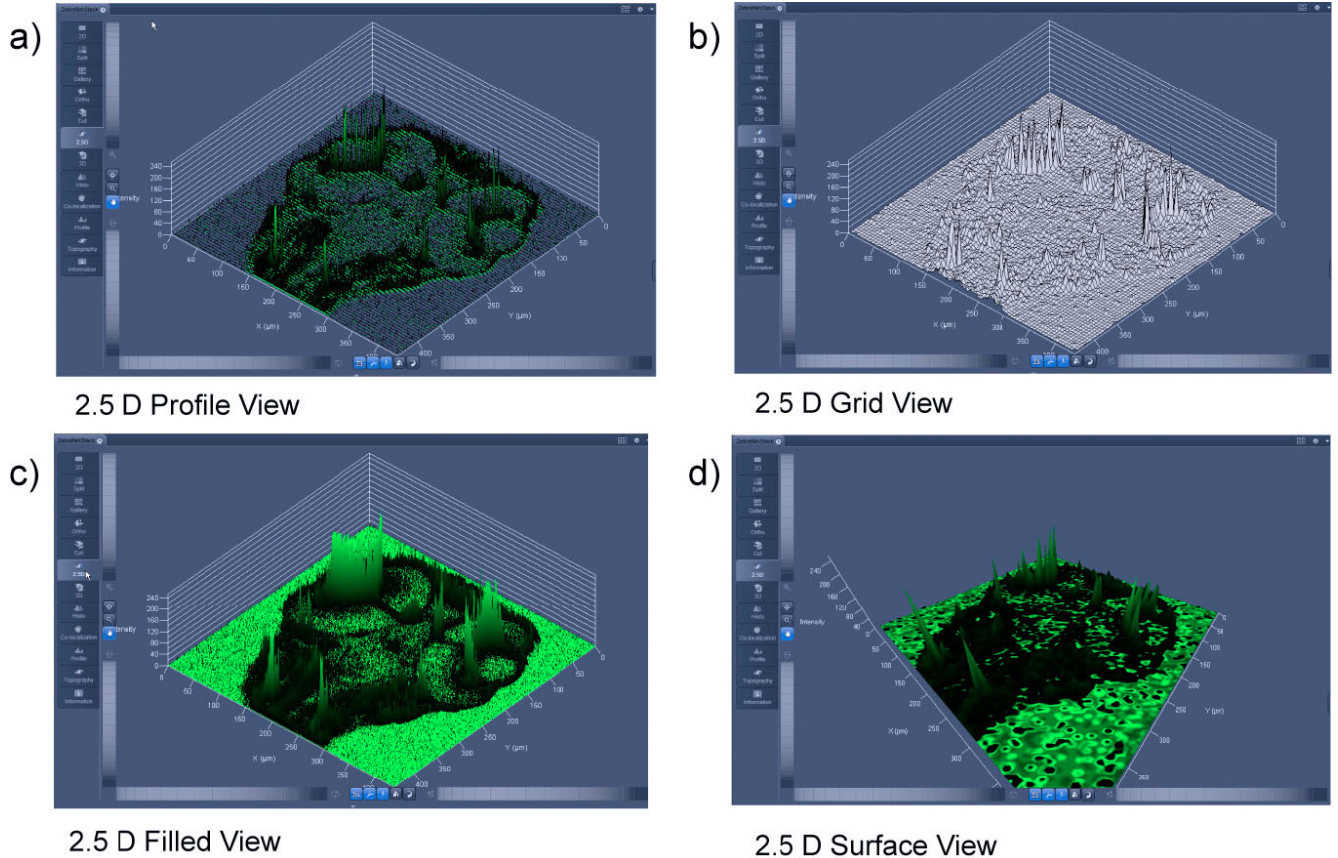


Fig. 196 2.5 D Image Display

The 2.5 D view control tab contains the following function elements:

- Profile** button Profile display (vertical polygon display). Setting of the **Profile Distance** between 1 and 20 using the slider.

- Grid** button Grid display (horizontal grid display). Setting of the **Grid Distance** between 1 and 20 using the slider.

- Filled** button Color diagram (filled 3D diagram). Selection between the **Mono**, **Rainbow** and **Six Step** color palettes.

6.8 3D View (Image VisArtplus)

With Image VisArtplus the Z-Stack of images generated by using the LSM systems can be displayed in three dimensions. Display and rendering of Z-Stacks with up to eight color channels are supported and the data can be a time lapse series (5D Image Stack).

The parameters of the **Channels** (including the selected LUT) set in the **Dimensions** View Options are applied. All other parameters from the **Dimensions, Display, Player** and **Overlay View Option** control blocks are not applied.

A click on **3D** will display the **3D** View Controls. Any changes done within these controls are effective immediately.


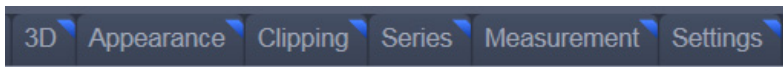
 The **3D** View can also be used online during scanning.



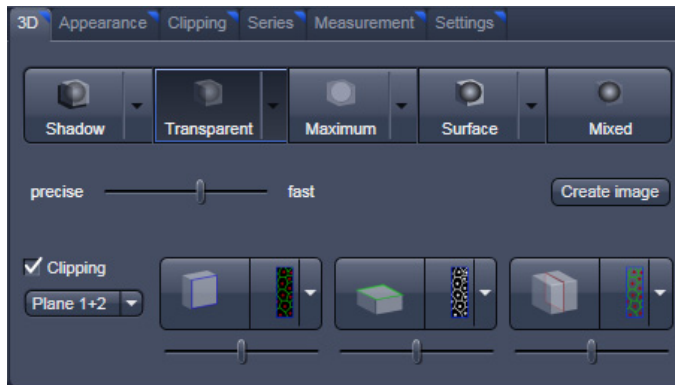
Fig. 197 Image Display window - 3D display

The **3D** view Controls contain the following functional elements:



They are displayed when the tab is pressed in the order shown above.

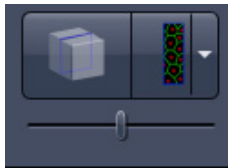
3D:



On the **3D View** control panel the different render modes are accessible:

Shadow, Transparent, Maximum, Surface and **Mixed**. The rendering quality can be adjusted by using the **precise** — **fast** slider. The **Create image** button **Create image** opens a new image window and produces a 2D image of the currently used render mode. It uses the screen resolution unless it is otherwise defined in the **Settings** tab (see there).

Clipping **Clipping** activates the Clipping Plane functionality. 3 different Clipping Planes are displayed and can be operated individually via 3 Buttons:



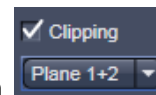
The Cut button toggles between different clipping behaviors of the respective planes.



On the Clipping Planes different surfaces can be chosen from a pull down list:

The Position of the clipping planes can be adjusted by the **Position Slider**.

Further functionality is available on the **Clipping Plane View control tab** → see there.



A wedge between 2 Planes can be clipped using the pull down **Plane 1+2** underneath the activation check box for the clipping functionality.

Appearance:

On this view control panel the settings for the respective render mode are available.

Clipping:

VisArtplus has the option to cut off certain parts of the 3D information by using so called "clipping planes". All the necessary tools to operate the clipping planes are found on this control panel.

Series:

3D Data can be visualized online by simply grabbing and turning the data stack with the mouse. In addition to this interactive way of interacting with the data *VisArtplus* is able to perform render series where the dataset is turned around one of the axis, along a freely defined position list or a freely definable start and end point. The resulting series can be saved as movie files for presentations. A preview of the render series is available in the **position list** mode.

Measurements:

Measurements of distances, angles and polylines can be measured using the **Measure** panel in *VisArtplus*.

Settings:

In the **Settings** panel global settings for the *VisArtplus* Module can be found.



Fig. 198 3D panel - Shadow button

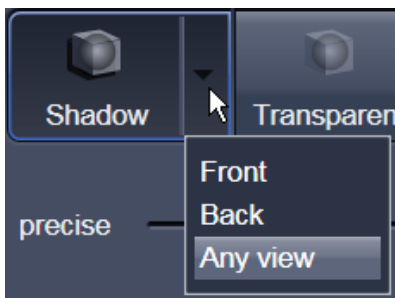


Fig. 199 Shadow pull down menu

6.8.1 Shadow Projection

In the Shadow render mode the structures in the image are illuminated by a virtual light source.

The volume is viewed as if looking through the eyepieces of the microscope and the light source projects a shadow onto a background plane.

This gives the data a reference in space, making visualization much easier. The rendering effect itself consists of a combination of light reflection and opacity (degree of transparency).

The display in this mode is calculated by the main processor (CPU) of the computer (Voxel mode). The different modes can be accessed by clicking on the pull down symbol at the right hand side of the **Shadow** button (Fig. 199).

- **Front** button: Shadow rendering front view
- **Back** button: Shadow rendering back view
- **Any View** button: Shadow rendering with user defined view

With a click on **Front**, the 3D reconstructed image is displayed in a shadow projection where it is illuminated at a 45° angle from the front left.

A click on the **Back** button creates the same projection with illumination from back left.

Detailed settings for shadow projection can be accessed via the **Appearance** tab.

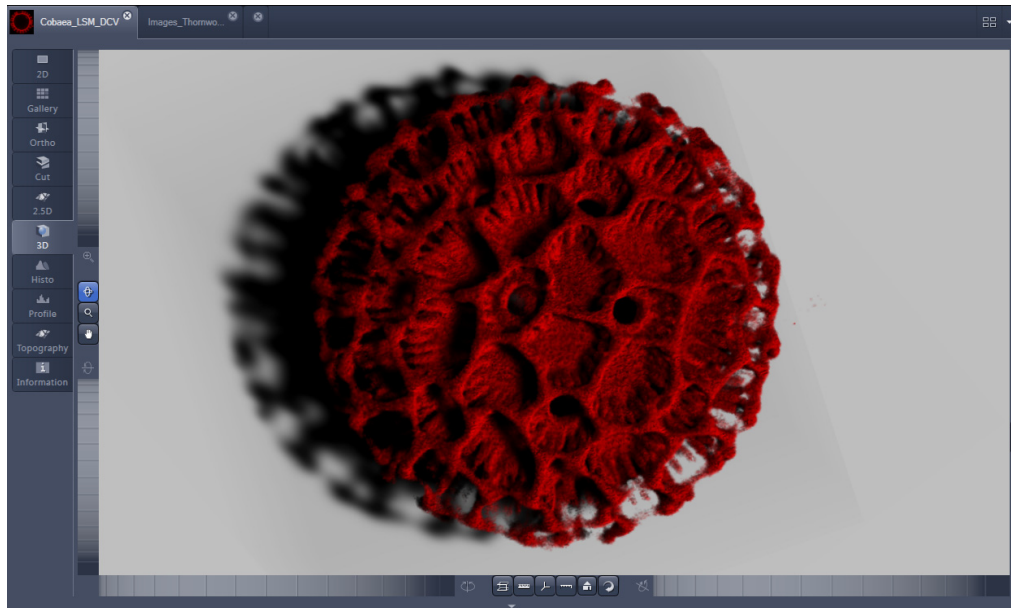


Fig. 200 Image Display window, 3D display, Shadow projection, Front view

The zoom wheel to the left of the **Image Display** window allows continuous zooming of the 3D reconstructed image.

A click on the **Any View** button displays the 3D reconstruction image in a shadow projection where the viewing point can be defined. In addition to the zoom setting, the image can be rotated around the three orthogonal axes via the relevant setting wheels.

However, the 3D orientation can also be set directly in the **Image Display** window by clicking, holding and dragging the 3D reconstructed image with the mouse.

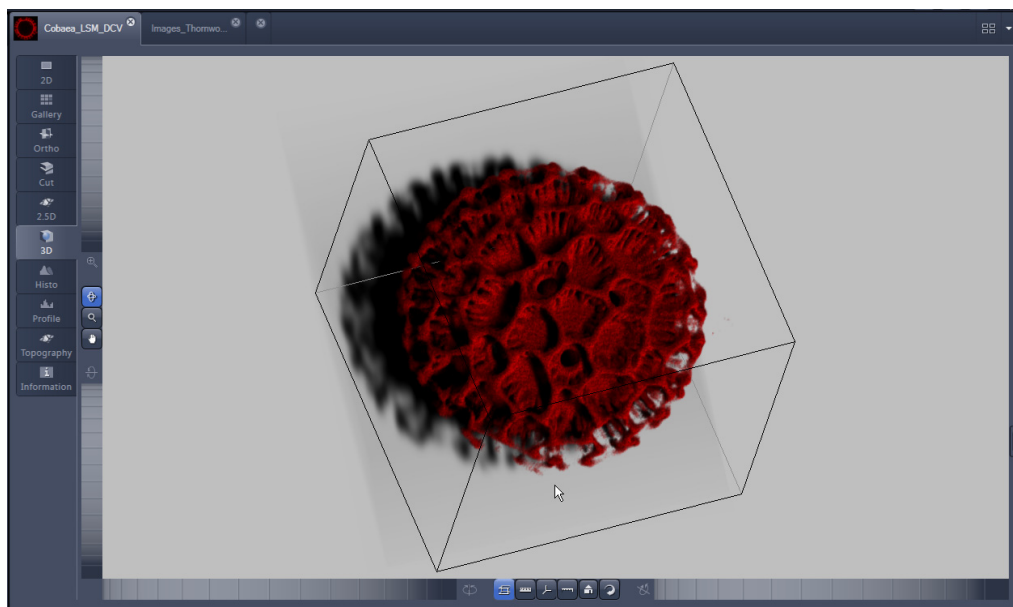







Fig. 201 Image Display window, 3D display, Shadow projection, Any View

The following additional buttons are available in the **Any View** shadow projection mode:




- After activation of the **Frame** button  (below the image), a bounding box is drawn around the 3D reconstructed image.

 Depending on the used mode and hardware configuration, it can take several seconds until the 3D reconstruction is refreshed on the monitor after reorientation.

- A click on the **Coordinate System** button  displays a colored coordinate system in the **Image Display** window, where the X axis is displayed in red color, the Y axis in blue and the Z axis in green.
- A click on the **Scale** button  display an X-, Y- and Z-scale in the **Image Display** window.
- A click on the **Home** button  resets the display parameters to the default values.

A click on the **Any View** button displays the 3D reconstruction image in a shadow projection where the viewing point can be defined. In addition to the zoom setting, the image can be rotated around the three orthogonal axes via the relevant setting wheels.

However, the 3D orientation can also be set directly in the **Image Display** window by clicking, holding and dragging the 3D reconstructed image with the mouse.

- A click on the **Animation** button  activates the animation mode. The object can be pushed by dragging in the **Image Display** window and rotates continuously. Any new push with pressed left mouse button changes the rotation direction and speed of the animation.

6.8.2 Transparency Render Mode

Principle:

In the **Transparent** mode a three-dimensional image with a transparent effect is calculated. At least two two-dimensional texture stacks (computed from two different angles) are used depending on the volume orientation. In contrast to the Shadow mode the scene here is illuminated by diffuse white light from the rear. By changing the available parameters one can mix different channels and reveal relationships between information in those channels. This view is particularly useful for visualizing the three-dimensional relationships between structures within the volume. This mode can be displayed both in CPU based Voxel mode (**Basic**) and also (with the help of a suitable graphics card) with accelerated calculations in so-called OpenGL mode (**Advanced**).

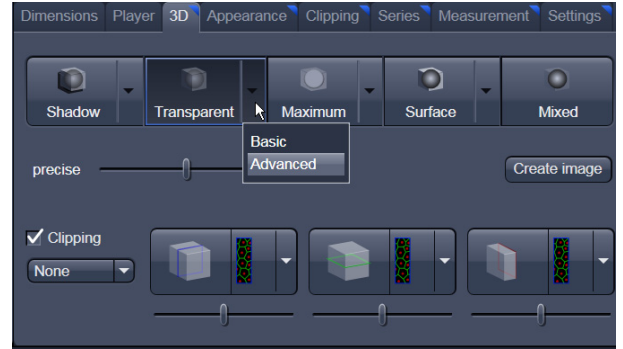


Fig. 202 3D View Control Panel, Transparent

Basic Transparency rendering (voxel based) (CPU)

Advanced Transparency rendering (voxel based) with textures (GPU)

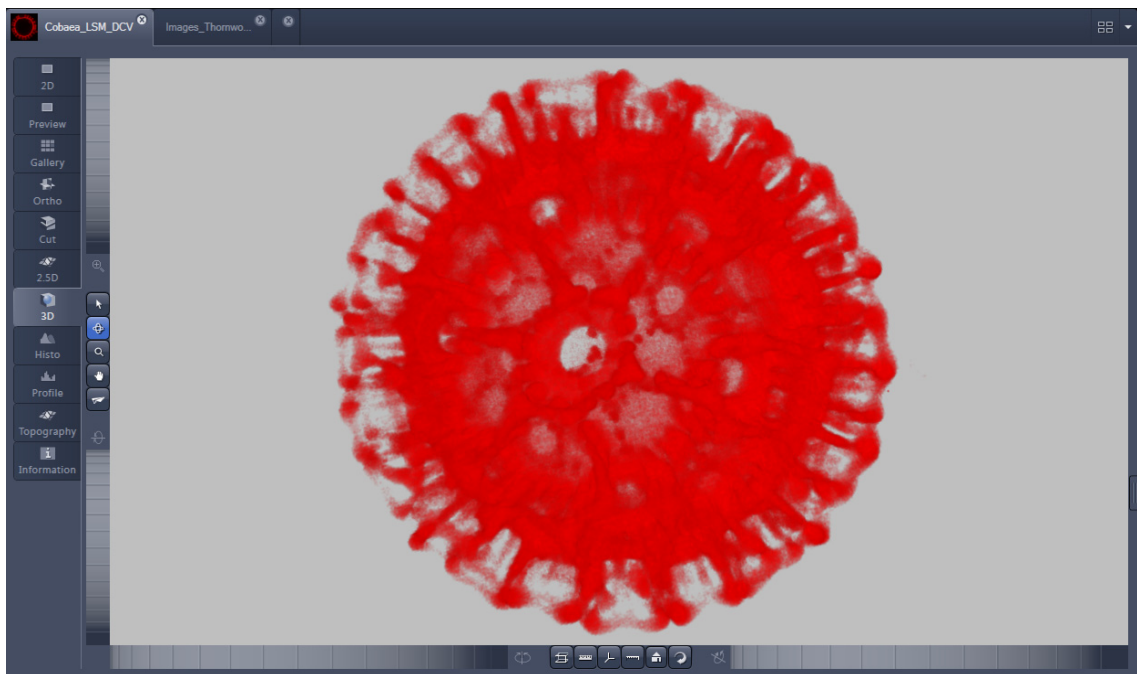


Fig. 203 Image Display window, 3D display, Transparency projection, Advanced

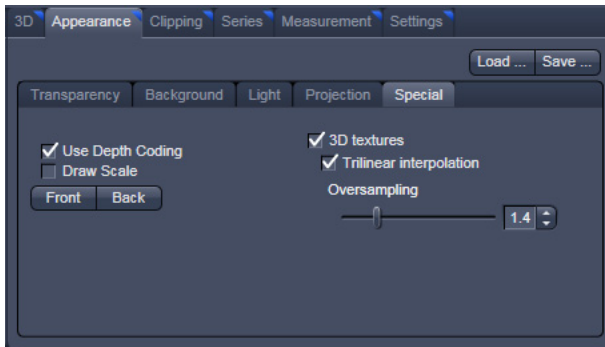



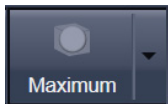
Fig. 204 3D toolbar – Transparent – Depth Coding

By means of the **Depth Coding** function (Fig. 204), the Z-information contained in a sequence can be colored with the colors of the rainbow, in which case "blue" stands for higher values and "red" stands for lower values.


The **3D Textures** option can be used for faster and better rendering of transparency renderings.

 Note that this function is only available in Transparency and Maximum Intensity Render Modes.

6.8.3 Maximum Mode



Clicking on the **Maximum** button switches to **Maximum projection** mode, which calculates a three-dimensional view of the data by only showing pixels of the highest intensity along the projection axis. This view is particularly useful for displaying three-dimensional images in two dimensions, e.g. in publications, and guarantees a maximum possible degree of transparency. The display in this mode can be calculated by the main processor (CPU) of the computer (Maximum basic) or the graphics card (Maximum advanced) in OpenGL mode.

 Note that this is a rendering. If desired 1:1 Maximum Intensity Projections can also be done in the **Processing** tab in **Maximum Intensity Projections** (see section **Maximum Intensity Projection**). With these Images exact Intensity Measurements can be performed.

Maximum Basic Maximum Intensity CPU based

Maximum Advanced Maximum Intensity GPU based

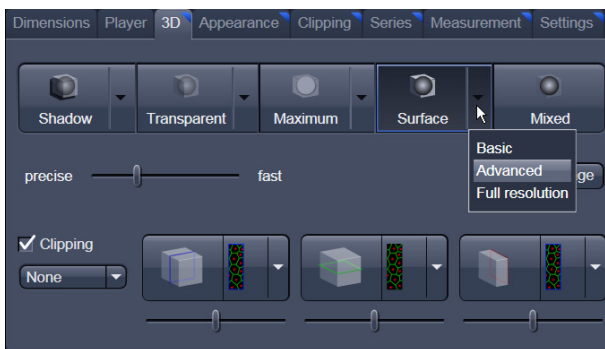


Fig. 205 3D toolbar – Surface

6.8.4 Surface Render Mode

In the **Surface** mode (Fig. 205) grey values in the image are computed as solid surfaces (also known as Iso surfaces) instead of soft transparent shades.

This display mode is useful to focus the attention on certain structures (e.g. plant cell walls, nucleoli, intracellular vesicles) while potentially hiding additional structures deeper within.

In this mode you also can select between Voxel (CPU) [basic] and OpenGL (graphics card) [advanced] display.

The [full resolution] projection is based on a high precision calculation method for 3D information on the basis of triangles with maximum resolution.

- Basic** button Surface rendering (voxel based)
- Advanced** button Surface rendering (triangle based)
- Full Resolution** button High accuracy surface rendering (triangle based)


6.8.5 Mixed Render Mode

In **Mixed** mode both, transparency and surface mode, can be mixed in one volume display.

Using this mode one can render small structures within cells such as vesicles or speckles (e.g. FISH signals) as surfaces in one channel of a multichannel image while rendering the surrounding cytoplasm from another channel in transparency mode.

This way one can also visualize more complex relationships convincingly.

The render mode (**Transparent**, **Surface**, **Surf.+Transp.**) can be chosen per channel.

 The channels can also be switched off individually by de-activating the channels in the **Dimensions** view control panel.

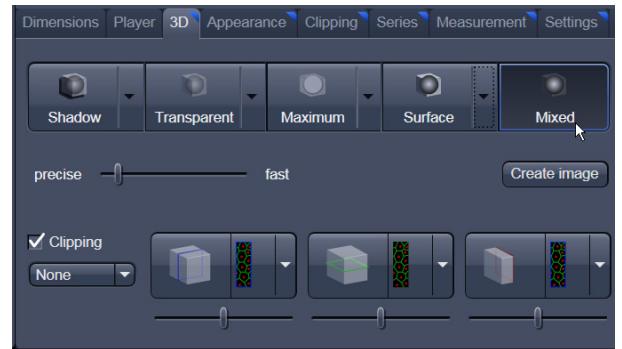


Fig. 206 3D toolbar – Mixed

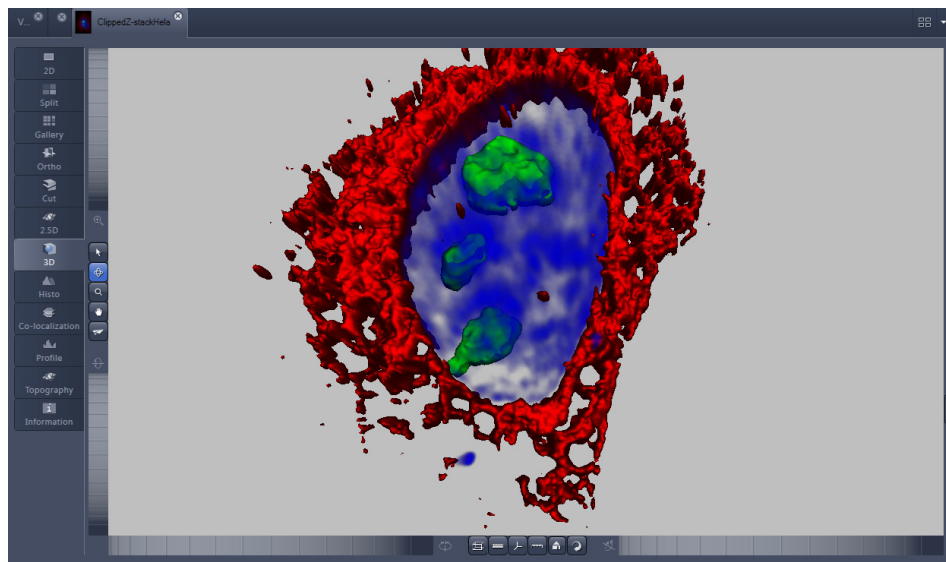


Fig. 207 Image Display window, 3D display, Mixed projection

6.8.6 Clipping Planes

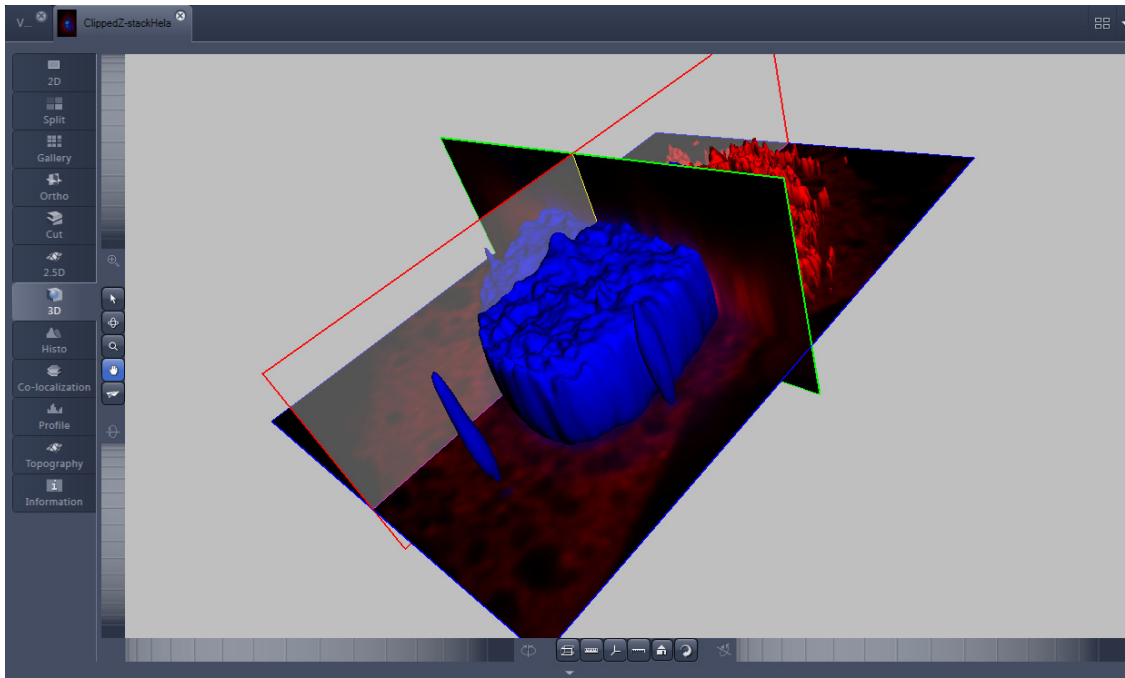
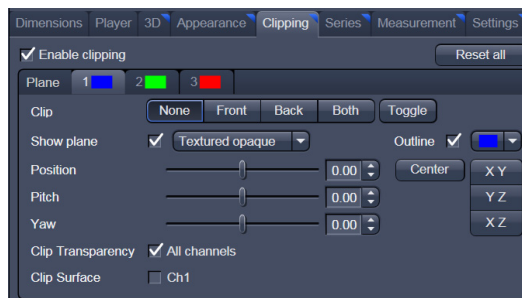
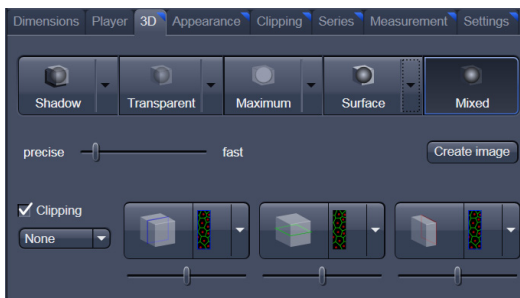


Fig. 208 Image Display window, 3D display, Clipping planes

VisArtplus can display up to three so called **Clipping planes**. These planes can be used to cut the volume open in order to visualize structures which are within a given volume. Clipping planes make most sense when used in the **Surface** and **Mixed** mode but can also be used with limited functionality with the rendering modes **Maximum** and **Transparency** as well as in the Split mode (see below)

The clipping planes can be accessed via the **3D** tab or the **Clipping** tab. On the 3D tab only the most commonly used functionality is available. The full functionality can be accessed on the **Clipping** tab.

 Note that the **Clipping** tab is only available with the **Show all** mode active. 

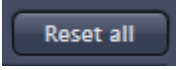


In **Surface** mode clipping planes can be used in a channel specific manner. This means, that in a multichannel image one can selectively cut away portions of the volume in one channel in order to unveil other structures from other channels. This technique is also applicable in **Mixed** mode.

A further possibility is, to use clipping planes in order to display only the grey values of the volume which touch the clipping plane.

All these functions can be used for creating a render series in order to show them and to make spectacular movies for presentations.


There are three clipping planes, which are labeled for ease of use with colored outlines. These outlines do NOT represent the channels. The standard orientations of the planes are **blue**: XY plane, **green**: YZ plane and **red**: XZ plane. This is linked to the default orientation of the volume axis.

Activating the **Clipping** panel displays the clipping planes and displays those with default settings if the image was not opened in the 3D module before.  is setting back the appearance of the planes to the following settings:

- Each plane is placed into the center of the volume and oriented in orthogonal fashion.
- The planes have an opaque surface and colored outlines.
- The clipping functionality of the planes is not activated in this state.

Controlling the clipping functionality of the 3 planes

The clipping planes are operated by three buttons on the **3D** tab which are color coded in the same way the respective planes are color coded. The buttons are located below the **Render Mode Buttons** and can be activated by ticking the **clipping** tick box.

 Note that full functionality of the clipping planes can be found in the **Clipping View Control** tab!

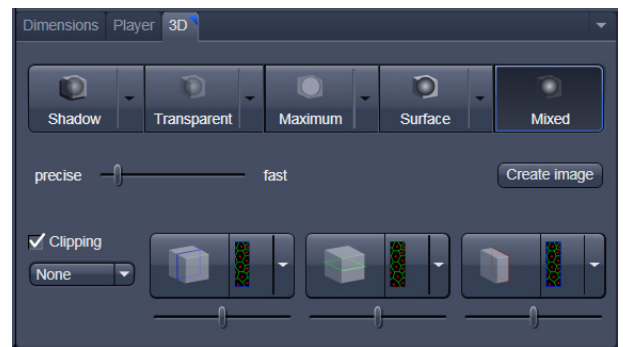







Fig. 209 Toggle buttons

By toggling these



buttons, the clipping behavior of the planes can be set in the following manner:

- **None**: hides the plane completely 
- **Front**: clips away the data on the front side of the plane 
- **Back**: clips away the data on the back side of the plane 
- **Both**: clips away the data on both sides of the plane 
- **Show Plane** only displays the plane – no clipping 

These adjustments can be made individually for each plane. The clipping planes can be chosen by selecting the respective button.

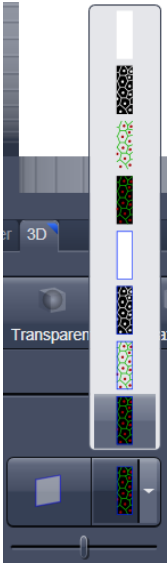



Fig. 210 Clipping planes

Appearance of the clipping planes

By default the clipping planes have an opaque surface and a colored outline. This can be changed by using the dropdown in the **3D** View Control tab. In the **Clipping** View Control tab, this function can be found in a pull down.

 This function is applicable to all 3 clipping planes separately.

Colored:

white - opaque surface of the plane

Binary:

displays the binary data on the clipping planes

Textured:

Data which are touched by the plane are displayed on the clipping plane as in the render mode **Transparent** but as a two-dimensional projection. This does include the settings (threshold, ramp etc) applying for **Transparent** render mode. Black pixels are transparent.

Textured fine:

Same as above but with 4x times the resolution


Transparent:

Data which are touched by the plane are displayed on the clipping plane as in the render mode **Transparent** but as a two-dimensional projection. This does not include the settings applying for **Transparent** render mode. Black pixels are transparent.

Textured opaque:

as with **Transparent** (including the settings) but in this case black pixels are non-transparent, rendered volume data in the background do not shine through.

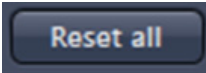
Interactive positioning of the clipping planes

The clipping planes can be moved interactively with the mouse by activating the  button. If hovering over a plane outline of the plane turns into a different color, the cursor turns into a crosshair indicating that the plane can now be moved. Clicking and dragging then moves the plane. The clipping behavior (e.g. "front") is maintained during the movement.

 These movements can also be "recorded" using the render series function.

Clipping Planes Settings

Activate or deactivate the clipping functionality globally by the check box **Enable clipping**.


 displays the three clipping planes in the default mode (opaque surface, colored outlines, clipping planes active, no clipping).

With the **Plane** tabs the planes can be addressed individually and their settings can be adjusted independent from each other.

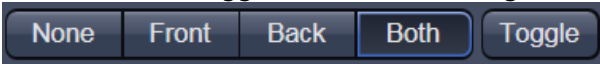
Outline displays or hides the colored outlines. The actual color can be chosen from a color chooser for each plane individually.

Show Plane hides or displays the plane.

 A plane can cut away information whilst being "invisible".

 For distance or angle measurements on a clipping plane the plane has to be displayed and a color has to be chosen for the clipping plane.

The appearance of the plane can be selected from a drop-down menu (see Fig. 210).

Clip names a row of toggle buttons switching between different clipping modes as named on the buttons .

Using the **Pitch**, **Yaw**, and **Position** sliders each plane can be freely orientated in three-dimensional space.

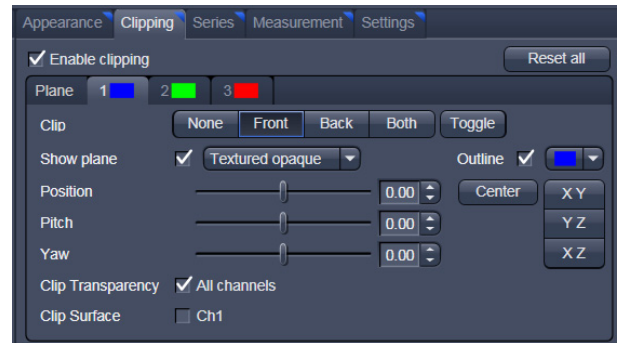


Fig. 211 Clipping planes settings

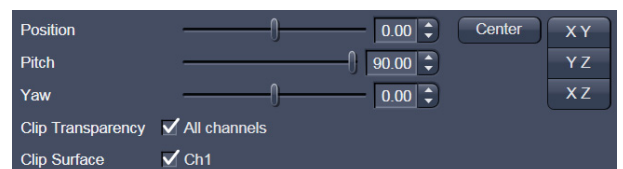




Fig. 212 Sliders Pitch, Yaw and Position

6.8.7 Flying Mode

The **Flying** mode is an interactive way to explore three-dimensional data. By pressing the mouse wheel you can fly into and through a dataset. Moving the mouse left / right and up / down controls the flying direction. Pressing the mouse wheel and the right mouse button at the same time allows for flying backwards.

Once the **Flying** mode is activated, the rotation of the data switches modes: Whereas normally the data turns around an imaginative point in the center of the dataset, in the fly mode the data turns (if moved interactively with the mouse once one stops flying) around an imaginative point "behind" the operator. Pressing the  button switches back into the normal mode.

If a wheel-mouse is not available, pressing the  button turns the left mouse button into the **Flying** button.

The **Flying** mode is only available in graphics card accelerated render modes.

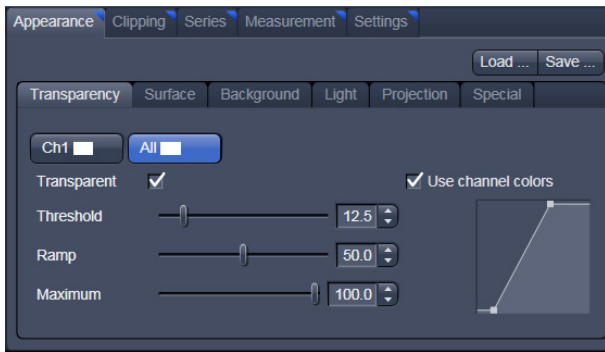
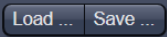


Fig. 213 3D Rendering window (e.g. Surface Advanced rendering mode)

6.8.8 3D Rendering Settings in VisArtplus

Depending on the render mode selected the following adjustments can be applied to the datasets:

All settings can be saved and re-applied to other datasets by using the  buttons.

- **Threshold** specifies a lower threshold as a percentage of the gray values displayed. This decides which data enter the rendered image. If one fluorescence channel contains a homogeneous fluorescence signal with high signal strength, one would set the threshold higher in order to "protect" signals from weaker channels from being quenched.

- **Ambient** describes a diffuse, non-directed light source, which lets both bright and dark structures appear darker or brighter in an equal fashion (values on a scale between 0 and 100).
- **Specular** sets a directional brightness (values on a scale between 0 and 100). Influences the differences between dark and bright structures, which are strongest at a value of 0.
- **Shininess** changes the surface gloss (on a scale between 0 and 100).
- **Ramp** controls the degree of the transition from completely transparent to completely opaque.
- **Maximum** influences the degree of opacity.



The settings are combined into a histogram. The x axis corresponds to the gray values and the y axis to the degree of opacity. You can also use the mouse to interact with the histogram curve.

- **Roughness** (for Shadow mode only): You can also influence the roughness used to display the surface of the image structures. This changes the plasticity of the display (relative scale between 0 and 1). This setting quickly can produce artifacts if pixels reach saturation. The degree of roughness should be reduced accordingly.
- **Brightness** can be controlled via input field or slider bar.
- **Distance** determines the distance between light source and volume. At a value of 0.1 the light source is close by, shadow effects etc. are minimal. The further away the light source, the more prominent the shadow effects become ("evening shadows are longer").
- **Azimuth** describes the angle of the light source above the virtual horizon and can be set by entering values directly or by slider (value range: 0° to 90°).
- **Elongation** describes the horizontal direction of lighting and can be set by entering values directly or by slider (value range: -180° to +180°).

- **Channels:** The settings are entered separately for each channel using sliders or by entering a numerical value in the corresponding input field. To select a channel click on the corresponding button (labeled with the channel color and number).

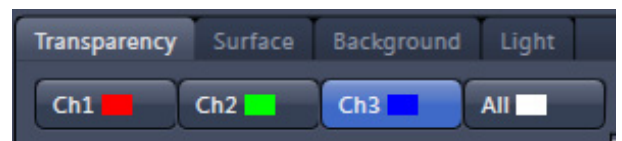



Fig. 214 Channels

- **Distance** (for Shadow mode only) sets the distance between the 3D object and the virtual background on a scale from 0.5 to 3.0.
- **Color:** The color of the background can be freely chosen from a table which appears when clicking the color chooser button .

- **Viewing angle / Scale Z:** In hardware accelerated modes, you can change the projection angle used to view the scene anywhere between 10° and 80°. Use the slider or enter the **Angle** into the input field. The effect of this on the display perspective is similar as if you were viewing the 3D image through a telephoto or wide-angle lens. The Z-Scale of the dataset can be altered interactively by using the slider. The slider ranges from a factor of 0.1 to a factor of 5.

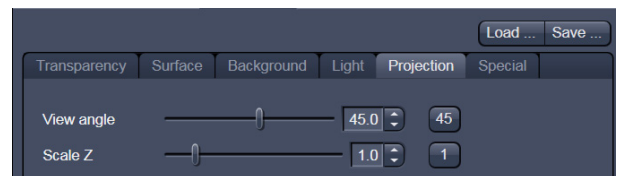


Fig. 215 Viewing angle

- **Background:** The background color can be altered by using the pull down menu. For some 3D Objects it can be beneficial to display a **Structured background** for better orientation within the dataset.

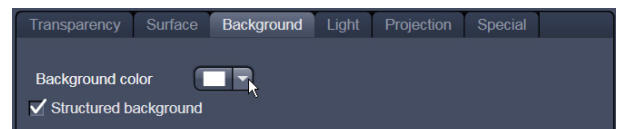


Fig. 216 Background

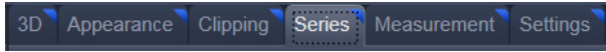


Fig. 217 Series tab

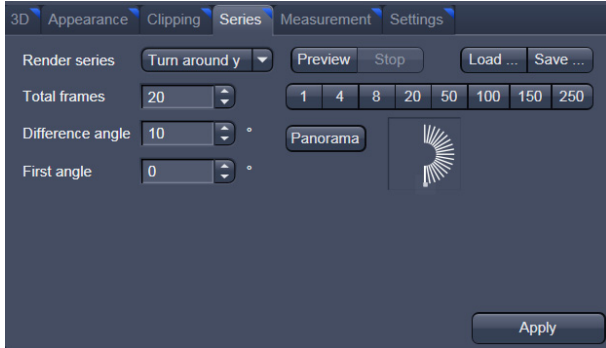


Fig. 218 Render Series window (e.g. Turn around X mode)

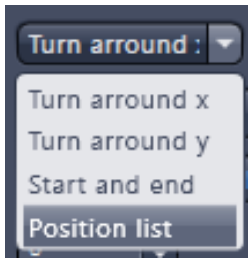


Fig. 219 Render Series modes

6.8.9 Series

The **Series** tab (Fig. 217) displays the **Render Series** control panel. This panel allows settings for the axis to be used for rotation of the 3D reconstructed images. This feature is applicable to all render modes available in *VisArtplus*.

There are four different modes for producing render series (see Fig. 219).

Depending on the activated mode, directly set the parameters for animation in the **Render Series** window and the position of the 3D image in the **Image Display** window (zoom, rotation axes, rendering parameters).

Click on **Apply** to start the animation

The animation is performed in a separate **Image Display** window, which permits the animation to be saved afterwards.

(1) Turn around X and Turn around Y mode

In this mode, the image is turned around the X-axis or the Y-axis exclusively.

The values for **Number of Views**, **Difference Angle** and **First Angle** can be selected accordingly).

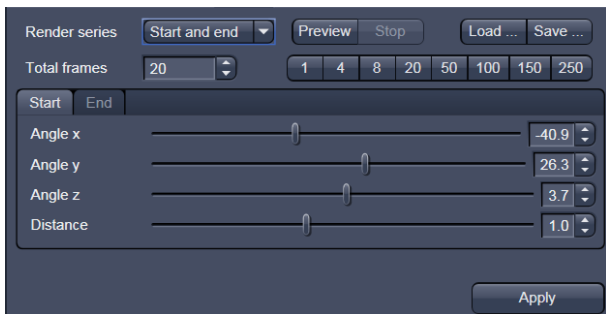


Fig. 220 Start panel in the Render View control block

(2) Start and End mode

In the **Start and End** mode, the image is reconstructed between a start position and an end position.

The rotation angles for X, Y and Z and the distance (zoom) can be determined using the sliders.

The value for **Total frames** can be varied. The frames are distributed equally between the start and end points (Fig. 220).

(3) Position List mode

In the **Position List** mode, the image is reconstructed between any required number of interim positions to be determined individually. Just rotate the reconstructed image with the mouse or do any other adjustment and add this as a "position" in the position list. The module will create a movie using those positions as a guideline. It will interpolate all the parameters ticked in the list.

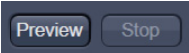
The rotation angles for X, Y and Z and the zoom can be determined directly in the image.

Every required interim position is included in the list of the **Render Series** window with a click on the **Add** button.

Remove permits the contents of the list to be deleted. **Insert** inserts a position above the highlighted list entry.

The value for **Total frames** can be varied. A value of 20 produces a render series with 20 frames in total.

Interpolate lists variables that are interpolated during the Render Series.

Pressing the  button creates a short and low resolution (no interpolation!) preview of the rendering using the positions currently in the list. This serves as a help to quickly review the rendering without actually starting the process (which might be time consuming in cases of long position lists).

Click on the **Apply** button calculates a spline along all the defined positions from the list and starts an animation along this spline track in space.



Fig. 221 **Render Series window - Position List mode**

6.8.10 Interactive Measurements

VisArt plus features three tools for interactive measurements in Euclidian space. Measurements can be performed in all graphic-card accelerated modes (**Transparency**, **Surface**, **Maximum** and **Mixed**). The measured tools are shown as shapes in the rendered volume and can be changed there interactively. Measurement values can be exported as a table to the clipboard for downstream processing in other programs.

First a suitable tool has to be chosen. In order for measurements to work, the mouse cursor must "recognize" a structure. In the **Surface** mode this is a uniquely identifiable surface structure, for the transparent modes the tools look for the highest local gray level maximum.

As a sign, that the mouse cursor has "found" a structure, the cursor shape changes from  into .

The found measurement point is drawn as a blue circle .

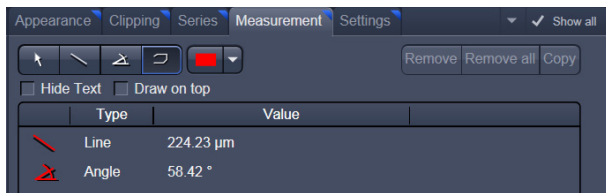


Fig. 222 3D Measurement View control block

Interactive 3D-Measurement

The measurement dialog contains a toolbar with the available measurement tools.

The **Line** tool measures the length along a line in μm . First click on a starting point and move the mouse to the desired end point while keeping the left mouse key depressed. The measurement is concluded upon releasing the left mouse key.

The **Angle** measurement tool defines an angle between two connected line segments. First define the starting point by clicking, and then draw the first line segment until you click on the first endpoint. Now draw the second line segment and conclude the measurement by clicking onto the second end point. This measures the angle in degree.

The **Curve** tool measures the total length (μm) along a variable multi-segmented polygon line. Please click from point to point and finish the measurement by clicking with the right mouse key.

Measurement values are compiled in a list. In order to delete a measurement, select it in the list and press the **Remove** button. One can also delete all measurements by clicking on **Remove all**.

The measurements can be copied into the clipboard with the **Copy** button.

Measurements are only transiently drawn into the volume and are not stored automatically with the image.

6.8.11 Settings

Flying mode

Ticking the tick box **Flying** mode activates the mode, unticking deactivates it.

To show or hide an overview image tick the **Show overlay image** box.

The fly-speed can be adjusted in a range from 1 to 100.

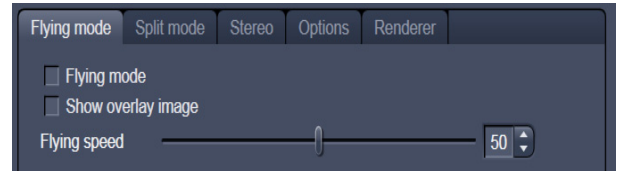


Fig. 223 3D Renderer Settings – Flying mode

Split Mode

Ticking this tick box activates a channel wise 3D split view of the data. This is only available in surface render mode only. An overview image with all channels combined can be shown optionally by ticking **Draw combined image**.

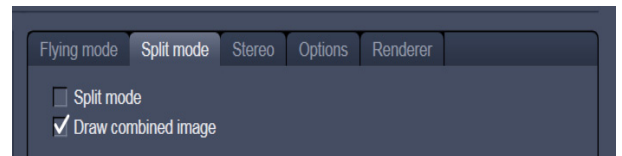


Fig. 224 3D Renderer Settings – Split mode

Stereo

Two Stereo views can be chosen from this sub-menu:

Anaglyph is a view in which the data can be examined in 3D using red/green glasses. The image is built up twice (once each for the red and green colors), resulting in a stereoscopic image.

The stereoscopic effect can only be seen with the aid of red/green 3D goggles. The red lens is to be used for the right eye and the green lens for the left eye.

Camera offset: Defines the distance of both cameras from each other (units in meters).

Parallax shift: Determines the degree of shift which is necessary to correlate both camera views. The slider should be adjusted to maximize the stereo effect. Please note, that this setting will be different for each observer.

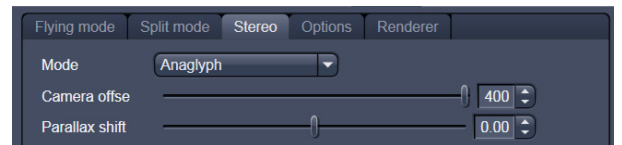


Fig. 225 3D Renderer Settings – Stereo

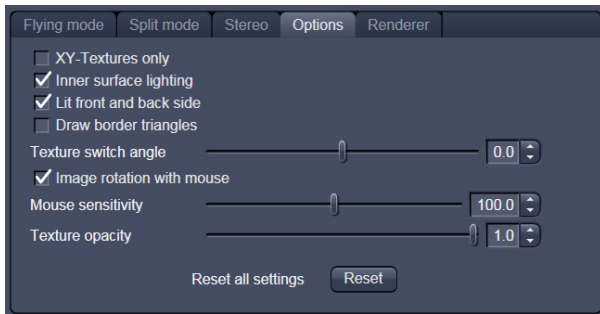


Fig. 226 3D Renderer Settings – Options

6.8.12 Options

XY Textures only: Instead of working with three texture stacks per dataset in transparent render mode, the system will only use one texture stack. This will result in faster renderings. Looking at the dataset from aside although will make the individual z-planes visible.

Inner surface lighting: If checked, illuminates the inside of a surface rendered volume. If unchecked, the inside is dark. If one views the inside of a volume by flying or zooming into it, the inside illumination is helpful. This option is only available for the **Surface** mode.

Lit front and back side: With activated **Inner surface lighting**, this check box colors the inside lighting with a bluish hue. This makes distinguishing inside from outside easier. This option is only available for the **Surface** mode.

Draw border triangles: When displaying the data touching the six sides ("borders") of the Z-Stack in 3D, the triangles used to do this are all located in one plane and orientation. This can cause artifacts, therefore the display of those border triangles can be switched off.

Texture switch angle: This parameter influences the volume angle, upon which the next set of 2D-Textures will be loaded into the graphics card (value range 1 to 100 degree). Depending on the object orientation, the number of z-slices and the chosen render settings this loading process can be visible and may be disturbing especially when rendering a series for movie export. Changing this angle can postpone or even avoid this switch during a series rendering. This option is only available for **Transparency** and **Maximum** modes.

Image Rotation with mouse: Activates a method to rotate the dataset interactively with the mouse. In addition to rotating it freely, when clicking and dragging at the sides of the image window the dragging rotates the data around one axis only. Just like the wheels on the 3D window frame.

Mouse Sensitivity: Influences the mouse sensitivity (value range: 1 to 200). Small values make the mouse actions precise but slow, large values less precise but faster.

Texture Opacity: With this slider the α -values of the dataset can be adjusted. The rendering is getting more or less transparent using this setting.

Reset: Sets all render settings back to the factory standard settings.

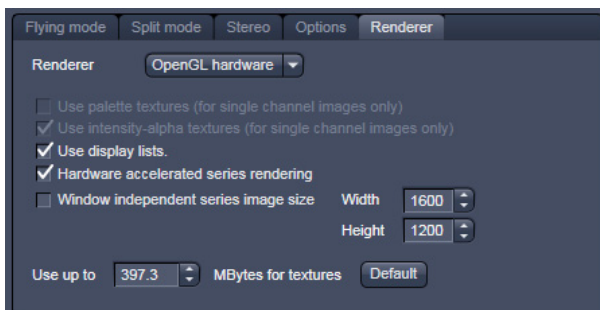


Fig. 227 3D OpenGL Renderer settings

Renderer Options:

Renderer: OpenGL Software is rendering the 3D data with the CPU; OpenGL Hardware uses the Graphics card to do this. Especially when having trouble with non Zeiss-certified graphics cards it is sometimes useful to switch to a pure CPU based rendering.

Palette textures: This feature is an optimization feature not supported by modern graphics cards any more. It used to optimize display of single channel images.

Intensity Alpha textures: This feature optimizes the usage of the graphic ram with single channel images.

Display Lists activates a batch processing of the operations the graphics card is doing. It results in faster rendering.

Hardware accelerated series rendering: Un-ticking this feature uses the Computer Processor for render series. In case of trouble with non-certified graphics cards render series can be performed with the CPU without risk. The use of memory of the graphics card can be adjusted in a dialog box.

Window independent series image size: Using this feature creates render series (see section **Series**) with the output size indicated in the two input boxes. The maximal resolution is 4096 x 4096 pixels. This feature is available in all Render Modes (CPU and GPU accelerated). This applies also to the "**Create Image**" button on the **3D View Options** tab.

Allocate Graphics Card RAM: The amount of Graphics card RAM can be freely defined in the last Item on the **3D | Settings** view control panel. **Default** sets this value to ~ 80 % of the available RAM of the currently used graphics card.

6.8.13 3D View – Basic

Without an active license for VisArtplus ZEN offers the following 3D functionality:

The available basic 3D options are described in section **3D View (Image VisArtplus)**. The following features are available:

- Shadow view - Front view,
- Transparency render mode - Basic, rotate around x or y render series,
- Maximum brightness projection – Basic Mode only, only rotate around x or y, or start to end movies,
- Surface - Basic Render Mode, rotate around x or y movies,
- Stereo Anaglyph Mode.

6.9 Histogram View

The **Histogram** function (**Histo View**) allows to

- display a histogram (distribution of pixel intensities) of an image or Region of Interest,
- show the histogram values in table form,
- copy table to clipboard or save as text file,
- measure area and mean gray value and standard distribution in an area.

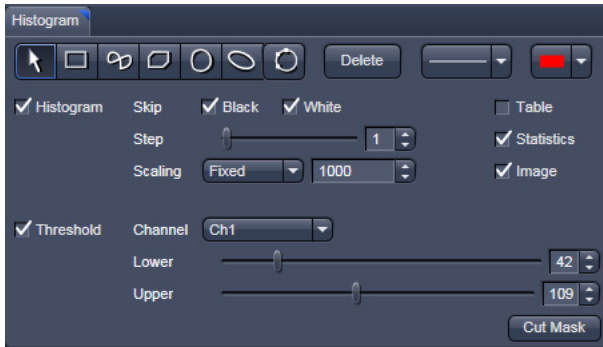


Fig. 228 View Option control block - Histo View

The settings of the **Dimensions**, **Display**, **Player** and **Overlay** view options control blocks apply. The additional view-specific **Histo View Option** control block is shown in Fig. 228.

Any changes done with this View Option control block are effective immediately.

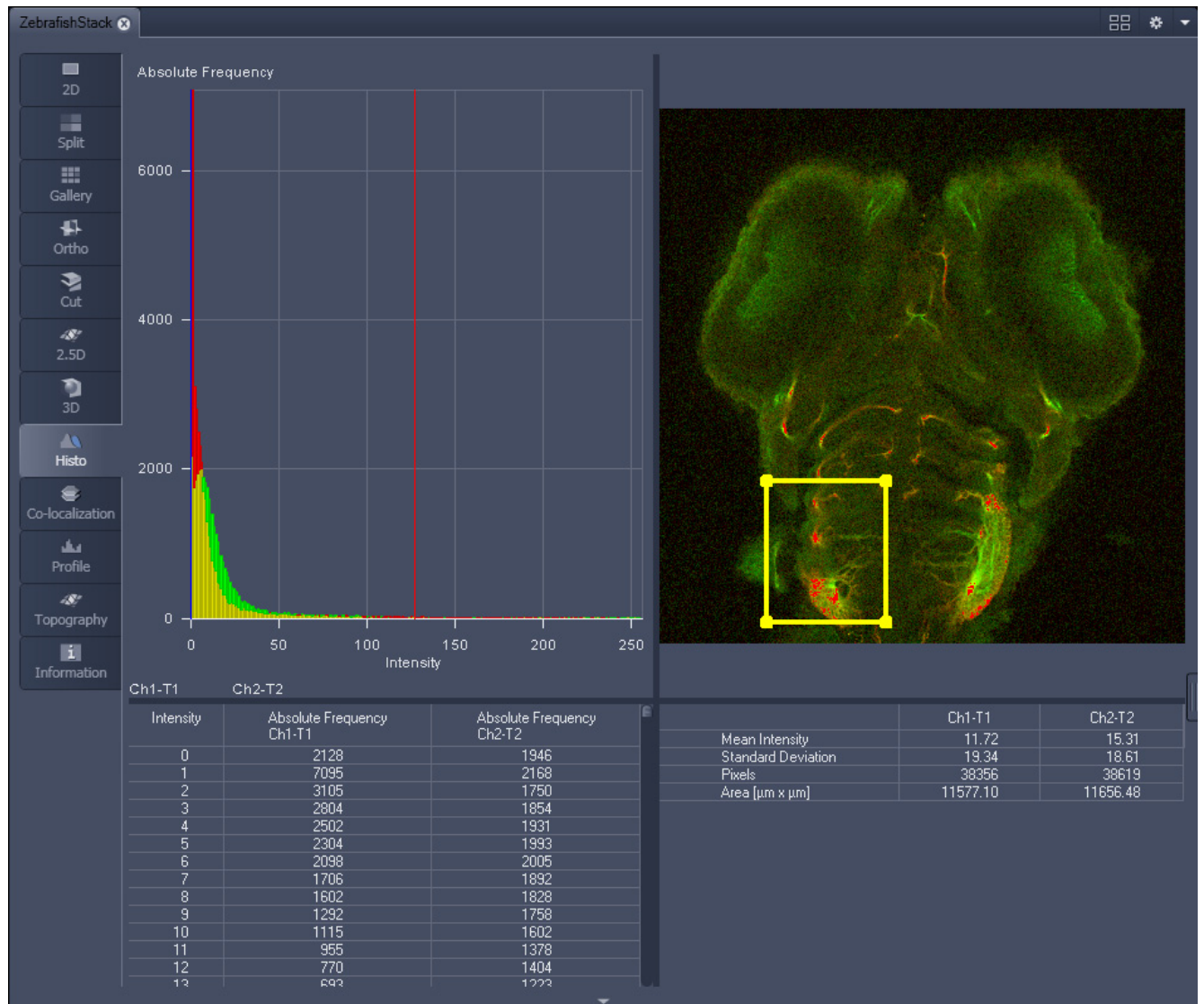


Fig. 229 Image Display, Histogram view

 The **Histo** button can also be used online during scanning.

Histogram functions:



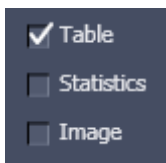
Skip Black and **Skip White** tick boxes: Ignore black pixels (gray value 0) and ignore white pixels (gray value 255 or 4096) in the histogram.



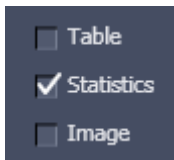
Step slider and spin box: Sets the number of intensity steps ("trays") of the histogram display. Step 1 corresponds to 256 intensity steps, Step 64 to 4 intensity steps (for 8 bit images). Reduction is made by averaging.



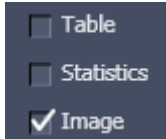
Scaling pull down menu: Sets the histogram graph scaling to either dynamic (adjusting to the maximum value) or fixed



Show Table tick box: A table of the intensity values is shown in the **Image Display** window.




Show Statistics tick box: Displays statistical parameters (Mean Intensity, Standard Deviation, Number of Pixels and Size of Area) in an additional table. Area measurements of very small areas (<10 pixels) give only approximate values.



Show Image tick box: Shows the image in the **Image Display** window with the histogram graph.



The **Cut Mask** tool creates a new image document which sets every pixel outside ROIs to Zero. Within the ROIs, only the pixels with values between lower and upper threshold are transferred to the new image.

 Tables can always be saved or copied to the clipboard by right-mouse clicking on the table display!

Histogram functions and Overlays:

The functionality of the **Overlay View Option** control block fully applies to the **Histo View** Type. If a ROI is marked/selected in the Histo View Image display, only this ROI will be taken into account for the histogram display, the table and the statistics. If there are several ROIs, but none is marked/selected, the histogram display, the table and the statistics analyze all the pixels included in all ROIs.

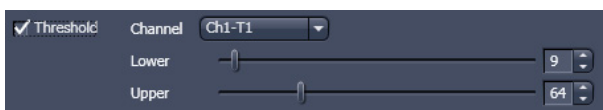


Fig. 230 Histo View Option control block - Threshold

Histogram Threshold:

When the **Threshold** tick box is selected, the controls to set a lower and upper threshold for the histogram calculation are displayed (Fig. 230). The threshold can be set for each channel (channel selection pull down menu).

6.10 Colocalization View

The **Colocalization** function permits interactive analysis of two channels of an image by computing a scatter diagram (co-localization).

The settings of the **Dimensions, Display, Player** and **Overlay** view options control blocks apply. The additional view-specific **Colocalization View Option** control block is shown in Fig. 231.

Any changes done with this View Option control block are effective immediately.

The Image Display in the Colocalization View shows 3 panels: the scatter diagram, the data table and the pseudo-colored image display (see Fig. 232 and Fig. 233).



Colocalization is defined by the presence of two or more different molecules at the same location in a specimen. However, in the context of digital imaging, the term colocalization refers to colors emitted by fluorescent molecules detected by the same pixel in the image. It is important to be aware of the fact that colocalization can not be analyzed for fluorophores with similar emission spectra. Accurate colocalization analysis is only possible if the fluorescence emission spectra are well separated between fluorophores and the correct filter sets (or spectral detection bands) are used for data acquisition. If spectral bleed-through artifacts are present because of spectral overlap between the fluorophore emission spectra, or due to the use of incorrect filter sets, colocalization measurements will be meaningless. To avoid this, the fluorophores must be carefully chosen and matched to the excitation laser lines to obtain the maximum excitation efficiency while still maintaining a useful degree of separation between emission wavelengths. The choice of fluorophores is crucial for colocalization analysis.

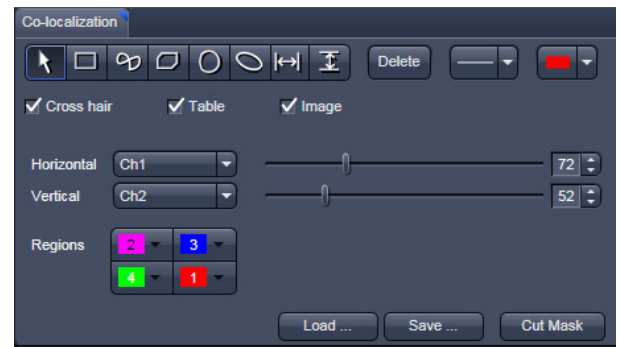


Fig. 231 Colocalization View Option control block

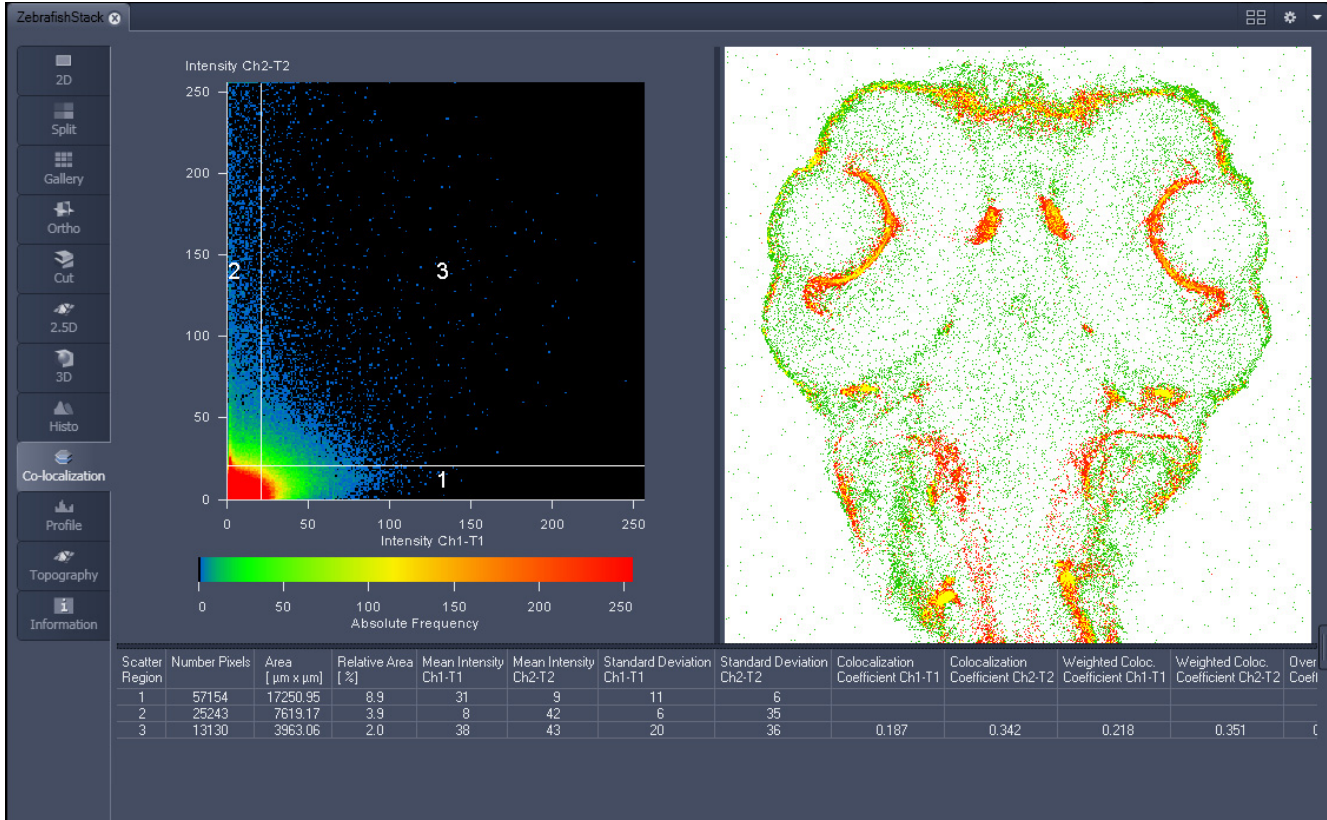


Fig. 232 Image Display, Colocalization view

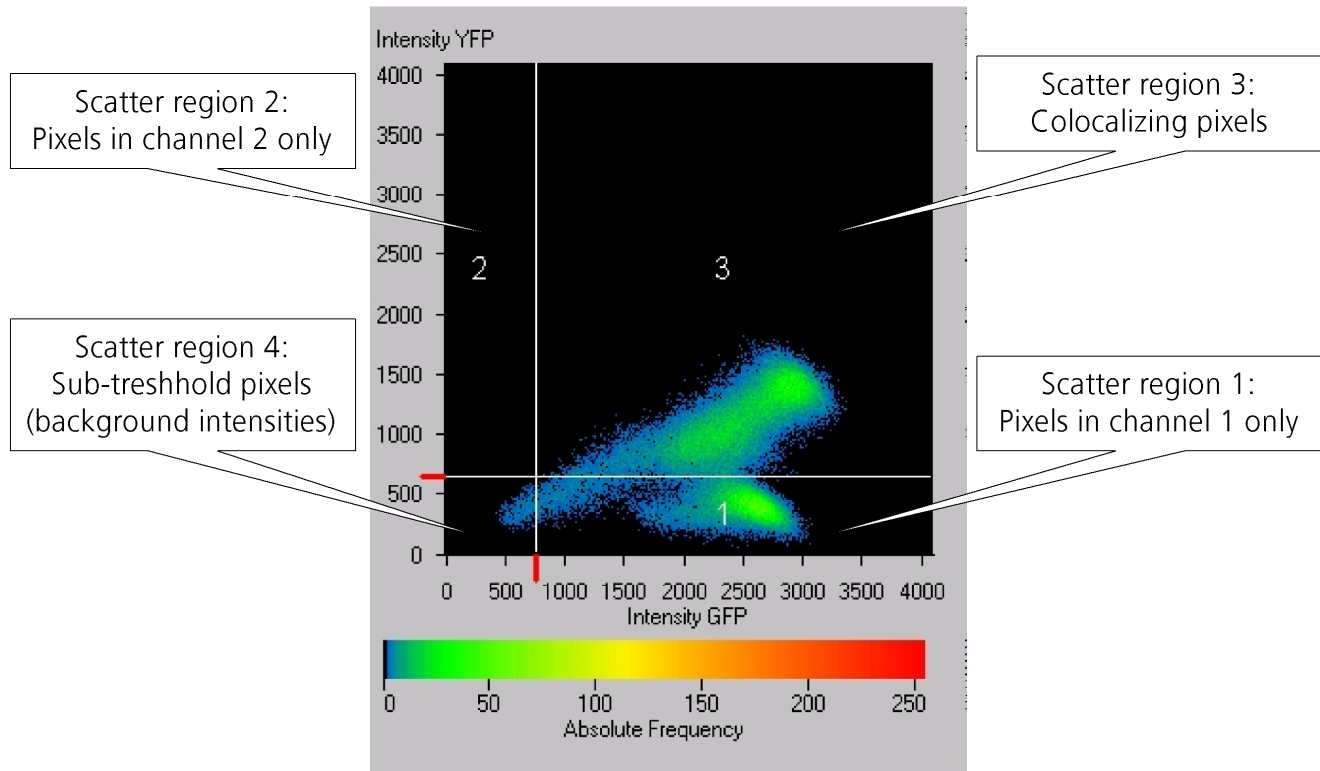



Fig. 233 Scatter diagram and threshold with crosshair

6.10.1 How a Scatter Diagram is Generated

All pixels having the same positions in both images are considered a pair. Of every pair of pixels (P1, P2) from the two source images, the intensity level of pixel P1 is interpreted as X coordinate, and that of pixel P2 as Y coordinate of the scatter diagram. The value of the pixel thus addressed is increased by one every time, up to the maximum number of pixels used. This way, each pixel of the scatter diagram is a value that shows how often a particular pair of pixels has occurred.

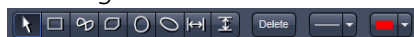
 Differences between the images cause irregular spots in the scatter diagram.

Identical images produce a clean diagonal line running from bottom left to top right, because only pixel pairs (0,0), (1,1), (2,2) with the same intensity can occur. Differences between the images cause an irregular distribution in the scatter diagram.

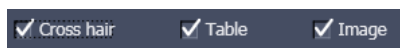
 Scatter diagram, image display and data table are interactively linked and immediately updated when settings are changed.

Available Controls:

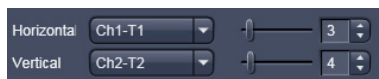
Drawing tools



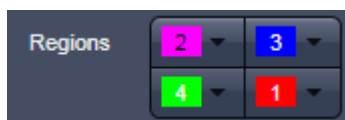
With the drawing tools the colocalization analysis can be restricted to a region of the image. Tools in the Colocalization View Option control block and in the Overlay View Option control block work the same and can be combined.



The Cross hair, Table and Image selection tick boxes: when selected, the respective element is displayed in the Image Display area. If off, the element is hidden.



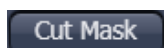
Scaling pull down menu: Sets the histogram graph scaling to either dynamic (adjusting to the maximum value) or fixed




Set the color LUTs for each quadrant in the image display to improve visibility of colocalized pixels.



The Load and Save buttons can be used to save colocalization settings (like color settings for the quadrants and crosshair-positions) to a *.col file and re-load it when analyzing a different data set. This allows using the same parameter for the colocalization analysis of different images.



The Cut Mask tool creates a new image document which sets every pixel outside Quadrant 3 (not colocalized) to Zero. ROIs don't play a role for this Cut Mask function (as opposed to the Cut Mask in Histo View).

 Tables can always be saved or copied to the clipboard by right-mouse clicking on the table display!

6.10.2 Quantitative Colocalization Parameters Shown in the Data Table

- **No. of pixels** in image ROI or scatter region
- **Area / relative area** of image ROI or scatter region
- **Mean intensities / SD** within image ROI or scatter region
- **Colocalization coefficients**
- **Weighted colocalization coefficients**
- **Overlap coefficient** after Manders
- **Correlation coefficients** (R and R²)

6.10.3 Colocalization Coefficients

$$c_1 = \frac{\text{pixels}_{Ch1,coloc}}{\text{pixels}_{Ch1,total}} \quad c_2 = \frac{\text{pixels}_{Ch2,coloc}}{\text{pixels}_{Ch2,total}}$$

- Relative number of colocalizing pixels in channel 1 or 2, respectively, as compared to the total number of pixels above threshold.
- Value range 0 – 1 (0: no colocalization, 1: all pixels colocalize)
- All pixels above background count irrespective of their intensity.

Weighted colocalization coefficients

$$M_1 = \frac{\sum_i Ch1_{i,coloc}}{\sum_i Ch1_{i,total}} \quad M_2 = \frac{\sum_i Ch2_{i,coloc}}{\sum_i Ch2_{i,total}}$$

- Sum of intensities of colocalizing pixels in channel 1 or 2, respectively, as compared to the overall sum of pixel intensities above threshold and in this channel.
- Value range 0 – 1 (0: no colocalization, 1: all pixels colocalize)
- Bright pixels contribute more than faint pixels

Correlation coefficient, Pearson's correlation coefficient

$$R_p = \frac{\sum_i (Ch1_i - Ch1_{aver}) * (Ch2_i - Ch2_{aver})}{\sqrt{\sum_i (Ch1_i - Ch1_{aver})^2 * \sum_i (Ch2_i - Ch2_{aver})^2}}$$

- Provides information on the intensity distribution within the colocalizing region
- Value range -1 to +1
 - 1,+1: all pixels are found on straight line in the scatter diagram
 - 0: pixels in scattergram distribute in a cloud with no preferential direction

6.10.4 Overlap Coefficient, Overlap Coefficient after Manders

(Manders, Verbeek and Aten, J. Microscopy 169:375-382, 1993)

$$r = \frac{\sum_i Ch1_i * Ch2_i}{\sqrt{\sum_i (Ch1_i)^2 * \sum_i (Ch2_i)^2}}$$

- Another parameter used to quantify colocalization in image pairs
- Insensitive to differences in signal intensities between the two channels, photo-bleaching or amplifier settings

Value range 0 – 1 (0: no colocalization, 1:all pixels colocalize)

6.11 Profile View

This function allows to

- display the intensity distribution of an image along a straight or curved line,
- show the intensity values in table form and copy table to clipboard or save as text file,
- show separate profiles for each channel in a multi channel image.

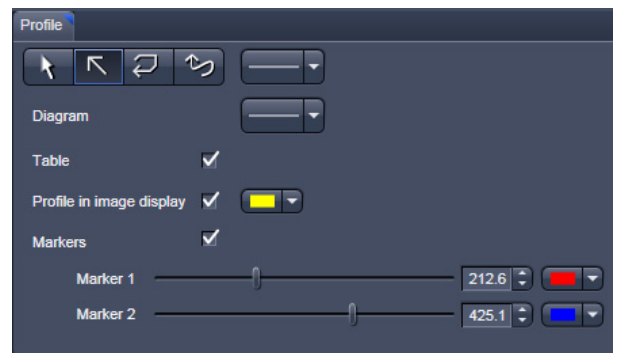


Fig. 234 View Option control block - Profile View

The settings of the **Dimensions**, **Display**, **Player** and **Overlay** view options control blocks apply. The additional view-specific **Profile View Option** control block is shown in Fig. 234.

Any changes done with this View Option control block are effective immediately.

The content of the Overlay plane is temporarily hidden while the toolbar is displayed.

 The **Profile** View can also be used online during scanning.

- Draw a Profile line in the image display to define a profile. The intensity curves are shown in a separate graph (see Fig. 235).
- In the **Profile** View Option control block you can select the width and type of the profile line. The color setting is taken from the **Overlay** View Option control block.
- You can place two markers on the profile line to measure differences in intensities and distances in the XY plane.
- Tick the **Profile in Image Display** block to see an intensity graph superimposed on the image (see Fig. 236).

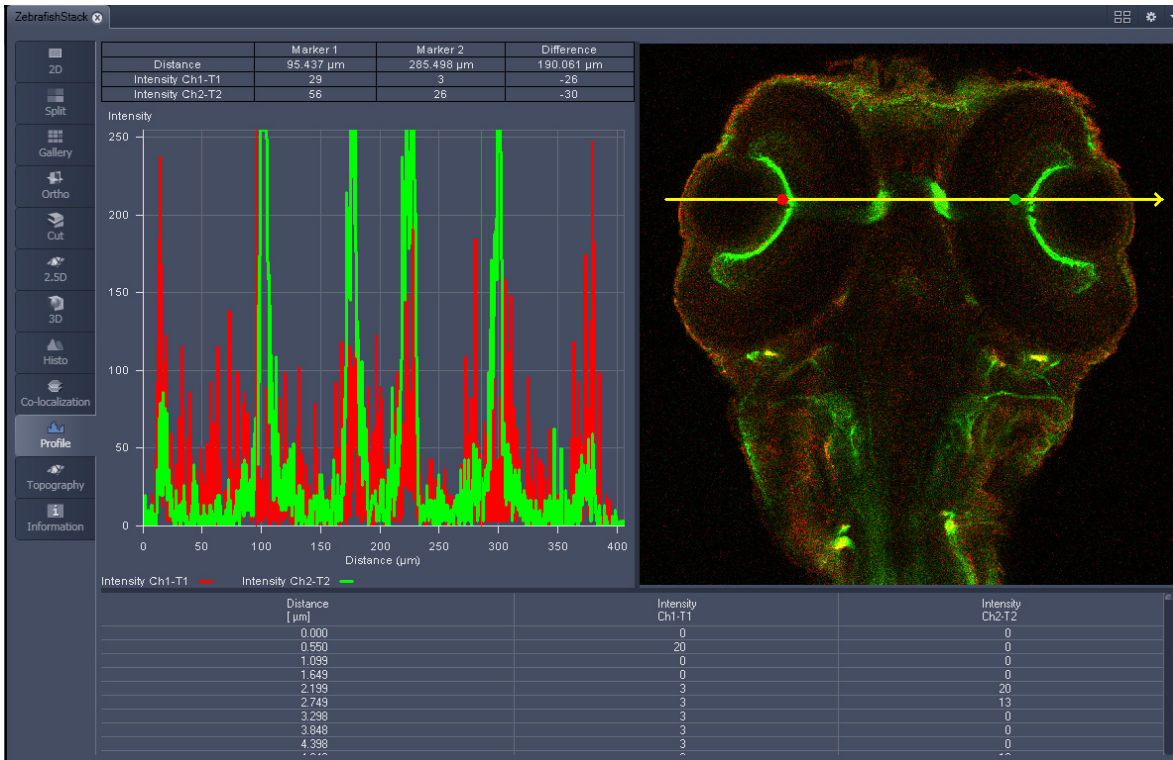


Fig. 235 Image Display - Profile View, Line Profile with markers

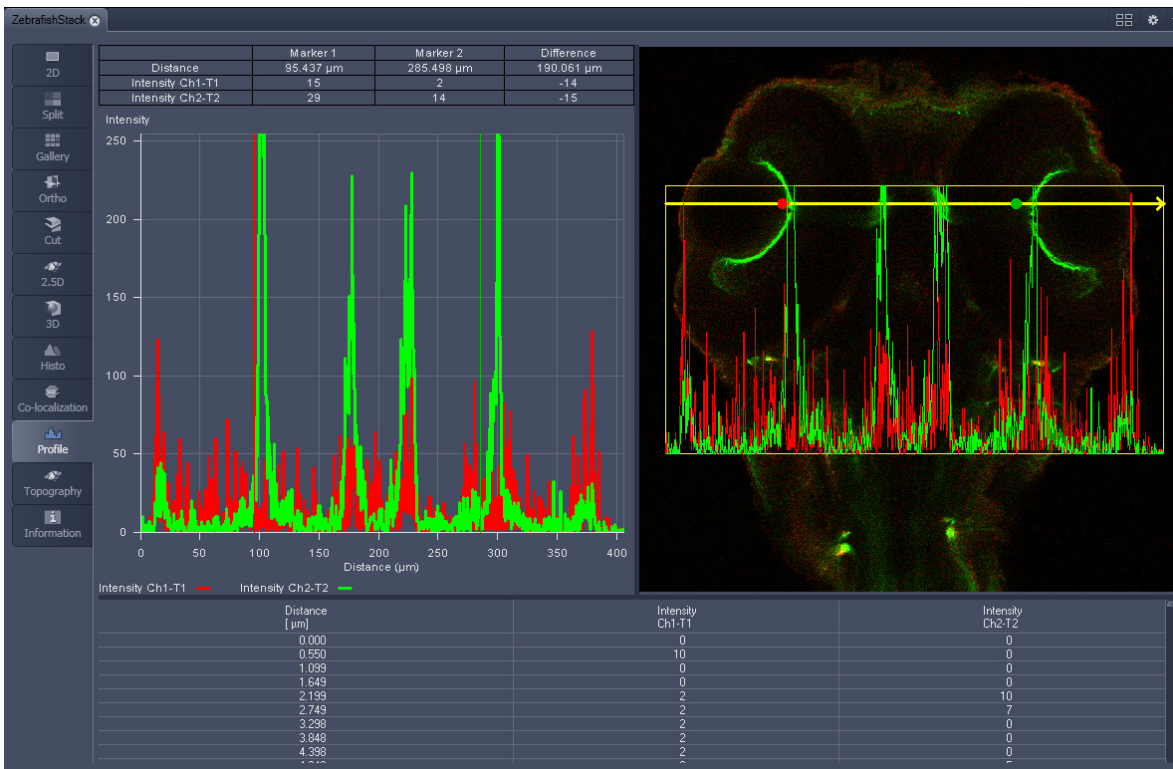


Fig. 236 Image Display - Profile View, Profile displayed in Image

Control block tools

The **Profile** toolbar contains the following tools:



Select button: Activates the mouse button for selection, resizing or movement of the profile line in the **Image Display** window.

Resize: Click on handle and hold down the mouse button, move the handle, release mouse button.

Movement: Click on line and hold down the mouse button, move the entire line, release mouse button.



Line with arrow button: (open arrow): Activates the straight profile drawing mode.

Click into the image and hold the mouse button, drag a line in any direction and release the mouse button to end the procedure.



Open polyline arrow button: Activates the open polyline drawing mode.

The first click into the image sets the starting point, each additional click adds a further line, right mouse click ends the procedure.



Line button: This button allows you to determine the line thickness of the profile line. It has no influence on the way the intensity profile is generated.



Show Table button: The profile diagram is displayed as a table at the bottom of the **Image Display** window.



Tables can always be saved or copied to the clipboard by right-mouse clicking on the table display!

6.12 Topography View

This optional function allows to

- process, display and measure topographic information.
- use frame Z-Stacks
- and frame Z-Stacks over time

The **Topography** function is mainly used for applications in material research and industry.

The settings of **Channels** and **Zoom** of the **2D Dimensions** control block are applied. The **channel color** settings are applied in some 3D display modes. Also the channel for generation of the topography is selected in **2D Dimensions**.

The content of the **2D Overlay** control block is temporarily hidden while the Topography view is displayed.

The topography of a Z-Stack is displayed in the **Center Screen Area**. The parameters used at the last exit of the Topography function are applied.

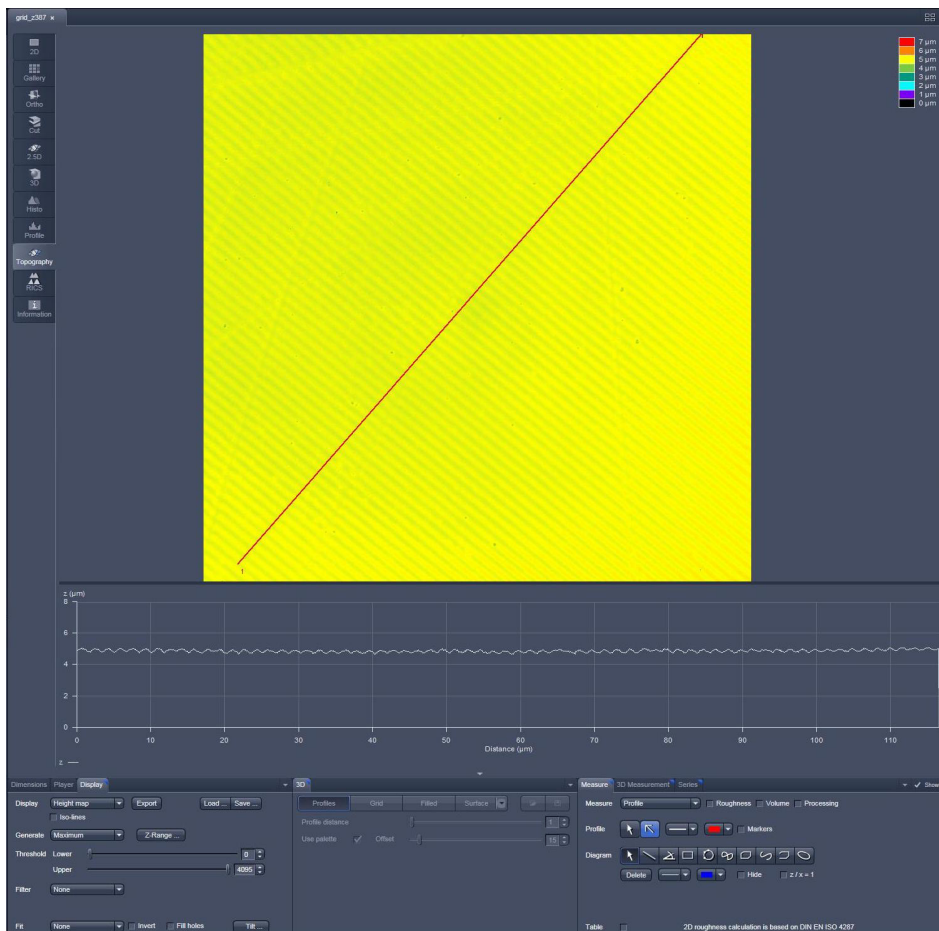


Fig. 237 Center Screen Area, Topography view

The **Topography view** contains the following **image view** control blocks:

Display	Set 2D or 3D, kind of generation, thresholds, filters and fits
3D	Set options of different 3D views.
Measure	Includes all measurement functionality, like profiles, roughness etc.
3D Measurement	Includes additional measurement functionality for 3D views.
Series	Includes different kinds of series generation.

6.12.1 Control Block: Display

- Select **2D (Height map, Maximum intensity)** or **3D**.
 - In case of Height map and Maximum intensity and ticked Iso-lines check box two additional values can be changed:
 - Distance:** Changes the distance of the Iso-lines.
 - Offset:** Setting of the height level where the Iso-Lines display starts.
- Additional settings for 3D are chosen in the 3D-block
- Define the kind of topography generation.
- These views can also be exported as image. Height maps can be exported as lsm-file and later opened by ZEN and used as a topo image. As raw data will be not saved in this kind of export changes of topography as described below can almost not be made any more.

Maximum

- Click on the **Maximum** button to calculate the topography surface by finding the maximum intensity value. If the optical section with the highest intensity value is found, the intensity values of both neighboring slices are also taken into account, so that a 3 point maximum fit is calculated.
- In case it happens, that the maximum possible intensity value is present in more than one optical slice for a given pixel (saturation), the mid section of all saturated intensity slices is chosen as a reasonable approach.

Center

- Click on the **Center** button to calculate the topography surface by using the center of gravity of all summed up intensities of the stack for a given xy print.



This mode provides better result for smooth surfaces of low intensity or nearly transparent surfaces. The receiver gain and offset has to be properly tuned and **MarkFirst-** / **MarkLast-** positions of the stack should be located approximately in the same distance from the real surface.

First / Last maximum

- Click on the **First maximum** button to calculate the topography surface by using the first maximum coming from the top.
- This mode provides better result for surfaces of semitransparent materials with inclusions of higher reflectivity or transparent multilayers with subsurface layers of higher signal intensity.
- Click on the **Last maximum** button to calculate the topography surface by using the last maximum coming from the top.

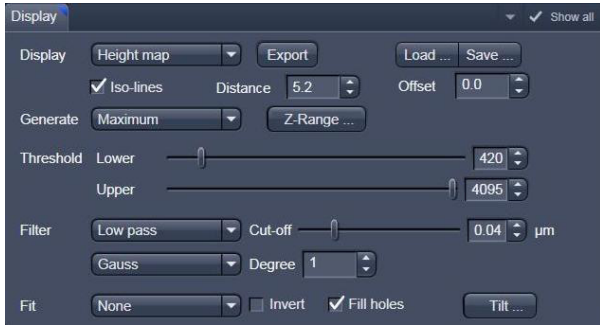


Fig. 238 Image view control block - Display

First / Last threshold

- Click on the **First threshold** button to calculate the topography surface by using the first slice coming from the top, where the intensity reaches the value defined by the lower intensity threshold.

Load / Save gives you the possibility to save / load settings for:

- **Generate,**
- **Threshold,**
- **Filter,**
- **Fit.**



Fig. 239 Z-Range pop up to define height thresholds

- Click on **Z-Range...** to calculate the topography surface by using the lower and the upper height thresholds for image display. Use of this function is recommended to get rid of unwanted peaks and valleys taken into account for parameter calculation. All topographic data with height values less or higher than the thresholds set are ignored for the display and parameter calculation. This threshold applies both for 2D as well as for 3D topography display modes.

- By clicking on the **Peak - valley** button the surface topography is displayed in that way that it is automatically normalized to the lowest and highest Z value of the current 3D topography. Ticking the check box **Automatic** means, that this procedure is continuously performed during further changes, like application of different filters.
- Set the **Threshold** to define the lower and upper intensity thresholds used for calculation of the topography surface. Use of this function is recommended to find the real surface in the case of images with pronounced noise. All image pixels with intensity less or higher than the thresholds set are ignored for the surface calculation.

- Chose a **Filter**:

- **None**
- **Median**
- **Low pass**
- **High pass**

In case of **Low** and **High** pass, **Gauss** and **Butterworth** FFT filters can be chosen below. This function performs a Fast Fourier Transformation (FFT) in the frequency range, applies highpass or lowpass filtering in the frequency range and performs the inverse FFT. Additional **Cut off** and **Degree** should be defined. The **Cut off** frequencies ranges from 1/1000 of the X dimension of the stack to four times of the X dimension of the stack. The dimensions of filtering are given in units of μm . Select a position of the **Degree** slider. The filter functions can be calculated from 1st order to 5th order accuracy.

Changing the topography geometry:

Fit button:

None

Plane: The topography is tilted in such a way that the mean deviation value plane is calculated.

Sphere: A spherical form is eliminated; determination of micro roughness on spherical surfaces can be performed.

Cylinder: A cylinder form is eliminated; determination of micro roughness on cylindrical surfaces can be performed.



You can display the exact values of the **Cylinder / Sphere** fit by ticking the check box **Processing** in the **Measure** block.

A **3-point-tilt** is available using Height map or Maximum intensity with a right mouse click within the image.

Inverse check box:

- Inverse surface. Depths change to heights, and vice versa.

Fill holes check box:

- Intensity of a missing pixel of a hole has to be interpolated by the distance-weighted intensity of all surrounding pixels.
- Fill hole algorithm is optimized for short calculation times.
- Click on **Tilt...** and change **Pitch** and **Yaw** manually.

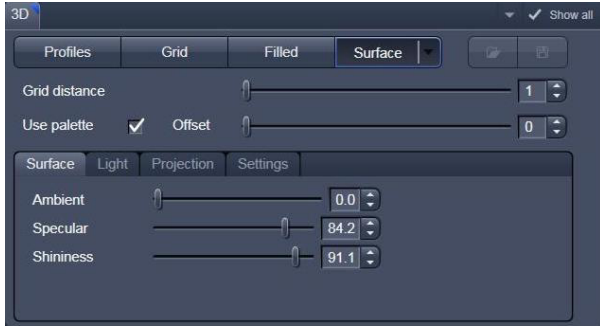


Fig. 240 Image view control block - 3D

6.12.2 Control Block: 3D

If 3D is chosen within the Display block, following settings can be applied in the 3D control block (Fig. 240).

In the first row **Profiles**, **Grid**, **Filled** or **Surface** can be chosen.

Parameters that can be set:

- **Profile distance** slider: Setting of the distance of profiles.
- **Grid distance** slider: Setting of the mesh value of the grid.
- **Offset** slider: Used to push through a color LUT Look Up Table (e.g.: if the **Rainbow 2** is used as channel color)

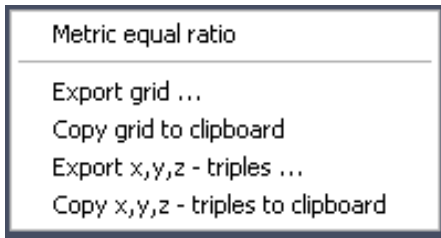


Fig. 241 Context menu using 3D Grid

Using **Profiles** or **Grid**, the Profiles/Grid (x, y, z matrix) and x, y, z-triples (x, y, z table) can be copied to clipboard and exported by a right mouse click (Fig. 241).


 Please make sure that the amount of exportable data is adequate to the maximum importing size of the following software package. To lower the amount of data points, use the profile distance slider.



Fig. 242 Surface renderer items

In case of **Surface** the renderer item can be set, clicking into the right part of the **Surface** button (Fig. 242).

OpenGL - software

The graphics calculation is performed using the installed software.

OpenGL - hardware

The graphics calculation is accelerated by using the installed graphics processor.

Additionally the shading model can be adjusted using the **Surface**, **Light** and **Projection** tabs:

Ambient/Specular: Material properties; how many % of the light component are projected by the material into which spectral ranges.

Shininess: Suitable to specular light. Shininess equal to 25 % determines diffuse light



Fig. 243 Surface renderer: Surface tab

Distance: Suitable to diffuse and **specular**, see visualization.

Azimuth: See visualization. Rise angle of the "sun".

Elongation: See visualization. North-south / east-west direction of the "sun".

Visualization: Ticking the **Draw light source** check box shows you the "sun" within the image tab.

View angle: Determines the perspective, 0.0 degree: parallel projection, else: central projection.

Scale Z: Determines the zoom factor for the Z / height dimension.



Fig. 244 Surface renderer: Light tab

Use display lists: Activates a batch processing of the operations the graphics card is doing. It results in faster rendering.

Use image data as texture: The height data as shown in height map view are used as texture of the 3D model, i. e. only truly measured points are shown.

Scale font size: Sets the font size for the 3D model.

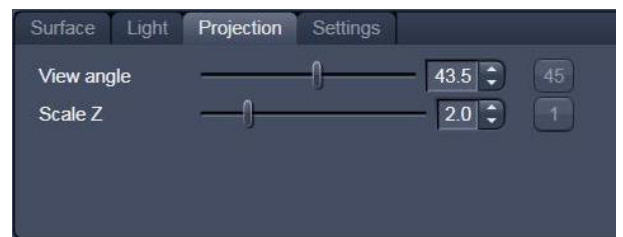


Fig. 245 Surface renderer: Projection tab

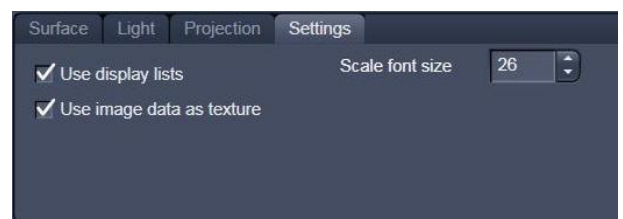




Fig. 246 Surface renderer: Settings tab

Load / Save (see Fig. 240) gives you the possibility to save / load all settings chosen in this block.

The image viewing angle, zoom and axial ratios are set as follows (setting directly in the image):

- Click in the image and hold down the mouse button. The perspective is changed by moving the mouse button in horizontal or vertical direction.

Setting via scrollbars: see section **3D View (Image VisArtplus)**.

-  You can set the x, y and z scales to an identical ratio by opening a context menu in the **Image** with a click of the right mouse button and selecting the **Metric equal ratio** function.
-  The **Profiles** and **Filled** display modes permit a color palette (e.g.: **Glowscale**, **Rainbow** or **User defined**) for the channel to be loaded or redefined.

6.12.3 Control Block: Measure

The topography measurement functions are available in the **Measure** control block (Fig. 247). The measurement functions can be performed in Height map, Maximum intensity and 3D display modes.

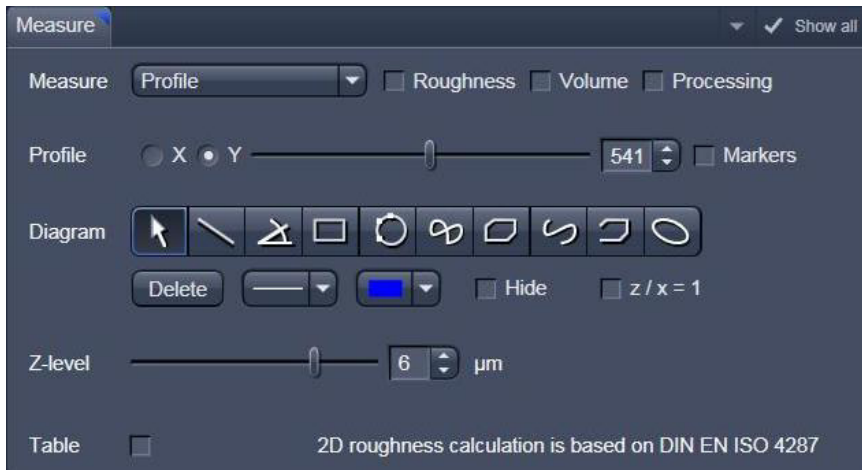


Fig. 247 Image view control block: Measure

Automated convention in height statistics analysis:

Topo Filters	None, median,	FFT High	FFT Low
Data formats	P primary profile	R roughness	W waviness
2D profile	Pxx	Rxx	Wxx
3D topography	PSxx	RSxx	SWxx

The following measurement functions are available in the **Measure** drop down menu:

- **No diagram**
- **Profile**
- **Z-histogram**
- **Bearing area ratio**

Also these check boxes can be ticked, to perform the measurements:

- **Roughness:** Calculation of the roughness parameters
- **Volume:** Calculation of the volume parameters.
- **Processing:** Shows the processing parameters, i. e.:
 - Generation (calculation mode: Max, Center etc.)
 - Threshold (applied intensity threshold)
 - Filter
 - Fit (plane, cylinder / sphere parameters)

6.12.3.1 Profile Measurement

- Chose **Profile** in the **Measure** line.

If **Height map or Maximum intensity** is chosen in the Display block, the following tools are available to set the profile line within the image:



Drag and move a created profile line within the image



Create a profile line within the image



Define the thickness of the profile line within the image



Define the color of the profile line

If **3D** is chosen in the Display block, the following tools are available to set the profile line within the image:





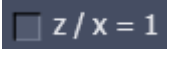
With the slider the profile line can be move on the 3D topography, in X and Y direction.


In order to use **Markers** to measure distances within the profile diagram, tick this check box:



These tools are available for measurements within the profile diagram:

	Move the markers. Zoom within the diagram by clicking the left mouse button, drawing a rectangle around the interesting area, release the left mouse button. To resize the diagram, just click the right mouse button within the diagram field.
	Creation of a straight line . Display of distance, inclination angle, dx/dy and dz. Click and hold down the mouse button, drag the line in any required direction, release the mouse button to end the procedure.
	Creation of a free angle . Display of the enclosed angle (max. 180 °). The first click sets the starting point, the second and third clicks define the angle and the end point.
	Creation of a rectangle . Display of distance, area, height and width. Click and hold down the mouse button, drag the rectangle in any required direction, release the mouse button to end the procedure.
	Creation of a circle . Display of radius and area. Clicking three times to define 3 points on the profile. A circle fit is automatically applied on the profile
	Creation of a closed Bezier figure. Display of the length of the line figure. First click sets the starting point, each further click adds another line, a click with the right mouse button closes the figure and ends the procedure.
	Creation of a closed polyline figure. Display of the perimeter of the figure. First click sets the starting point, each further click adds another line, a click with the right mouse button closes the figure and ends the procedure.
	Creation of an open Bezier figure. Display of the length of the line figure. First click sets the starting point, each further click adds another line, a click with the right mouse button ends the procedure.
	Creation of an open polyline figure. Display of the length of the line figure. First click sets the starting point, any further click adds another line, click with the right mouse button ends the procedure.
	Creation of an ellipse . Display of the area. First click sets the center point, the displayed line permits the determination of the first dimension, second click sets the first dimension, the second dimension and rotation direction can now be determined, third click sets the second dimension and direction and ends the procedure.
	Deletes all drawing elements or the one just selected.
	Change of the line width of the drawing elements.

	<p>Clicking on the Color button opens a color selection box where the color of the drawing element can be selected with a click of the mouse.</p>
	<p>Ticking this box will hide all drawing elements, but not the markers.</p>
	<p>Sets the z/x ratio in the profile diagram to the value 1. Check: the following creation of a circle using the relevant tool really results in a circle in the profile display. Measured angle values correspond to the actual slope of the line displayed.</p>

Tick  in order to see the profile diagram data within a table (below the diagram). A right mouse button click within the table allows to copy and save this table as a text file (ASCII).

6.12.3.2 Z-histogram Measurement

Chose Z-histogram within the Measure dropdown menu. The Z-histogram will be shown as a diagram below the image.


6.12.3.3 Bearing Area Ratio Measurement

Chose Bearing area ratio within the **Measure** dropdown menu. The bearing area ratio diagram will be shown below the image.

Before determination of the top bearing portion, individual peaks (noise, steep slopes) must be eliminated. The **Median** filter or a suitable longpass filter can be used for this purpose.

Shifting the two cursor crosses within the diagram permits two bearing portions to be given in percent (e.g. Smr1 = 10 %; Smr2 = 90 %) as default values for which the height difference Rdc is determined automatically.

6.12.3.4 Roughness Measurement in 2D (Profile) and 3D

- Chose **Profile** in the **Measure** line to get 2D roughness values.
- Tick **Roughness** check box: 
 - The roughness parameters are calculated and displayed on the right side of the image / profile. All roughness parameters calculated from a 2D profile are named with **R**, from the 3D surface **RS**.
 - A right mouse click within the roughness value table permits the roughness parameters to be copied to the clipboard and imported to another program (e.g.: MS Word or MS Excel) via the **Paste** function.

(1) 2D Amplitude parameters (Profile Roughness):

	Mean height z	Rc	Pc	Wc
Dispersion	Arithmetic mean deviation	Ra	Pa	Wa
	Root mean square deviation	Rq	Pq	Wq
Asymmetry	Skewness	Rsk	Psk	Wsk
Sharpness	Kurtosis	Rku	Pku	Wku
Extremes	Highest peak	Rp	Pp	Wp
	Lowest valley	Rv	Pv	Wv
	Absolute peak to valley	Rt	Pt	Wt
	Averaged peak to valley	Rz	Pz	Wz
	Maximum peak to valley	Rmax	Pmax	Wmax
If chosen filters are		FFT High	No, M	FFT L

(2) Calculation of roughness parameters:

The 2D roughness calculation is based on DIN EN ISO 4287. The following roughness parameters are calculated (e.g. for a Y-section)

- Mean height of all profile height values R_c

$$- R_c = \frac{1}{N_y} \cdot \sum_{j=1}^{N_y} \cdot z(x, y_j) \quad N_x, N_y \dots \text{number of pixels in X- or Y-direction}$$

Arithmetic mean deviation of all profile height values R_a

$$- R_a = \frac{1}{N_y} \cdot \sum_{j=1}^{N_y} \cdot [z(x, y_j) - R_c]$$

- Quadratic mean deviation of all profile height values R_q

$$- R_q = \sqrt{\frac{1}{N_y} \cdot \sum_{j=1}^{N_y} \cdot [z(x, y_j) - R_c]^2}$$

- Skewness of the distribution of all profile height values R_{SK}

$$R_{SK} = \frac{1}{N_y \cdot R_q^3} \cdot \sum_{j=1}^{N_y} \cdot z^3(x, y_j)$$

- Kurtosis of the distribution of all profile height values R_{KU}

$$R_{KU} = \frac{1}{N_y \cdot R_q^4} \cdot \sum_{j=1}^{N_y} \cdot z^4(x, y_j)$$

- Maximum peak height R_p

$$R_p = z_{\max} - R_c$$

- Maximum valley depth R_v

$$R_v = R_c - z_{\min}$$

- Maximum roughness depth R_t (= Peak to Valley / PV)

$$- S_t = z_{\max} - z_{\min}$$

maximum height difference of the overall topography along a profile.

- Classification of topography in 5 equal area elements (rectangles in the 2D mode)

- average roughness depth R_z :

$$- R_z = \frac{z_{\max 1} - z_{\min 1} + z_{\max 2} - z_{\min 2} + z_{\max 3} - z_{\min 3} + z_{\max 4} - z_{\min 4} + z_{\max 5} - z_{\min 5}}{5}$$

Averaging of R_t -values of all the 5 single area elements. When combined, both parameters provide information about the homogeneity of the surface. Big differences are indicative of pronounced inclination of the overall area or of spikes.

Developed Surface Area Ratio: Σ (surface area_{ij}) / Σ (projected area_{ij})

The percentage of the 3D surface area (sum off all triangles formed by adjacent data points) to the 2D surface area produced by projecting the 3D surface onto the threshold plane.

- maximum roughness depth R_{max} :

$$- R_{\max} = \text{Max} (z_{\max 1} - z_{\min 1}, z_{\max 2} - z_{\min 2}, z_{\max 3} - z_{\min 3}, z_{\max 4} - z_{\min 4}, z_{\max 5} - z_{\min 5})$$

maximum of R_t -values of all the 25 single area elements.



Both the roughness parameters and the Z-histogram can be changed by using filters!

(3) 3D Amplitude parameters (Topography Roughness):

	Mean height z	RSc	PSc	WSc
Dispersion	Arithmetic mean deviation	RSa	PSa	WSa
	Root mean square deviation	RSq	PSq	WSq
Asymmetry	Skewness	RSsk	PSsk	WSsk
Sharpness	Kurtosis	RSku	PSku	WSku
Extremes	Highest peak	RSp	PSp	WSp
	Lowest valley	RSv	PSv	WSv
	Absolute peak to valley	RSt	PSt	WSt
	Averaged peak to valley	RSz	PSz	WSz
	Maximum peak to valley	RSmax	PSmax	WSmax
If chosen filters are:		FFT High	No, M	FFT L

(4) Calculation of roughness parameters:

The following roughness parameters are calculated:

- Mean height of all surface height values S_c

$$-RS_c = \frac{1}{N_x \cdot N_y} \cdot \sum_{i=1}^{N_x} \cdot \sum_{j=1}^{N_y} \cdot z(x_i, y_j)$$

N_x, N_y ... number of pixels in X- or Y-direction

- Arithmetic mean deviation of all surface height values RS_a

$$-RS_a = \frac{1}{N_x \cdot N_y} \cdot \sum_{i=1}^{N_x} \cdot \sum_{j=1}^{N_y} \cdot [z(x_i, y_j) - RS_c]$$

- Quadratic mean deviation of all surface height values RS_q

$$-RS_q = \sqrt{\frac{1}{N_x \cdot N_y} \cdot \sum_{i=1}^{N_x} \cdot \sum_{j=1}^{N_y} \cdot [z(x_i, y_j) - RS_c]^2}$$

- Skewness of the distribution of all surface height values RS_{SK}

$$RS_{SK} = \frac{1}{N_x \cdot N_y \cdot RS_q^3} \cdot \sum_{i=1}^{N_x} \cdot \sum_{j=1}^{N_y} \cdot z^3(x_i, y_j)$$

- Kurtosis of the distribution of all surface height values S_{KU}

$$RS_{KU} = \frac{1}{N_x \cdot N_y \cdot RS_q^4} \cdot \sum_{i=1}^{N_x} \cdot \sum_{j=1}^{N_y} \cdot z^4(x_i, y_j)$$

- Maximum peak height RS_p

$$RS_p = z_{\max} - RS_c$$

- Maximum valley depth S_v

$$RS_v = RS_c - z_{\min}$$

- Maximum roughness depth RS_t (= Peak to Valley / PV)

$$-RS_t = z_{\max} - z_{\min}$$

maximum height difference of the overall topography.

Classification of topography in 25 equal area elements (rectangles in the 2D mode)

- average roughness depth S_z :

$$-RS_z = \frac{z_{\max 1} - z_{\min 1} + z_{\max 2} - z_{\min 2} + \dots + z_{\max 25} - z_{\min 25}}{25}$$

Averaging of R_t -values of all the 25 single area elements. When combined, both parameters provide information about the homogeneity of the surface. Big differences are indicative of pronounced inclination of the overall area or of spikes.

- maximum roughness depth RS_{\max} :


$$-RS_{\max} = \text{Max} (z_{\max 1} - z_{\min 1}, z_{\max 2} - z_{\min 2}, \dots, z_{\max 25} - z_{\min 25})$$

maximum of R_t -values of all the 25 single area elements.



Both the roughness parameters and the Z-histogram will be influenced by the use of filters!

6.12.3.5 Volume Measurement in 3D

- Tick the check box  within the Measure line:
 - The volume parameters are calculated and displayed to the right of the image.
 - To copy / save the content displayed, click with the right mouse button into the shown tables and decide to copy or save. The values can be imported to other programs (e.g.: MS Word or MS Excel) via the **Paste** function.
- Setting the **Z-level** slider enables you to change the height level of the topography. The portion of the topography lying below the set height level is filled with "water" (blue color) and the volume parameters are calculated online only for the projecting part of the topography.
- ☞ To use the **Z-level** function, load the **Profiles** 3D display mode containing the **GlowScale** or **Grey** channel color to obtain optimum display.
- If the **Measure** function **Bearing area ration** is also activated, a red marker line shows the position of the height level in the percentage of contact area curve.

Within the Volume measurement also the ratio of **valid** data points (means signal intensities within a given intensity threshold) is displayed.

Parameters

The following parameters are calculated:

Z: height level (selectable with the **Z-Threshold** and **Fill Level** sliders). The setting of this value influences the following parameters.

V_m (z): material volume above chosen height level

V_v (z): void volume below chosen height level

S_{mr} (z): material volume ratio

$$S_{mr}(z) = \frac{V_m(z)}{V_m(z_{\min})}$$

S_{vr} (z): void volume ratio

$$S_{vr}(z) = \frac{V_v(z)}{V_v(z_{\max})}$$

A_u: surface bearing area of the topography at Z (= projection area of those parts which are situated above chosen height level)

S_{mr}: surface bearing area ratio of the topography at Z
percentage of contact area (= $A_u / (x * y) * 100 \%$)

Sda: true surface = sum of all triangles formed by adjacent data points of the surface reconstruction

Sdr: developed surface area ratio:

$$\frac{\Sigma (\text{surface area}_{ij}) - \Sigma (\text{projected area}_{ij})}{\Sigma (\text{projected area}_{ij})} * 100 \%$$

$$\text{projected area} = x * y$$

The percentage of the 3D surface area (sum of all triangles formed by adjacent data points of the surface reconstruction) to the 2D surface area produced by projecting the 3D surface onto the threshold plane.

absolute flat surface \Rightarrow is equal to base plane (Sdr = 0 %)

The increase by which the 3D surface is larger than the basic plane (e. g. 625 % is a 3D surface which is about 6.25 times larger than the projected basic plane)

6.12.4 Control Block: 3D Measurement

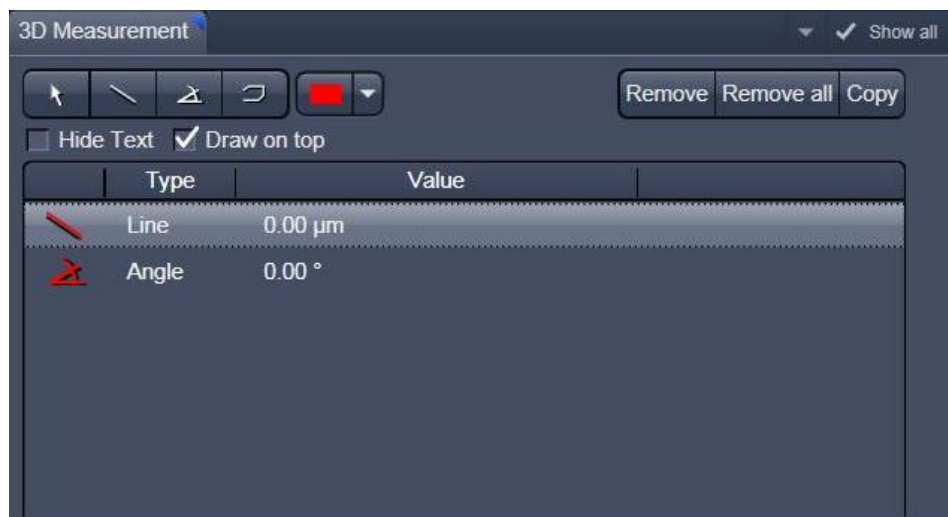


Fig. 248 Image view control block: 3D Measurement

The symbols shown are described in section **Profile Measurement**. These can be used to measure directly on the 3D model. The dimension data shown below can be copied using the "Copy" symbol.

After the open polyline measurement is finished, use a right mouse click to leave the image window.

6.12.5 Control Block: Series

See section **Series** on 3D (VisArt plus).

6.13 Mean of ROI: Additional View Type for Time Series

The **Mean of ROI** View Type allows to

- display the intensity - time diagram (mean intensity in user defined ROIs over time),
- use frame - time series and frame - Z-Stack - time series as input,
- show the intensity values in table form and copy table to clipboard or save as text file.

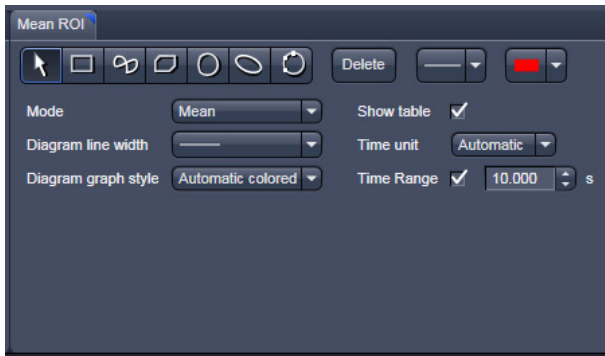


Fig. 249 Mean of ROI View Option control block

The **Mean of ROI** function permits interactive analysis and monitoring intensity over time.

The settings of the **Dimensions, Display, Player** and **Overlay** View Options control blocks apply. The additional view-specific **Mean of ROI View Option** control block is shown in Fig. 249.

Any changes done with this View Option control block are effective immediately.

The Image Display in the Mean of ROI View shows 3 panels: the intensity-over-time diagram, the data table with the intensity values for each ROI over time and the image display with ROIs in overlay (see Fig. 250 and Fig. 251).

To access the **Mean of ROI** View Type, load or acquire a time series data set and click on the **Mean ROI** View tab.

The mean intensity of one or several regions of interest is displayed over time. Time flags from bleaching experiments or trigger events are marked with little symbols on the time-axis of the graph (see Fig. 250).

The **Mean of ROI** analysis always refers to the currently displayed z-section of a Z-Stack (see **Dimension** View Option control block for which section it is).

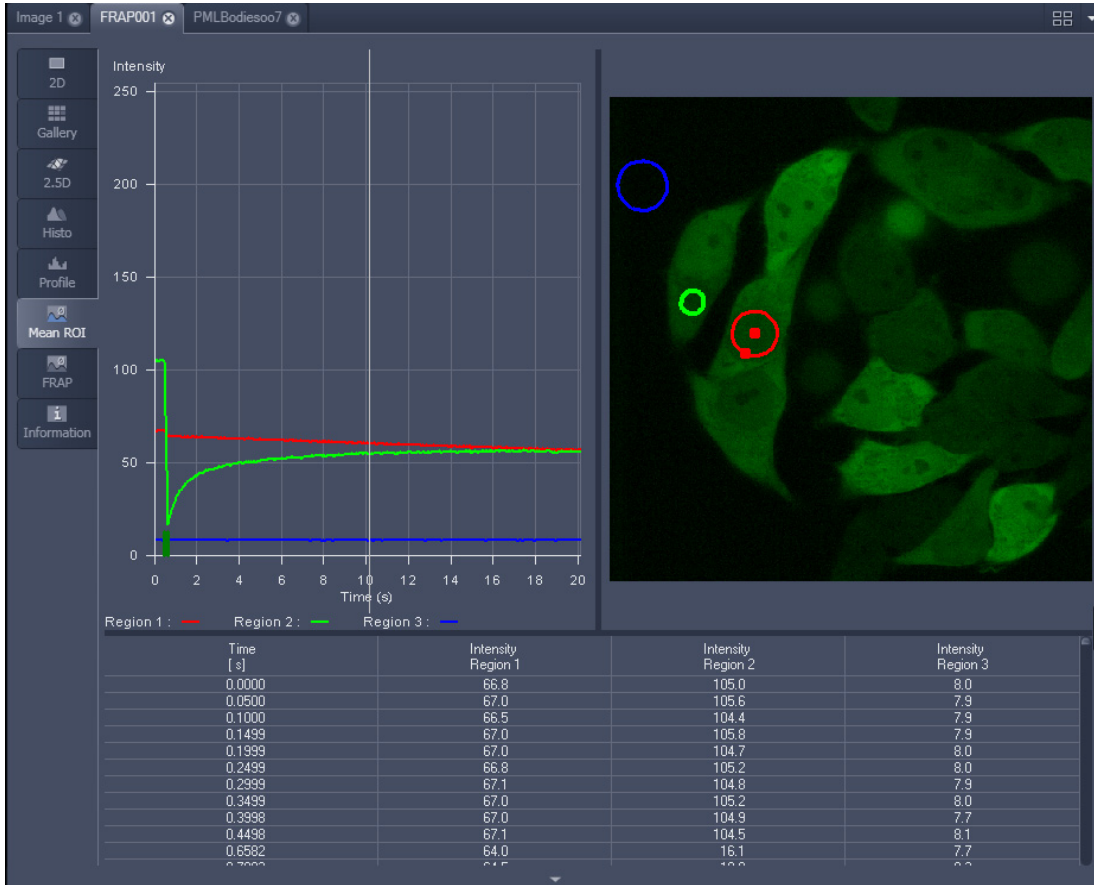


Fig. 250 Image Display window, Mean ROI display for time series in single plane

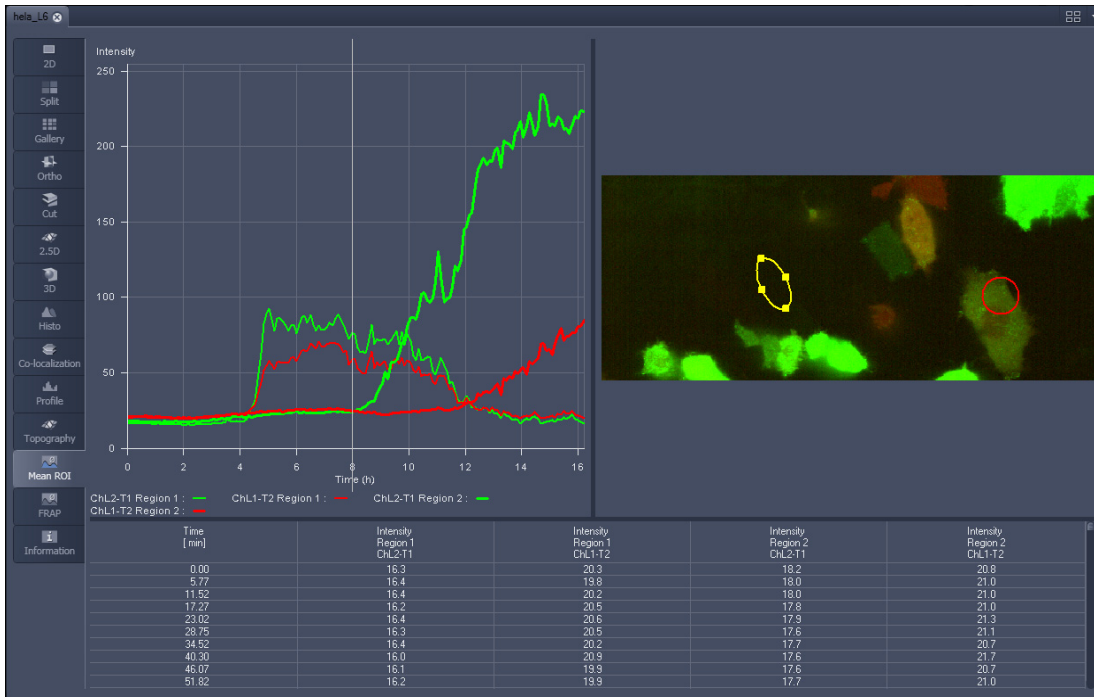





Fig. 251 Image Display window, Mean ROI display for time series of Z-Stack

The **Mean of ROI** view options control block contains the following function elements:

#	Type	X	Y	Width	Height	Lock
1		147	65	51	37	<input type="checkbox"/>
2		239	176	40	40	<input type="checkbox"/>
3		376	121	84	113	<input type="checkbox"/>

ROIs can be managed in the Overlay View Option control block.



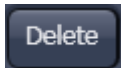
Arrow button: Activation of the mouse button for resizing or movement of the ROI in the **Image Display** window.



Bezier button: Activates the Bezier figure drawing mode. The first click sets the starting point, each additional click adds a further line, a double-click on the starting point closes the figure and ends the procedure.



Circle button: Activates the circle drawing mode. Clicking and holding down the mouse button sets the center point; drag the diameter and release the mouse button to end the procedure.



Recycle bin button: All the ROIs to the image are deleted.



Rectangle and 3D Rectangle button: Activates the rectangle drawing mode. Click and hold down the mouse button, drag the rectangle in any direction, release the mouse button to end the procedure.



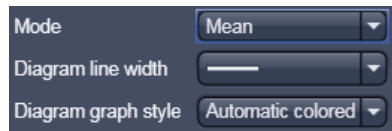
Ellipse and 3D Ellipse button: Activates the ellipse drawing mode. The first click sets the center point, the displayed line permits the determination of the first dimension, the second click sets the first dimension, the second dimension and the rotation direction can then be determined; the third click sets the second dimension and the direction and ends the procedure.



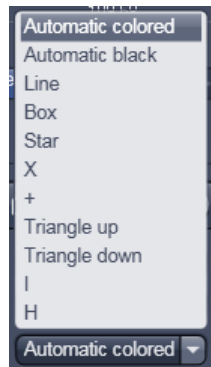
Polyline and 3D Polyline button: Activates polyline drawing mode. The first click sets the starting point, each additional click adds a further line, a double-click on the starting point closes the figure and ends the procedure.



Line button: This button allows you to determine the line thickness of the ROI outline.



Buttons for diagram display options:



Mode pull down: choose between area and mean mode

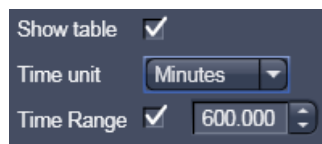
Area: Display of the area of the ROI in the intensity time diagram, depending on the set threshold values. Area measurements of very small areas (< 10 pixels) give only approximate values.

Mean: Display of the mean values of the relevant ROI in the intensity time diagram.

Diagram line width pull down: sets the line width of the curves in the diagram.

Diagram graph style pull down: choose from a set of graph styles

Show Table tick box: The table of intensity values is displayed on the bottom of the Image Display window.



Time unit pull down: choose between seconds, minutes, hours or Automatic

Time Range check box and spin box: reduce the displayed time range to the selected value



In Area Mode: Ch1 / Ch3 / Ch4 pull down: Selection of the channel to be used.



In Area Mode: Threshold low and high slider: The intensity values below /above threshold are not displayed for the **Area** function.

6.14 Kinetic / FRAP View: Additional View Type for Time Series

The **FRAP** function permits interactive analysis of bleaching experiments, including

- Correction of FRAP data for bleaching and background,
- Fitting of FRAP data to a mono exponential or double exponential model for intensity.

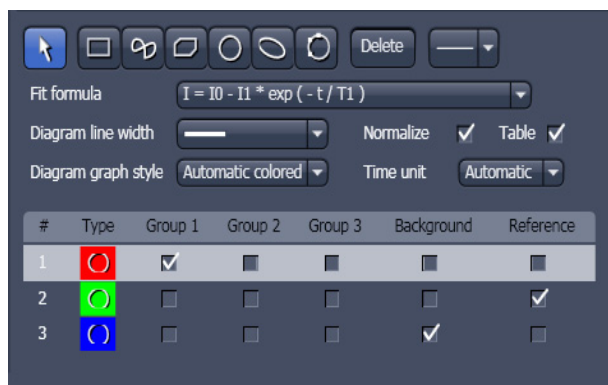


Fig. 252 FRAP View Option control block

The settings of the **Dimensions, Display, Player** and **Overlay** View Options control blocks apply. The additional view-specific **FRAP View Option** control block is shown in Fig. 252.

Any changes done with this View Option control block are effective immediately.

The Image Display in the **FRAP** View shows 4 panels: the intensity-over-time diagram with the fitted curve, the table with the fit parameters, the intensity value data table and the image display (see Fig. 253, Fig. 255 and Fig. 256).

To access the Kinetic / FRAP analysis view type, load or acquire a time series data set and click on the **FRAP** View tab.

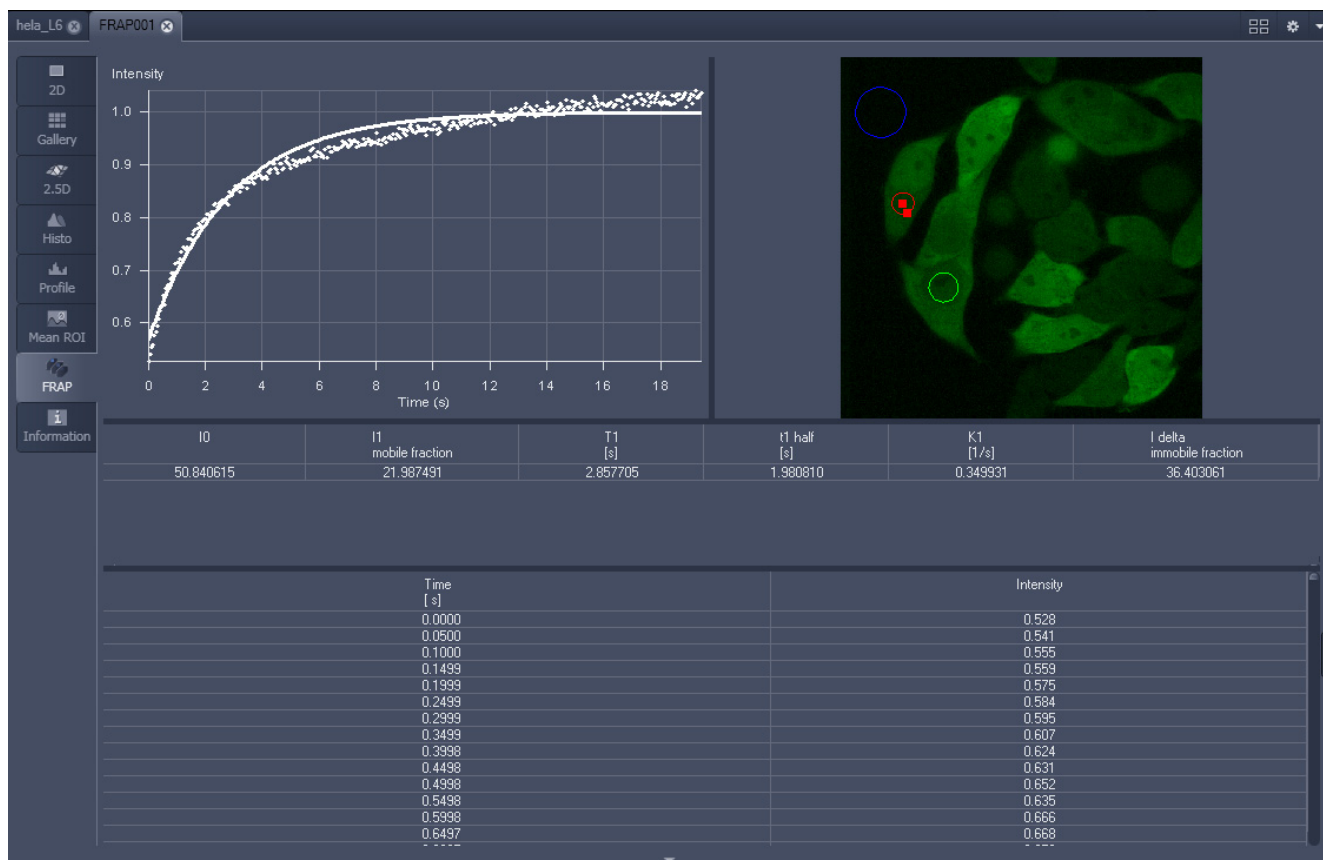


Fig. 253 Image display of a time series in the FRAP View tab

Available tools in the FRAP View:

- | | |
|--|--|
| Channels | Select single channels or all channels for analysis in the general Dimensions view options control box. |
| Kinetic Model / Fit formula | Pull down menu to select the mathematical model (mono or double exponential model) for fitting the data. |
| Analysis Areas / Regions of Interest (ROIs) | The FRAP View Options control block includes drawing tools that work identically to the overlay view options control block. ROIs from both control blocks can be combined. |
| Background Region | Check box in the list of ROIs: Mark the region of interest which represents the mean background intensity to be used for data correction. |
| Reference Region | Check box in the list of ROIs: Choose and mark the ROI which represents the fluorescence intensity of a reference cell that has not been bleached. The mean intensity within that region is used to correct the data at each time point for any bleaching artifact that occurred during the imaging process. |
| Combine Regions
Group 1, 2, 3 | Check boxes in the list of ROIs which allow to choose more than one ROI for analysis and to group them according to the experimental set up. |

Example: FRAP Performed in a Nucleus Expressing GFP Labeled Proteins

Display of the image series in the **Mean ROI** display mode: The drawing tools are used to define the ROI to be analyzed (ROI 1), the background ROI (ROI 2), and the reference ROI (ROI 3) (see Fig. 254). The reference ROI must be a neighboring cell which has been imaged with the same laser intensity over time identical to the cell, which has been bleached to induce FRAP. Make sure the whole cell or cell compartment of interest is imaged and therefore illuminated.

☞ Use the **time** slider in the **Dimensions** view options control block of the general view options group to display the first image after the bleach event. This makes it easy to choose the ROI for analysis. The analysis region should be slightly smaller than the region that has been bleached. The latter is listed in the Mean of ROIs list in the overlay view options control block.

- Define your ROIs for analysis in the **Mean of ROI** View tab.

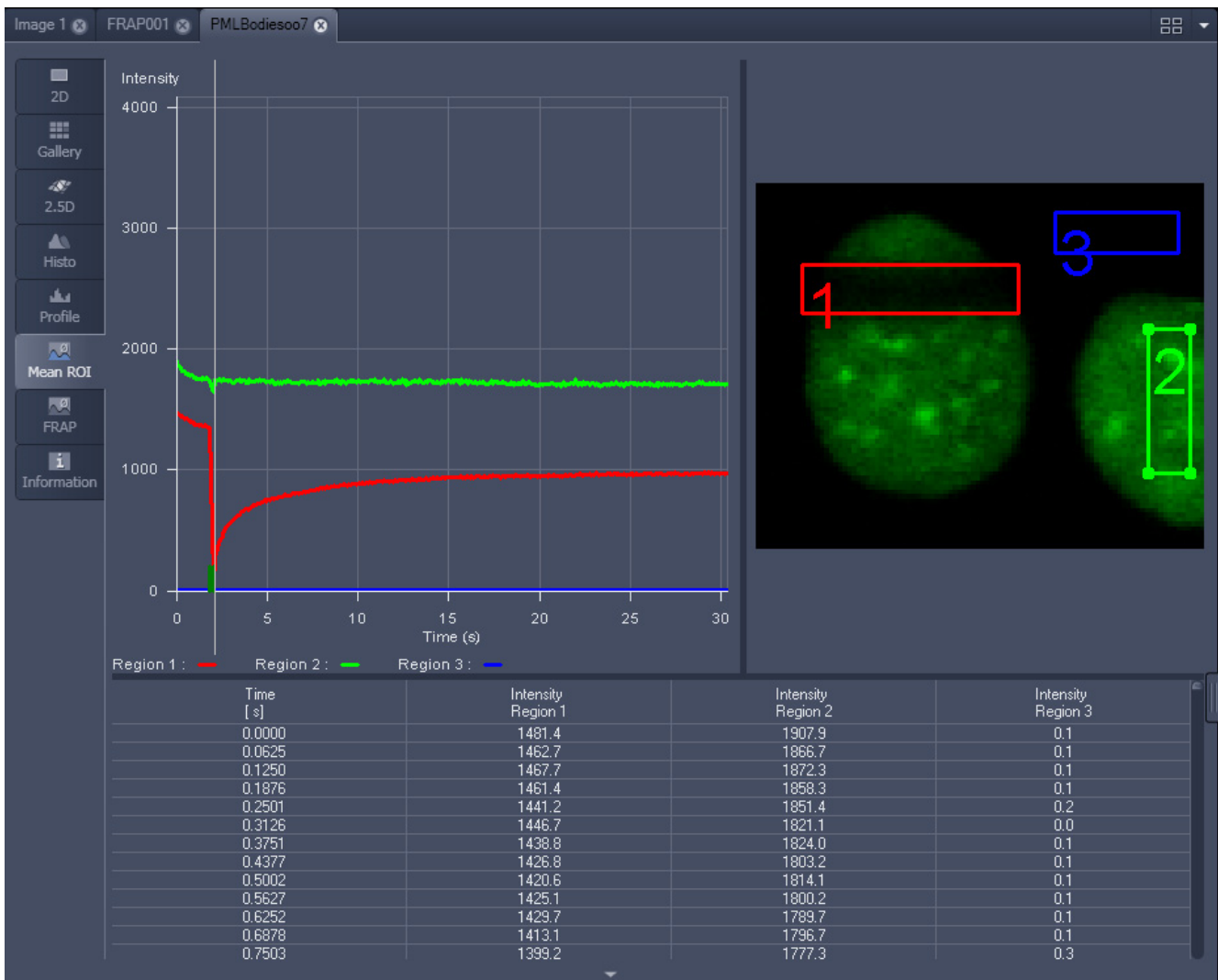


Fig. 254 FRAP data displaying the first bleached image of an images series in the Mean of ROI View Type

- Switch to the **FRAP** View tab.
- Mark the check boxes for background and reference region.
- The intensity values of the ROI to be analyzed will be corrected for background intensity and changes in intensity calculated for the reference region. The correction is done for each time point taking the actual intensity difference in the reference region into account.


The remaining ROI or ROIs are used for analysis when checked active for either group 1, 2 or 3. ROIs assigned to the same group are analyzed added for analysis.


- Chose the **Kinetic Model** in the pull down list.
 - The result of the fit is displayed in the table. The result can be copied to the clipboard (**Copy Results**) or saved as a text file (**Save Results**) (right-mouse click). The following values are calculated and shown:
 - The final signal intensity in the analyzed ROIs following recovery **I0** (of the fitted curve).
 - The amplitude of the fitted curve (which equals the mobile fraction) **I1 mobile fraction**.
 - The fitted parameter **T1** (seconds).
 - The rate constant for the exchange of molecules between the bleached region and the surrounding area **K** (per second).
 - The part of the immobile fraction of the protein **I delta immobile fraction**.


Checking the **Table** tick box opens a further table in the image display area. It shows all intensity values for each channel and ROI analysis group over time. These values are corrected for background intensity and intensity loss of the reference region.


The values can be saved as a text file (**Save Table**) or copied into Excel via right-mouse click (clipboard) (**Copy Table**).

The data can be normalized optionally when marking the check box **Normalize** in the FRAP View Options control block.

 The calculation of the parameters is based on the same ROIs unless other ROIs or moved ROIs are selected again. The Kinetic Display is always available once the analysis has been performed.

 The analysis is not stored with the image.

 Note that this modeling is a very basic approach to your experiment. It offers a first hint on the possible presence of only one or, in case of a bad fit, more than one mobile fractions of the labeled protein within the cell or cell compartment examined. For a more advanced analysis refer to the scientific literature.

 The half time of the recovery can be calculated using the following formula: $t_{\text{half}} = \ln 0.5 \cdot T1$

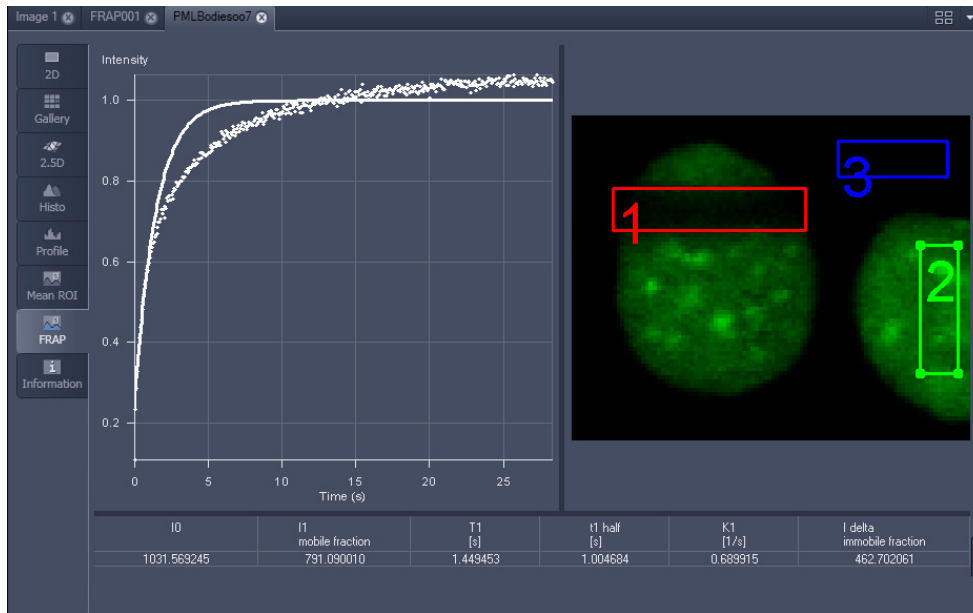


Fig. 255 Image window displaying the analysis of FRAP data using a mono exponential fit

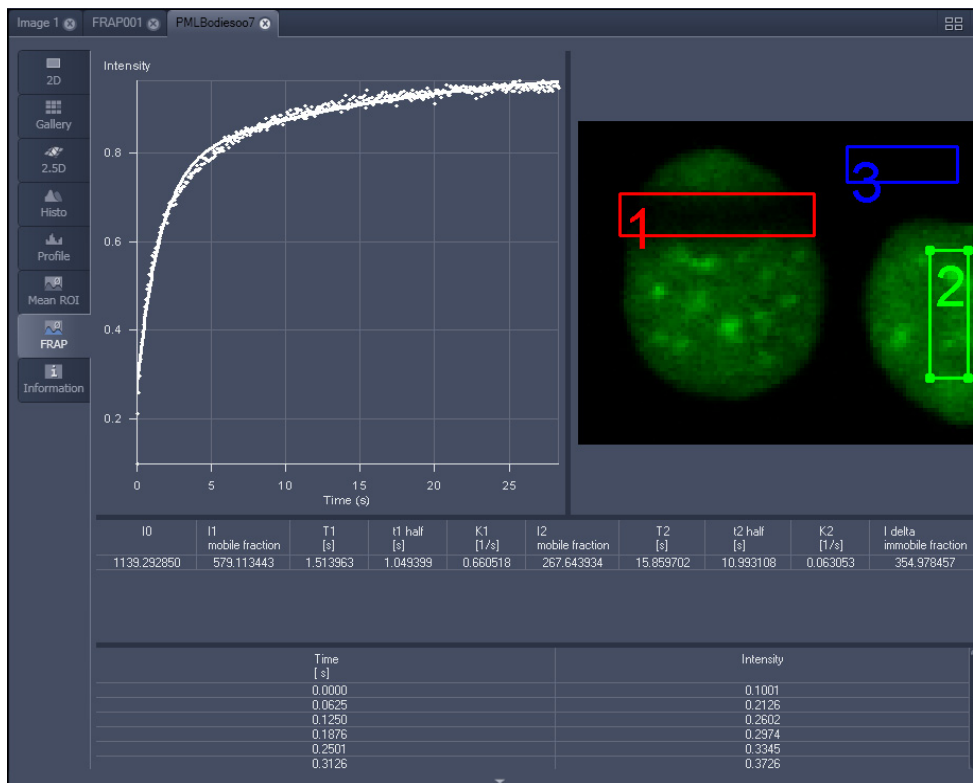



Fig. 256 Image window displaying the analysis of FRAP data using a double exponential fit

If the analysis is done using the double exponential fit the fitted curve displays the mean of the fitted values for the two different mobile fractions. The table shows the following additional parameters:

- The amplitude of the two curves, displayed as one (which corresponds to each part of the mobile fractions **I1** and **I2**).
- The fitted parameters **T1** and **T2** (seconds) for each mobile fraction.
- The rate constant for the exchange of molecules between the bleached region and the surrounding area **K1** and **K2** (per second) for each mobile fraction.

 The raw data of the experiment can be exported for further analysis using the Mean ROI display mode and, within this dialog, the table display of the results.

 Note that this modeling is also a very basic approach to your experiment. It offers a first hint on the possible presence of two mobile fractions of the labeled protein within the cell or cell compartment examined.

Please refer to relevant scientific literature or the website of the EAMNET (<http://www.embl.de/eamnet>) for further information on how to set up and perform FRAP experiments. A schematic curve marking the data points that are calculated performing the Kinetic Analysis is shown in Fig. 257. Please note, that the naming of the data points is not consistent with the information on the website.

A more general introduction to FRAP experiments can be found in the "Methods" brochure "Photomanipulation with Laser Scanning Microscopes" by Carl Zeiss Microimaging GmbH (order no. 45-0060 e/09.06) and the references cited therein.

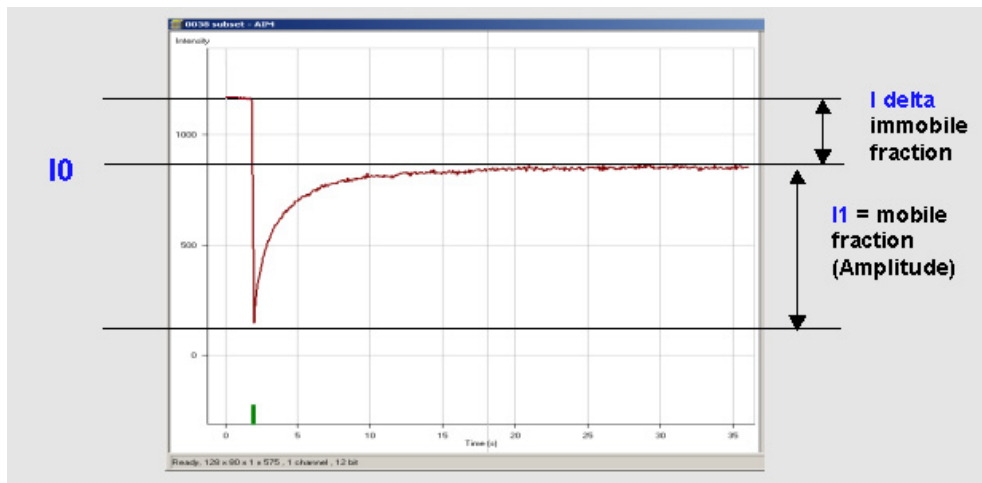


Fig. 257 Schematic FRAP curve with marks at the relevant data points. **I0**, **I1** and **I delta** which are calculated performing the Kinetic Analysis

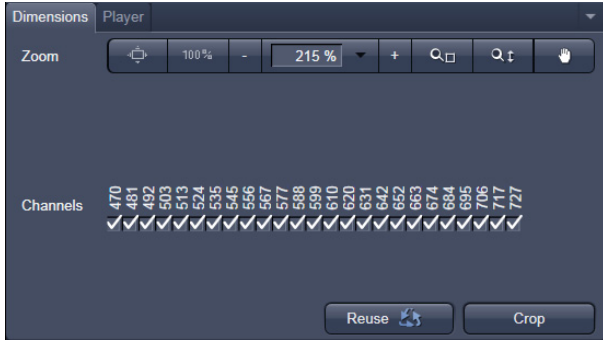


Fig. 258 Lambda Coded - specific Dimensions View Option control block

6.15 Lambda Coded: Additional View Types for Lambda Mode

The **Lambda Coded** View displays a Lambda Stack in a wavelength-coded color view. A color palette is automatically assigned to the individual images which are then displayed in a merge-type display. As a result, each pixel is represented similarly to a view through the oculars without emission filter (see Fig. 259).

The settings of the **Overlay** View Options control block apply as in 2D view. In the **Display** View Options control block, the channel-specific settings of brightness, contrast and gamma don't apply since there are no channels. The **Dimensions** View Options control block is reduced since the wavelength is not a dimension any more when it is color-coded. The modified view-specific **Dimensions View Option** control block is shown in Fig. 258.

Any changes done with this View Option control block are effective immediately.

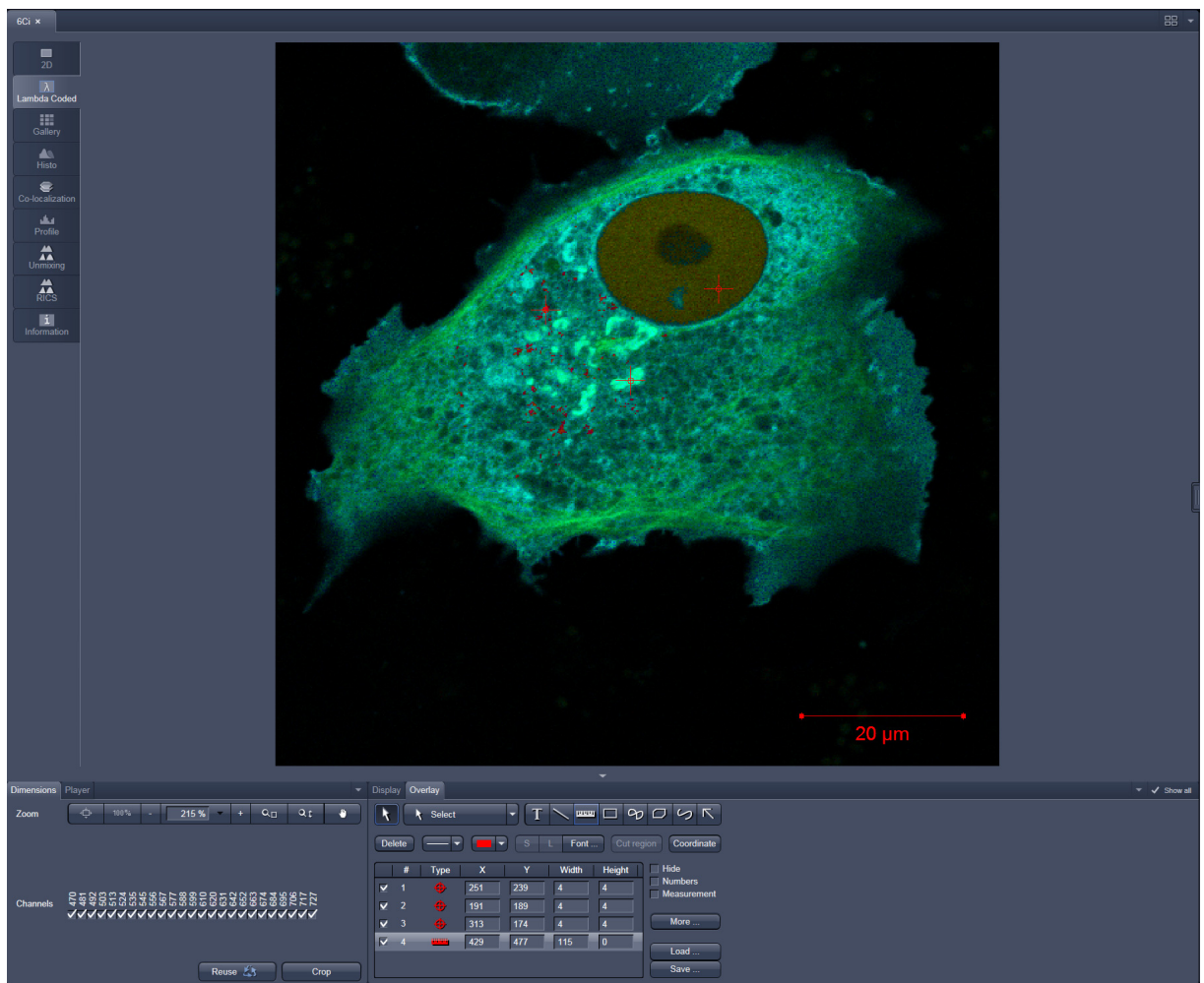


Fig. 259 Dimensions view option control block for Lambda Coded View

6.16 FRET View

In the **FRET** View type (Fig. 260), FRET data sets can be analyzed:

- Data gained performing Acceptor Photobleaching
- Data gained performing Sensitized Emission


The data sets can either be acquired setting up the imaging procedure manually with the system or using the FRETplus Macro.

The **FRET** View will only be present if either a time series with a bleach event or a three channel image is present in the image container.

Any changes done with this View Option control block are effective immediately.

Depending on the type of data the Image Display in the **FRET** View shows 3 panels: the FRET image, the original data and the table with the analyzed data according to the method chosen for analysis.

To access the **FRET** View, load or acquire either a multichannel data set (minimum 3 channels) or a time series with bleach event and click on the **FRET** tab.

 **Tables can always be saved or copied** to the clipboard by right-mouse clicking on the table display!

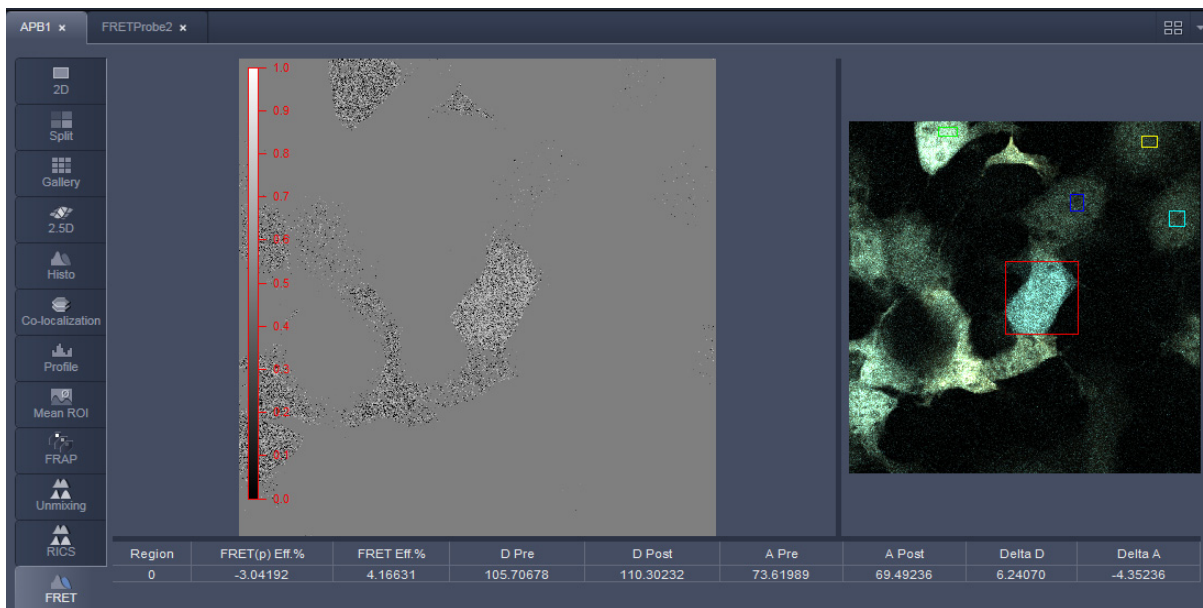
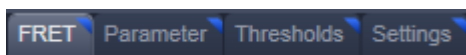


Fig. 260 FRET Display of Time series image having performed Acceptor Photobleaching

Independent of the FRET method, the FRET View Options Control Block offers four tabs:



The available functions within each tab can vary according to the image loaded.

It is assumed that a time series with bleaching represents an experiment with Acceptor Photobleaching and a three channel image represents an experiment performing Sensitized Emission.

6.16.1 Tools in the FRET View Options Control Block for Acceptor Photobleaching

FRET tab (Fig. 261):

Within this tab the overlay regions present in the image (used for bleaching and defined as background or control region) can be defined (The drawing tools correspond to the drawing tools described in section **Overlay**).

As **Method** for FRET Analysis, only **Acceptor Photobleach** is available in the drop down list.

The check boxes **Numbers** and **Measure** refer to the overlay regions and annotate the number of the region and its area to the overlay in the image.

Export allows the resulting FRET image to be saved as a separate image file.

The regions defined can be set as **Object** (Region where FRET should be calculated) or **Background** (from which the threshold for the image analysis can be deduced from).

Regions and the assigned status as Object or Background can be selected or deselected for the individual Analysis using the corresponding check box under **Enabled**.

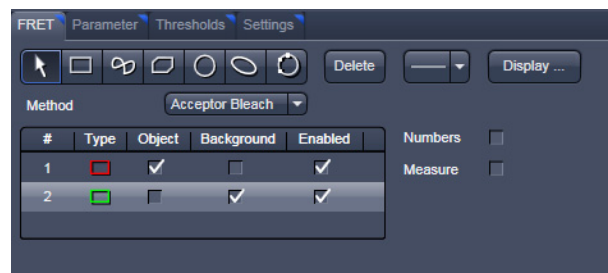


Fig. 261 FRET View Options Control Block, FRET tab

Parameter tab (Fig. 262):

In case the image series for Acceptor Photobleaching has not been acquired with the FRETplus Macro, various Parameters of the image series can be set in this tab.

The image of the Donor and the Acceptor are assigned to the appropriate channel using the drop down menu next to **Donor ch.:** and **Acceptor ch.:**.

The total **Number of images**, the time for the bleaching event (**Bleach after frame**), and the action of **Bleach repeat** is set using the slider next to each action or by editing the field next to the slider.

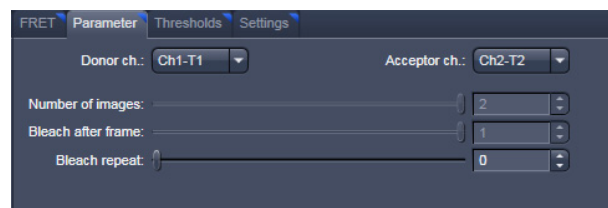


Fig. 262 FRET View Options Control Block, Parameter tab

Thresholds tab (Fig. 263):

The threshold for the image analysis can be set manually using the slider or editing text box next to **Donor**, **Acceptor** or **All**, where **All** moves both sliders to the same value.

Alternatively, the threshold can be set from the image when clicking **From image** provided a background region and an object region have been defined and enabled in the FRET tab.

The values for the thresholds are either displayed as grey value levels (**Raw data**) or **Normalized** to the value 1.

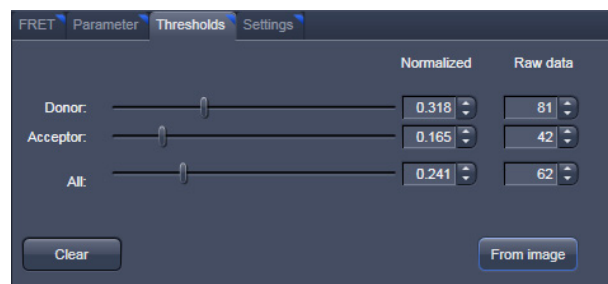


Fig. 263 FRET View Options Control Block, Thresholds tab

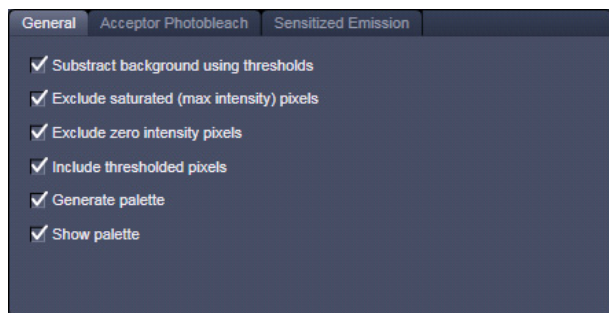


Fig. 264 FRET View Options Control Block, Settings tab, General

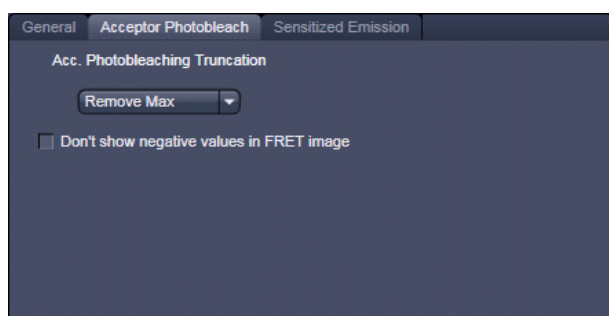


Fig. 265 FRET View Options Control Block, Settings tab, Acceptor Photobleach

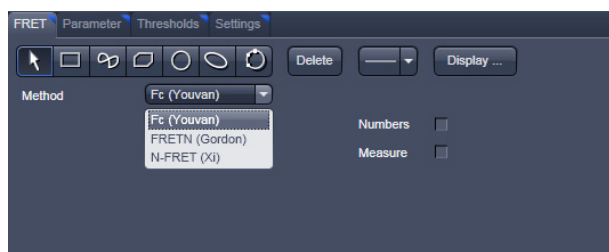


Fig. 266 FRET View Options Control Block, FRET tab

Settings tab (Fig. 264):

This tab provides access to the definition of the parameters used for the image analysis.

The **General** tab applies to both methods, Acceptor Photobleaching and Sensitized Emission.

If checked the listed options will be taken into account for the analysis of FRET.

The **Acceptor Photobleach** tab (Fig. 265) sets additional parameters to analyze the Acceptor Photobleaching experiment such as the choice for **Truncation** (as Remove Max or No Truncation) and the option not to display negative values in the image (**Don't show negative values in the FRET image**).

6.16.2 Tools in the FRET View Options Control Block for Sensitized Emission

FRET tab (Fig. 266):

Within this tab overlay regions can be defined. (The drawing tools correspond to the drawing tools described in section **Overlay**).

The check boxes **Numbers** and **Measure** refer to the overlay regions and annotate the number of the region and its area to the overlay in the image.

Export allows the resulting FRET image to be saved as a separate image file including the table with the results.

The regions defined can be set as **Object** (Region where FRET should be calculated) or **Background** (from which the threshold for the image analysis can be deduced from).

Regions and the assigned status as Object or Background can be selected or deselected for the individual Analysis using the corresponding check box under Enabled.

As Method for FRET Analysis now three different options are available in the drop down list:

- **Fc (Youvan)**,
- **FRETN (Gordon)** and
- **N-FRET (Xi)**.

Fc or Youvan method:

Displays the Fc image with intensities converted from the FRET index calculated for each pixel using the Youvan method. This method assumes that the signal recorded in the FRET channel is the sum of real FRET signal overlaid by donor crosstalk and acceptor signal induced by direct (donor) excitation. There is no correction for donor and acceptor concentration levels and as a result the FRET values tend to be higher for cells that have higher FRET molecular concentrations.

FRETn or Gordon method:

Displays the FRET image with intensities converted from the FRET index calculated for each pixel using the Gordon method. This method calculates a corrected FRET value and divides by concentration values for donor and acceptor. This method attempts to compensate for variances in fluorochrome concentrations by overdoes it. As a result cells with higher molecular concentrations report lower FRET values.

N-FRET or Xi method:

Displays an N-FRET image with intensities converted from the FRET index calculated for each pixel using the Xi method. This method is similar to the Gordon method with the difference that for concentration compensation the square root of donor and acceptor concentration is used. The resulting image is properly corrected for variances in the fluorochrome concentration.

Parameter tab (Fig. 267):

In case the image series for **Sensitized Emission** has not been acquired with the FRETplus Macro, various Parameters of the image series can be set in this tab for the **Last analysis**, the **Acquisition** and the **Image analysis**.

The values for the different Analysis methods to be set (from the images) for the **Donor coefficient** include the FRET signal detected in the donor channel/Donor signal detected in the Donor channel (**Fd/Dd**) and the Acceptor Signal detected in the Donor channel/FRET signal detected in the Donor channel (**Ad/Fd**).

The values for the **Acceptor coefficient** include the FRET signal detected in the Acceptor channel / Acceptor signal detected in the Acceptor channel (**Fa/Aa**), the Donor signal detected in the Acceptor channel / Acceptor signal detected in the Acceptor channel (**Da/Aa**), the Donor signal detected in the Acceptor channel/FRET signal detected in the Acceptor channel (**Da/Fa**), and the Gordon factor **G**.

The image of the Donor the Acceptor and the FRET are assigned to the appropriate channel using the drop down menu next to **Donor ch.:**, **Acceptor ch.:** and **FRET ch.:**

The total **Number of images** is set using the slider or by editing the field next to the slider if necessary.

By clicking the button **Donor** or **Acceptor** the analysis is performed with the new/edited parameters and a new image view is added to the image container (if not already present).

Use the buttons for Donor, Acceptor and FRET in the lower left corner of the image view to alternatively display the three different images.

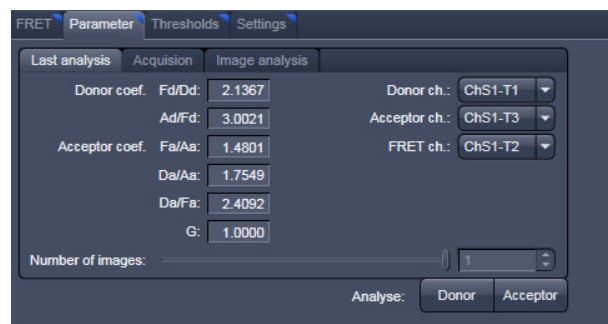


Fig. 267 FRET View Options Control Block, Parameter tab, Last Analysis

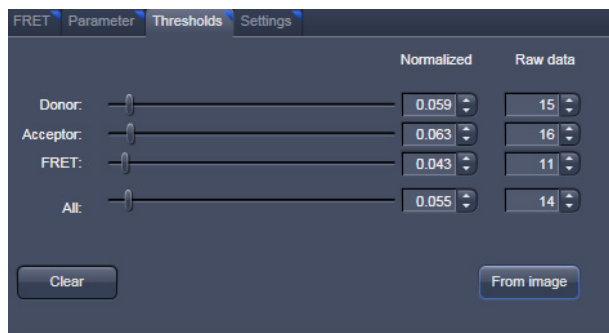


Fig. 268 FRET View Options Control Block, Thresholds tab

Thresholds tab (Fig. 268):

The threshold for the image analysis can be set manually using the slider or editing text box next to **Donor**, **Acceptor**, **FRET** or **All**, where **All** moves all sliders to the same value. Alternatively, the threshold can be set from the image when clicking **From image** provided a background region and an object region have been defined and enabled in the FRET tab. The values for the thresholds are either displayed as grey value levels (**Raw data**) or **Normalized** to the value 1.

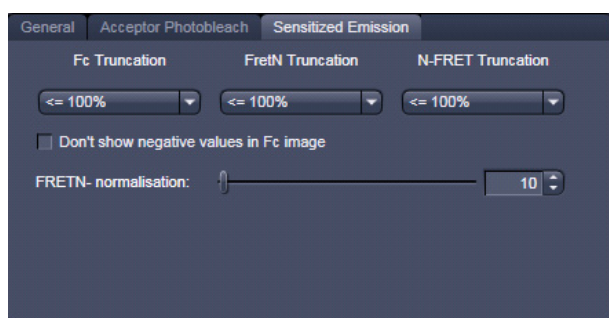


Fig. 269 FRET View Options Control Block, Settings tab, Sensitized Emission

Settings tab (Fig. 264 and Fig. 269):

This tab provides access to the definition of the parameters used for the image analysis.

The tab **General** (Fig. 264) applies to both methods, Acceptor Photobleaching and Sensitized Emission.

If checked the listed options will be taken into account for the analysis of FRET.

The tab **Sensitized Emission** (Fig. 269) sets additional Truncation parameters for each method to analyze the Sensitized Emission experiment such as the choice for **No truncation**, **Remove maximum** or the percentage of truncation to choose between 100, 200 and 300 %.

For the Fc analysis method, the option "**Don't show negative values in the Fc image**" can be selected using the check box. Also included is a slider to set the value for normalization of the results of the FRETn-method.

6.17 Unmixing View

In the **Unmixing View** type, Lambda or channel data sets can be analyzed and spectrally unmixed. In particular it allows to:


- display the spectra corresponding to user-defined ROIs (mean ROI intensity over Lambda),
- use Lambda Stacks and all types of multi-channel images as input (only if the PMTs of the LSM system are calibrated),
- show the intensity values in table form and copy table to clipboard or save as text file,
- generate unmixed multi channel images.

The available tools and the functionality of the four general View Option control blocks **Dimensions**, **Display**, and **Overlay** is the same as in the **Lambda Coded** View (see the previous section on this view type). The two additional view-specific **Unmixing View Option** control blocks are shown in Fig. 270 and Fig. 271.

Any changes done with this View Option control blocks are effective immediately.

The Image Display in the **Unmixing** View shows 3 panels: the intensity-over-lambda diagram with the extraction bands (32-channel-LSM 710 and LSM 780 systems only), the table with the intensities in each ROI over lambda, and the image display (see Fig. 272). The spectra from images which are acquired on an LSM 700 are shown as integrated spectra. This reflects the way, how Lambda stacks are acquired with the LSM 700 (see the respective description in the LSM 700 Manual).

To access the Unmixing analysis view type, load or acquire a Lambda stack data set or a multichannel image and click on the **Unmixing** tab.

 The Unmixing View is available (→ displayed) for all Lambda stacks and for all multi-channel images acquired on hardware with calibrated detectors. This includes all LSM 710, LSM 780, LSM 710 NLO, LSM 780 NLO, LSM 7 MP (if NDD detectors calibrated) and LSM 700 systems.


 Detector calibration is a service task. This calibration allows that reference spectra can be acquired at different detector gain settings than the multi-labeled image acquired for unmixing!



Fig. 270 Unmixing View Option control block

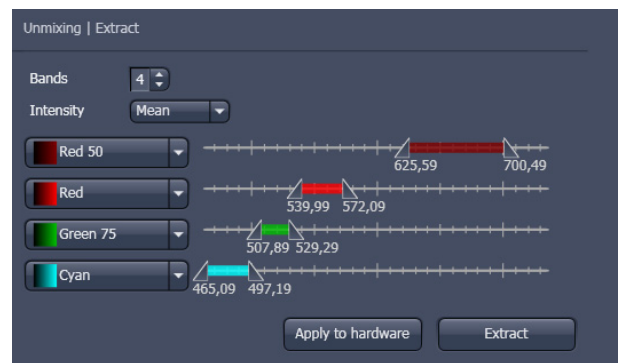


Fig. 271 Unmixing - Extract - View Option control block

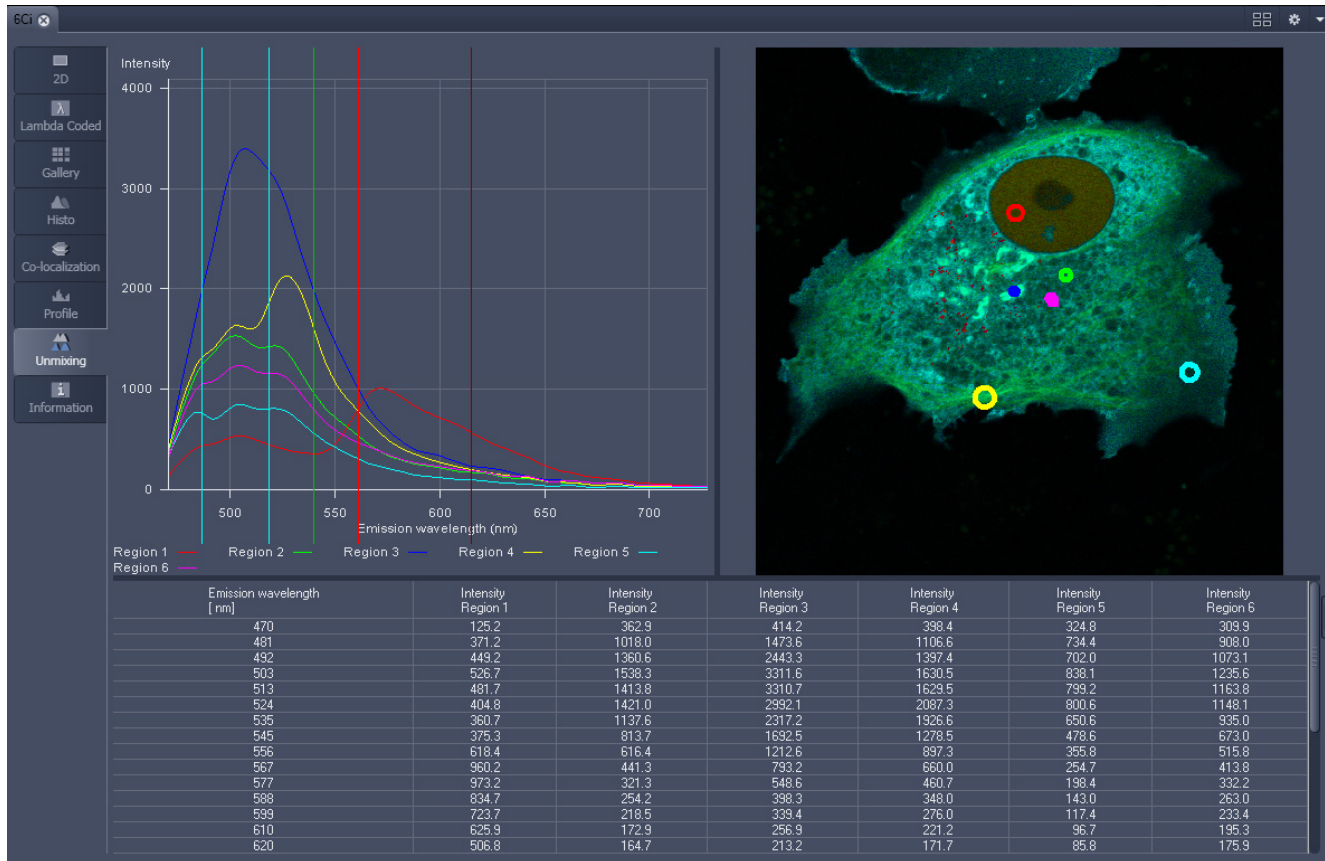


Fig. 272 Unmixing Display of a Lambda stack acquired on an LSM 710 / LSM 780

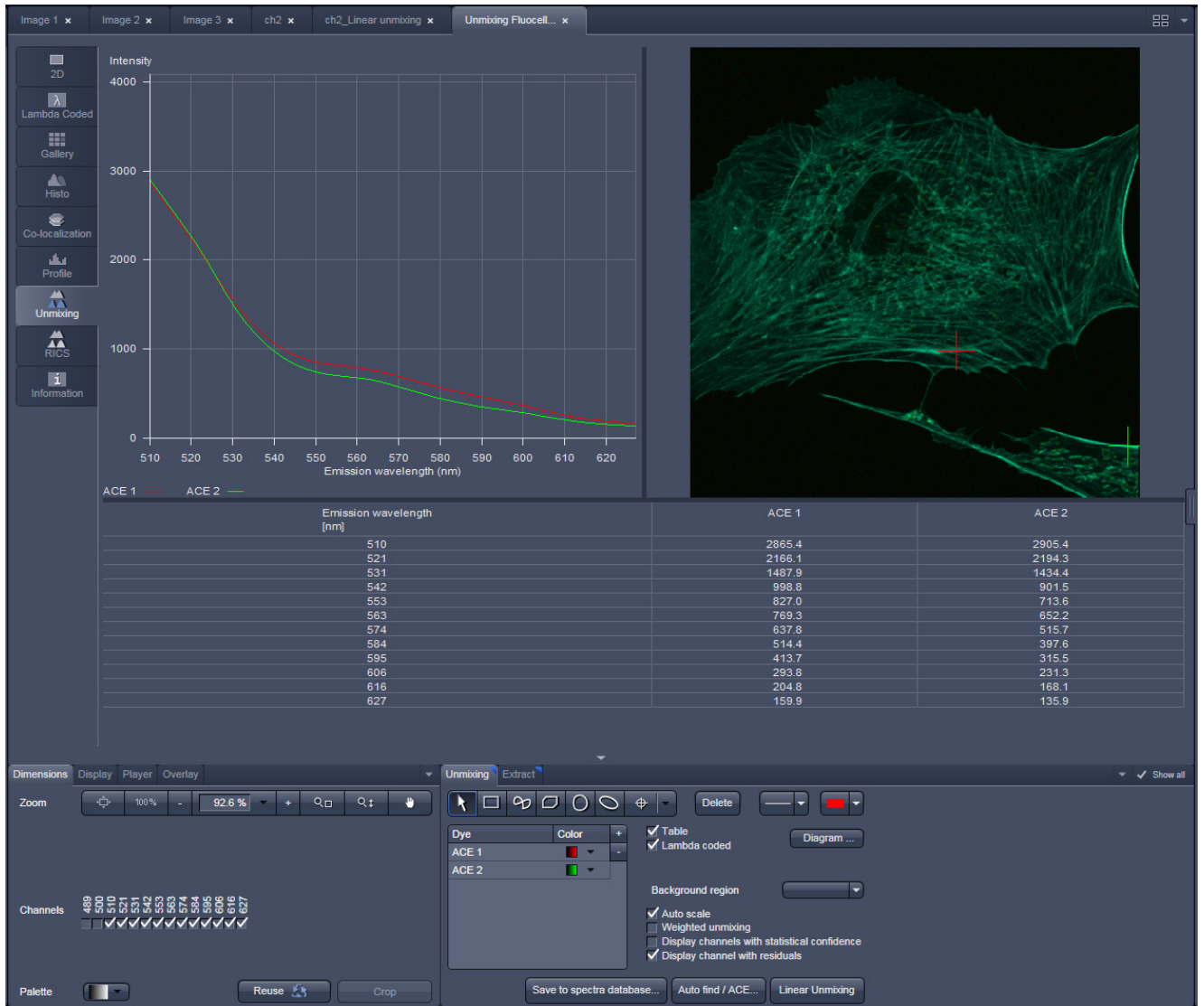


Fig. 273 Unmixing Display of a Lambda stack with a spectral dataset acquired on an LSM 700 with a variable secondary dichroic

Tools in the Unmixing View Options Control Block

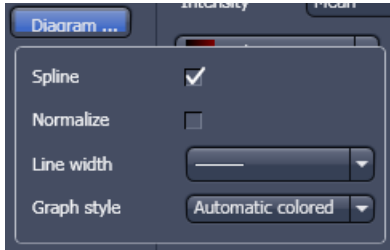
– Tools for display customization and drawing:

Drawing tools

Drawing tools work the same as in the Overlay View Option control block

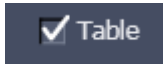


Check box for image display: show the image in greyscale or lambda coded




Dialog for diagram display:

- Spline on/off
- Normalize the graphs of the spectra to 1
- Set the line width of the spectra in the diagram
- Selection of graph style



Show Table button: The table of intensity values over Lambda is displayed in the Image Display window.

 **Tables can always be saved or copied** to the clipboard by right-mouse clicking on the table display!

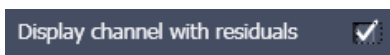
– Tools for unmixing:



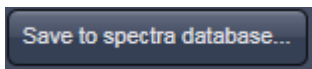
Select ROI for background subtraction



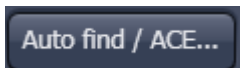
Automatically balances the intensity of unmixed channels to equal levels.



Displays the difference between fit and original data (for the channel of the Lambda stack that shows the greatest deviation) in a separate channel in the unmixed image. (See also section **Linear Unmixing**).



The values of the intensity Lambda diagram are saved to the spectra database in the ZEN\DyeDatabase directory. Make sure to have displayed only data of single dyes in the intensity Lambda diagram when executing this function. (The database interface is shown in Fig. 274).



Auto Find / ACE ("Automatic Component Extraction")

Automatically searches the image for regions with pure signals (Fluorescence originating from one single dye).



Performs the unmixing with the selected spectra. Note: Those channels of the Lambda stack which are de-selected in the dimensions control tab are not included in the unmixing calculation.

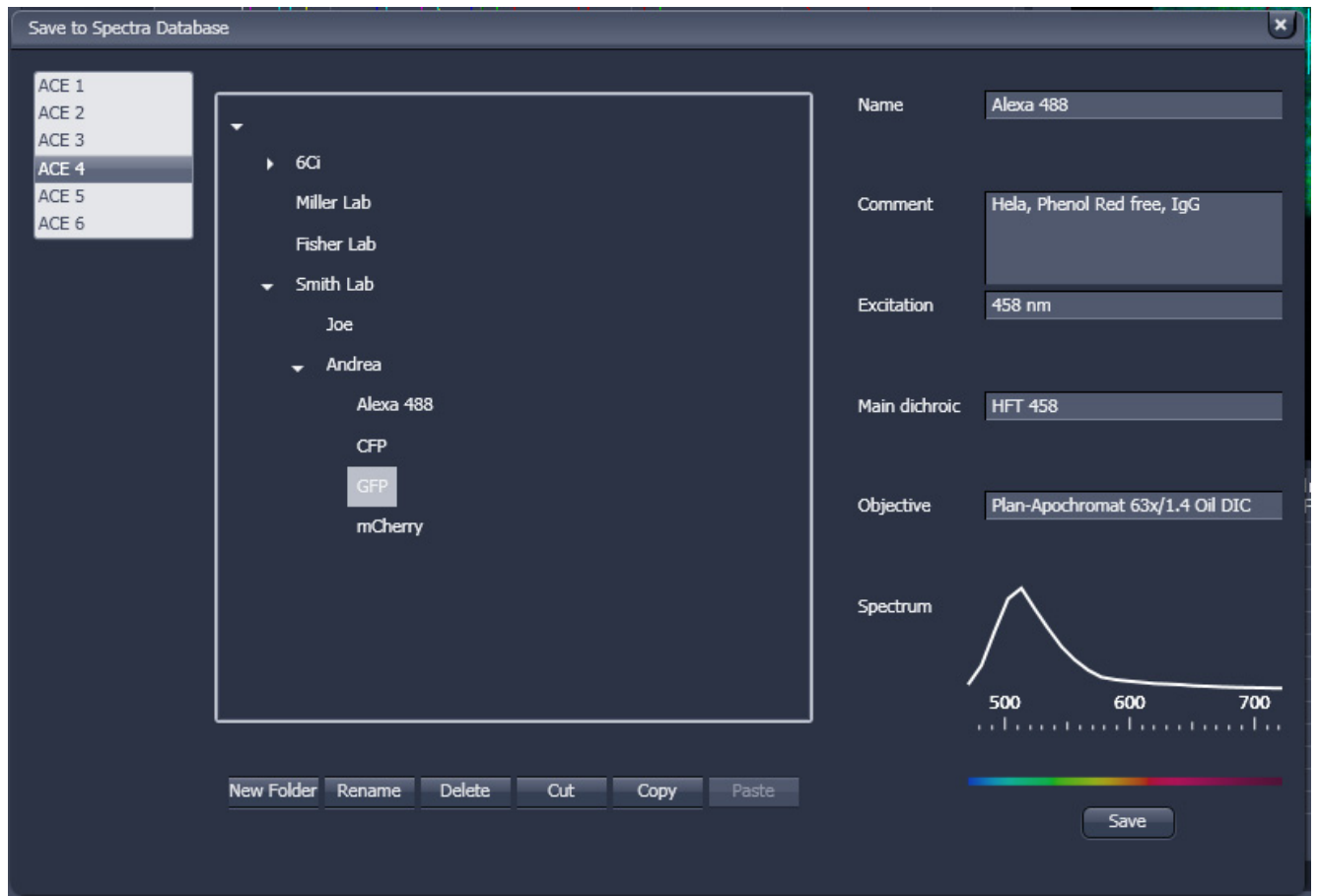


Fig. 274 Save to Spectra Database: database interface with subfolder structure

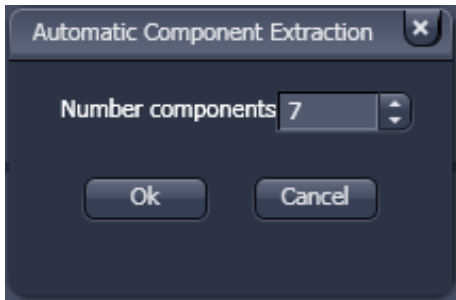


Fig. 275 ACE, number of components selection window

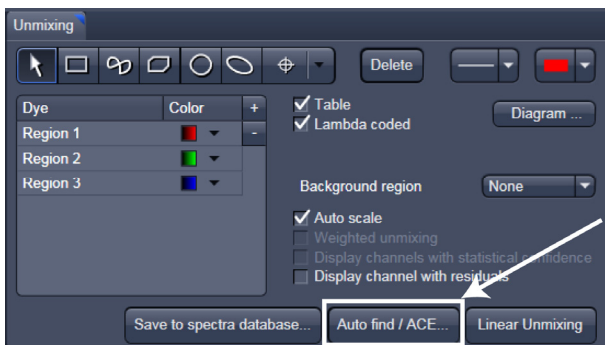


Fig. 276 Automatic Component Extraction function

6.17.1 Automatic Component Extraction

The use of this function permits the automatic search for the individual reference spectra in a Lambda stack.

- Load or acquire a Lambda stack data set.
- Click on the **Unmixing View** tab.

- Click on the **Auto find / ACE...** button in the Unmixing View Option control tab (Fig. 276).
- Select the number of components in the sample and click **Ok** (Fig. 275).
- Review the results in graph.
- When obtained spectra appear reasonable, unmix the data set by clicking the **Linear Unmixing** button (Fig. 276).

- A new and spectrally unmixed multichannel image document is created (as many channels as previously defined components).

Benefit and limitations of the ACE method:

Little to moderate spatial overlap of emission signals is required to obtain good results.

Because it relies on reference spectra extracted from the multi-channel / Lambda stack image itself, ACE could unmix on wrong assumptions and produce poor data.

However, it provides a solution for Emission Fingerprinting in those cases where reference spectra are not accessible via single-labeled controls.

If the resulting data is carefully checked for plausibility and quantification of the results is avoided carried out with the appropriate caution, this often is a helpful tool when working with spectrally overlapping dyes.

Tools in the Unmixing - Extract View Options Control Block:

These tools (Unmixing – Extract) are only available for Lambda stacks on an LSM 710 and LSM 780 system with 34 channel Quasar detector. Hence, they are not available for LSM 700 or LSM 7 LIVE Hardware (tool tab grayed).

Button:



Slider:



Selection of a wavelength range (use the sliders) that will be assigned to a channel. This assignment can be used for scanning (when **Apply to Hardware** is pressed, see below) and /or for extracting a single or multichannel image from the Lambda stack (when **Extract Channels** is pressed). Clicking on the color box in the channel button opens the color selection list and a LUT can be assigned to this channel.



Add (+) or reduce (-) the number of channels displayed and available for assignment. Up to 8 channels labeled after the assigned LUT are available.

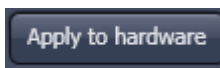


Sum signals from selected detector elements
Mean signals from selected detector elements
Autoscaling of output channels (individually)



channels button

Generates a new image or multicolor images based on the settings made in the channels. Two or more Lambda channels are binned to form the channels 1 ... 8. The generated image is displayed in a new **Image Display** window and is no longer a Lambda stack.



button

Sets the QUASAR detector parameters to match the previously defined spectral ranges / channels. For the used in binning mode as specified in the settings ChS1, ChS2, ChS3 ... ChS8. See **Single Track** and **Multi Track** in **Config Control** for the effect of the action. The **Lambda stack** setting is not affected by this action.

6.18 Raster Scanning Image Correlation Spectroscopy (RICS)

RICS is an image analysis tool that allows retrieving dynamic information from intensity images or image stacks.

RICS analyses the two dimensional spatial correlation in x and y by shifting the image by spatial lag increments and calculating the self similarity of the image.

In this way the correlation image is of the same dimensions as the original intensity image, but it allows the retrieval of diffusion coefficients and numbers of molecules by comparing the correlation function to model diffusion functions.

In order that RICS algorithms work, the pixel size should be at least 5 fold smaller than the $1/e^2$ beam waist of the excitation light.

For example, the beam waist of a C-Apochromat 40x W NA 1.2 objective is 300 nm, so the pixel size should be at least as small as 60 nm. Best results are obtained, if pixel sizes are 10 fold smaller than the beam waist.

Another pre-requisite is the correct scanning speed. This should match the diffusion coefficient of your molecule. As rule of thumbs for molecules diffusing with $D > 100 \mu\text{m}^2/\text{s}$ a speed of 4 $\mu\text{s}/\text{pixel}$ is adequate.

For molecules diffusing with a $D = 10 - 100 \mu\text{m}^2/\text{s}$ a speed approximating 8-32 $\mu\text{s}/\text{pixel}$ dwell time will be appropriate.

Especially too high and slow speeds should be avoided. All molecules with extreme low diffusion coefficients ($D = 0.1 - 10 \mu\text{m}^2/\text{s}$) should be sampled at 32-100 $\mu\text{s}/\text{pixel}$ dwelling time.

Deviations from these settings will result in intensity images not appropriate for RICS analysis.

Last not least molecular concentrations should stay between 1 nm to 1 μm . RICS works best with time series of 20-100 images. More than one image is needed to first improve on the statistics, and second to have the possibility to remove immobile and slowly moving structures.

The RICS procedure can therefore be divided by acquisition of a time series, removing slow moving and immobile structures, computing the correlation and then fitting the data to model functions.

6.18.1 Access to RICS

If you have taken an image or an image series or have opened an old image or image stack, a click on the **RICS** tab of the **View** tab list will make the RICS functionality available.

The right column of the **Image** window will display the Fit table, the middle image the original intensity image and the left one the computed correlation image using a default LUT (look up table) and a scale bar for the correlation (Fig. 277). Below, the result table is displayed.

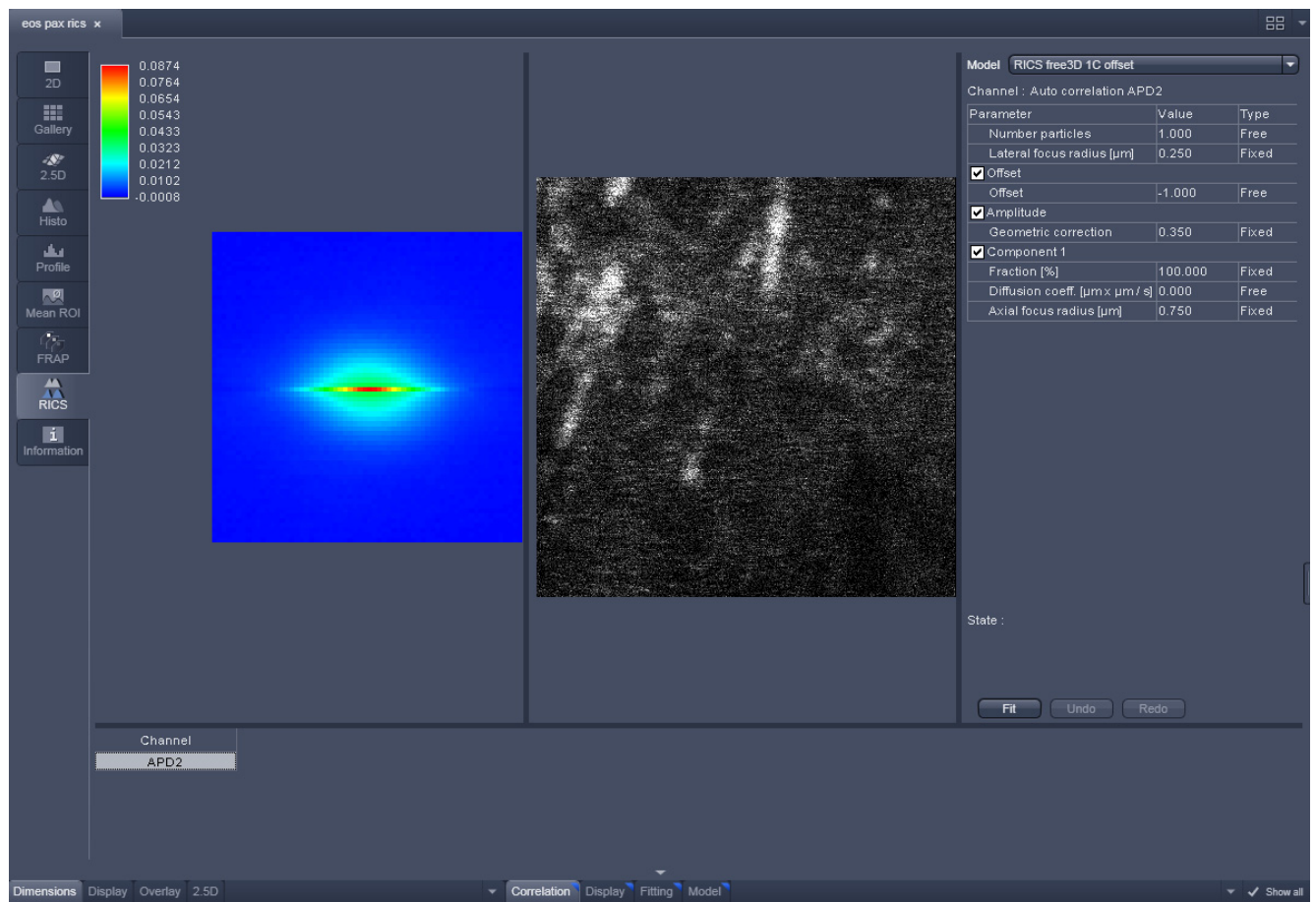


Fig. 277 RICS window with RICS register active

6.18.2 Control of View Functionalities

All required settings and manipulation for the RICS analysis can be called up with the View tabs. They divide into **View** for image manipulation, **RICS** for correlation analysis and **2.5D** for display functionalities. The **View** and **2.5D** options are described at respective sites of the manual dealing with image display. Here RICS functionalities are detailed.

6.18.3 Correlation Functionalities

Activate **Correlation** under the **RICS** view. The Correlation options will be displayed in the View control window (Fig. 278).

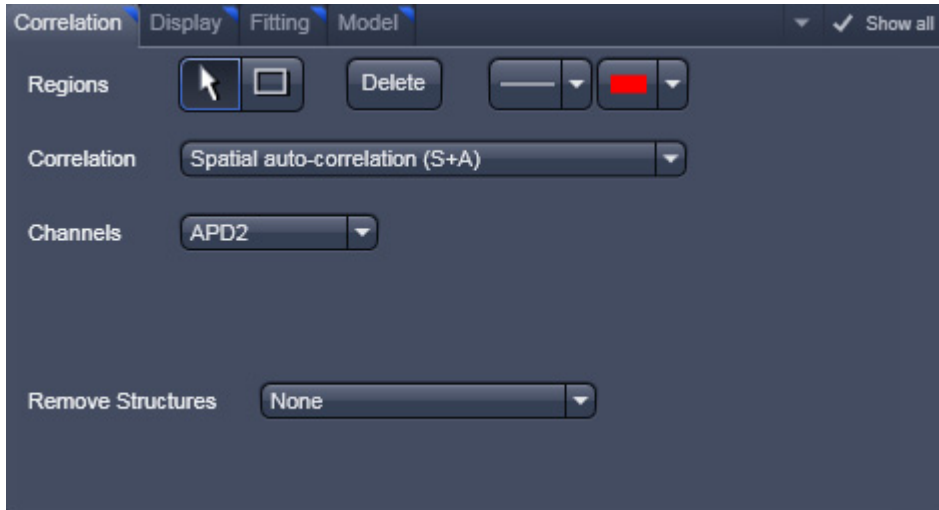


Fig. 278 Correlation control window

Regions allow you to draw regions of interest (ROI) within the intensity image. Activate the **Rectangle** button and draw a region within the intensity image by holding down the left mouse button. Any rectangular shaped region can be drawn. The correlation will be newly computed taken into account now only the ROI.

If the **Arrow** button is active, the ROI can be moved around the image by drag and drop. If the **Arrow** button is deselected, a new ROI will be drawn.

For each ROI a correlation image will be computed (Fig. 279). You can view each correlation by selecting the respective row in the **Result** table at the bottom. It is not possible to view two correlation images at the same time.

If a ROI is selected with the Arrow button active, then pressing the **Delete** button will remove the ROI from the intensity image.

With the **Line** button you can select the line width and with the Color rectangle button the color of a selected ROI via drop down menus.

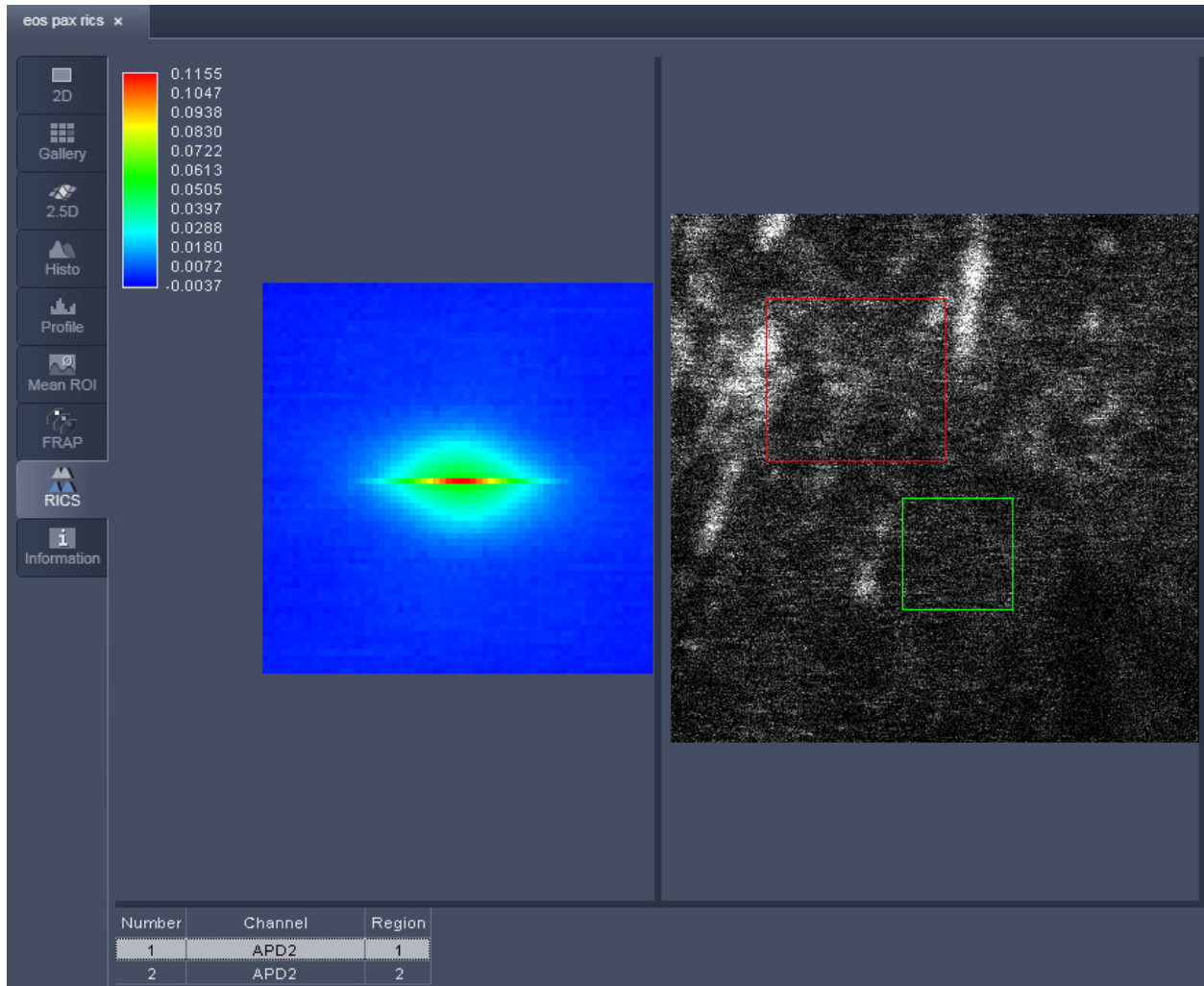


Fig. 279 Image window with two selected regions of interest in the intensity image

Correlation allows you to select the type of correlation analysis you want to perform. For a one channel recording the only option is **Spatial auto-correlation (S+A)**. For a two channel recording you can select from the pull down menu between **Spatial auto-correlation (S+A)** and **Spatial cross-correlation (S+C)** (Fig. 280).

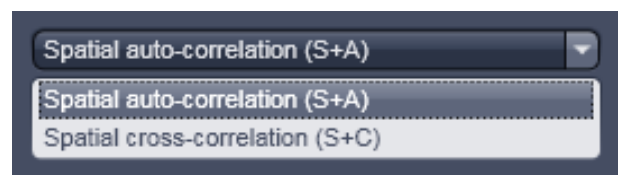


Fig. 280 Correlation pull down menu

Channels allow you to select the channel for which a correlation should be performed. For a one channel record auto-correlation setup, only the active channel is available. For a two channel auto-correlation setup you can select the channel by the pull down menu (Fig. 281). The correlation of the active channel will be computed and displayed. Both channels will be displayed in the **Result** table and the correlation of the selected row will be displayed.

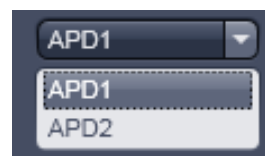


Fig. 281 Channels pull down menu for auto-correlation



Fig. 282 Channels pull down menu for cross-correlation



Fig. 283 Remove structures pull down menu

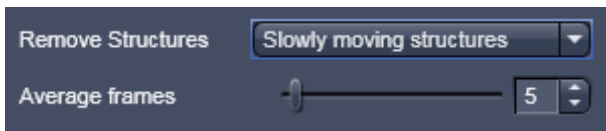


Fig. 284 Averaging frames enter box

For a two channel cross-correlation setup, two drop-down menus will be displayed (Fig. 282). The upper channel will be the one that will be cross-correlated against the lower channel. In addition, two auto-correlations for each channel will be displayed. All correlations will be displayed in the **Result** table and the correlation image of the selected row will be presented. Note, if both channels are identically selected, the cross-correlation all three correlations will be identical auto-correlations for the double selected channel.

Remove structures is needed to remove the contribution of immobile or slowly moving structures from the correlation. You can select what kind of average subtraction you want to perform from the pull down menu (Fig. 283). If **None** is selected, no subtraction will be done.

If **Slowly moving structures** is the choice the **Average frames** enter box will become available (Fig. 284). Choose a moving average frame number that would clean up the correlation from slow moving structures by entering a number in the box, by using the arrows or the slider.

Using 5 frames is a good compromise for nearly all situations. This creates a new stack of $n-m+1$ frames, where n = number of frames from original stack and m = number of moving average frames.

Subtraction of the moving average frames from the original frames starts at $m/2$ and ends at $m/2+(n-m+1)$ frames of the original stack. Thus the first and last frames of the original stacks are not used. To avoid negative pixels by this procedure a scalar is added to each subtracted frame that is computed from all pixels of the moving average that was used for subtraction. The result is a correlation image, that is not any more afflicted by slow moving and immobile structures and from which fast dynamic processes can be calculated (Fig. 285).

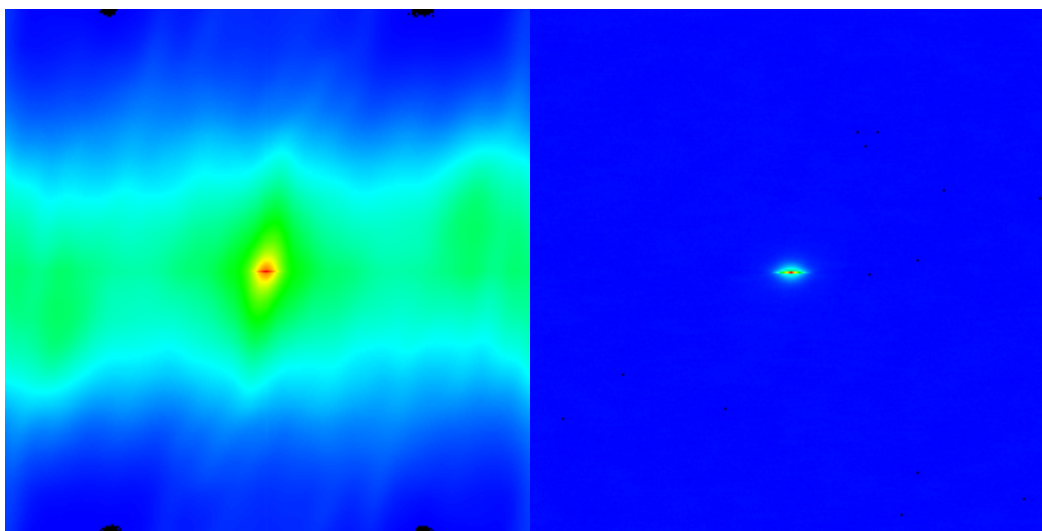


Fig. 285 Correlation image before (left) and after (right) removal of slow moving structures

When **Immobile structures (+Stack)** is selected, the average image from the stack (pixel by pixel) is subtracted from every image and a scalar is added to avoid negative pixels. The scalar is computed from the average of all pixels from all frames of the stack. When **Immobile structures (+Plane)** is selected, the average image from the stack (pixel by pixel) is subtracted from every image and a scalar is added to avoid negative pixels. The scalar is computed from the frame to which it is added. Both procedures are equally valid in most of applications.

6.18.4 Display Functionalities

Activate **Display** under the **RICS** view. The Display options will be displayed in the View control window (Fig. 286).

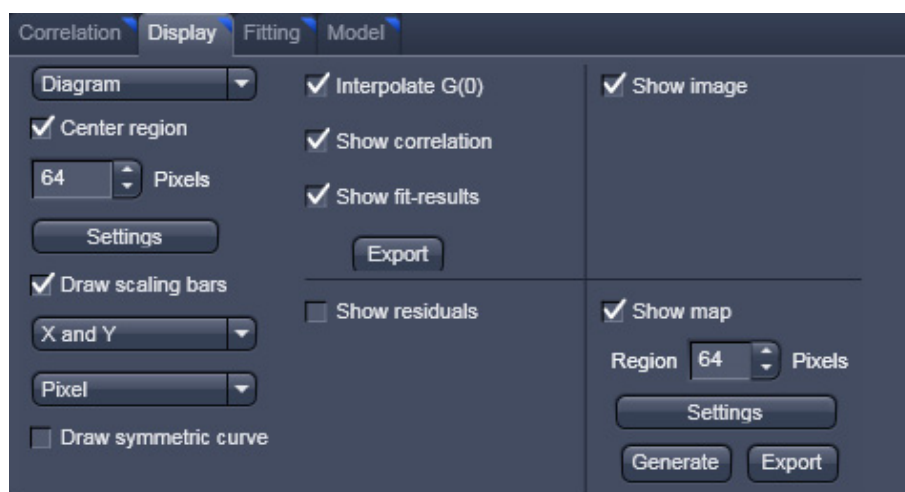


Fig. 286 Display control window

In the **Representation** pull down menu you can choose how the correlation function should be displayed.

Four options are available (Fig. 287):

Diagram will display the horizontal and vertical profiles of the correlation function and the fit / residuals if activated;

Image will display the correlation and the fit / residuals if activated as two dimensional images;

Table will display the coordinates of the horizontal and vertical profiles of the correlation and the fit / residuals if activated that can be copied or saved via a right mouse click from the **Table Export** menu (Fig. 288);

2.5 D will display the correlation function and the fit / residuals if activated as pseudo 3D images (Fig. 289).

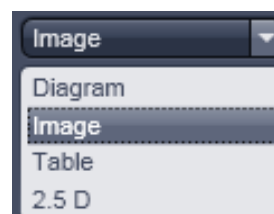


Fig. 287 Representation pull down menu

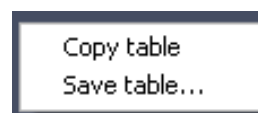


Fig. 288 Table export menu

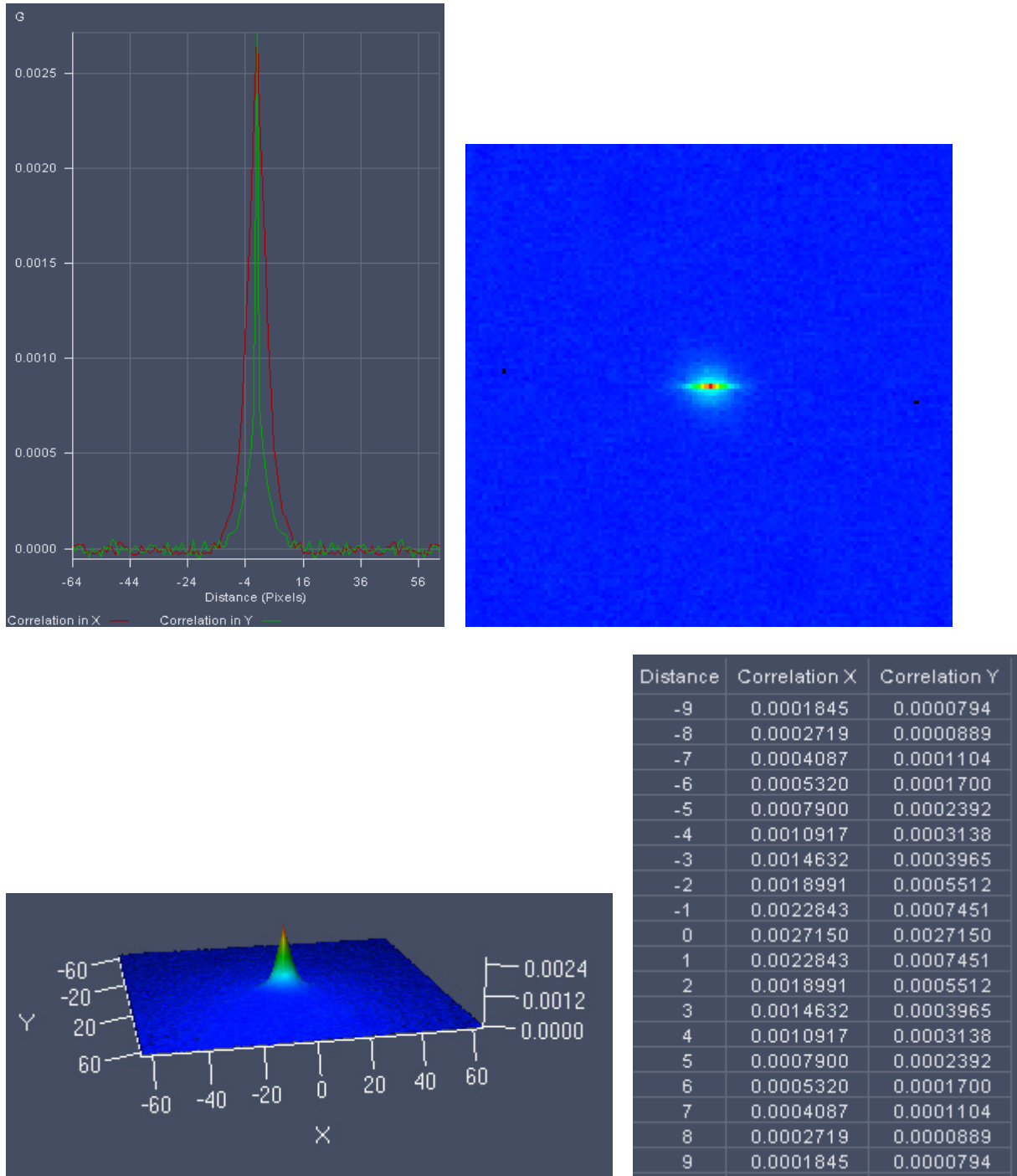


Fig. 289 Correlation displayed clockwise as Diagram, Image, Table and 2.5 D



Note, that for different representations different options will become available.

For the **Diagram**, **Table** and **2.5D display**, the **Pixel** pull down menu becomes available (see Fig. 290). Here you can choose to display distances as integer pixels or metrically in μm .



Fig. 290 Pixel pull down menu

For the Diagram and Table, the **X and Y** pull down menu and the **Draw symmetric curve** check box will be additionally available. In the **X and Y** pull down menu you can choose if you want to display correlations in both (x and y) or only one (x or y) direction (see Fig. 291 and Fig. 292).

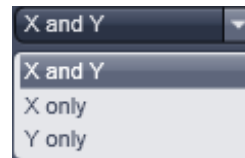


Fig. 291 X and Y pull down menu

If the **Draw symmetric curve** check box is checked (Fig. 292), the correlation will be displayed symmetrically around the zero spatial lag with negative and positive lag values displayed. If the box is unchecked, only the positive lag values will be displayed.



Fig. 292 Draw symmetric curve check box

For the Diagram only the **Settings** popup menu is available (see (Fig. 293)). Here you can assign for the **X and Y Dimensions** individual colors to the **Correlation**, **Fit results** and **Residuals** diagrams via the corresponding color palette drop down menus. You can also define for each dimension the line width by entering a number in the **Line width display boxes** or using the arrows. By checking the left and right **Auto-Scale check boxes**, the diagrams for Correlation & Fit results as well as the diagram for the Residuals, respectively, will be auto scaled to the lowest and highest value. By de-checking you can enter your own minimum and maximum values into the corresponding **Min.** and **Max. display boxes** by typing or by using the arrows. All values between the minimum and maximum will be scaled accordingly. Values lying outside will not be displayed.

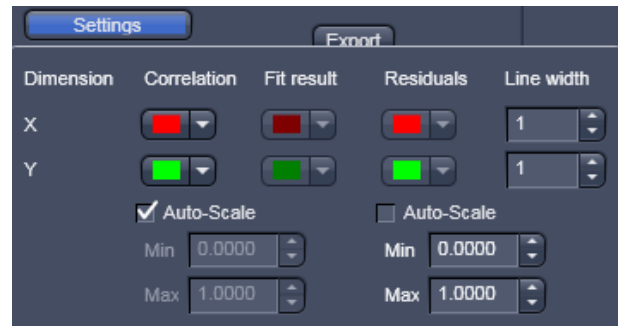


Fig. 293 Settings popup menu

If the **Center region** box is checked the correlation will be centered on the pixel numbers that can be put into the displayed **Pixels** input box. This allows you to display only the relevant part of the correlation and avoid areas of no content.

If the **Draw scaling bar** box is checked, a Scaling will appear for any correlation diagram and deviated diagram (Fit, Residuals, Map). For the intensity image, no scaling bar is available.

If the **Use image palette** box is checked, the look up table (LUT) selected for the intensity image will be taken for the correlation diagram and Maps; the LUT will not apply for Fit and Residuals. If the **Interpolate G(0)** box is checked the zero spatial correlation value will be interpolated.

Checking and unchecking the **Show fit-results** box will toggle between the correlation and fit images. Note, if this box is activated, the **Interpolate G(0)** box will disappear. Pressing the export button below the **Show fit-results** box will export the correlation image or fit image, whatever is active as an image in .lsm format.

If **Table**, **Image** or **Diagram** was selected from the **Representation** pull down menu, the 2D image will be exported. If 2.5 D was selected, a pseudo 3D image will be stored. If the Show residuals box is checked, the Residuals will be displayed in a format as selected in the **Representation** pull down menu (Fig. 287). By activating this box the **Hide G(0)** error check box becomes available as well. Check the box in order to omit the zero spatial correlation value to be included in the fit.

Pressing the export button below the **Hide G(0)** box will export the residuals image. If **Table**, **Image** or **Diagram** was selected from the **Representation** pull down menu, the 2D image will be exported. If 2.5 D was selected, a pseudo 3D image will be stored. Activating / Deactivation the **Show image** check box will display or remove the intensity image from the **Center image** window.

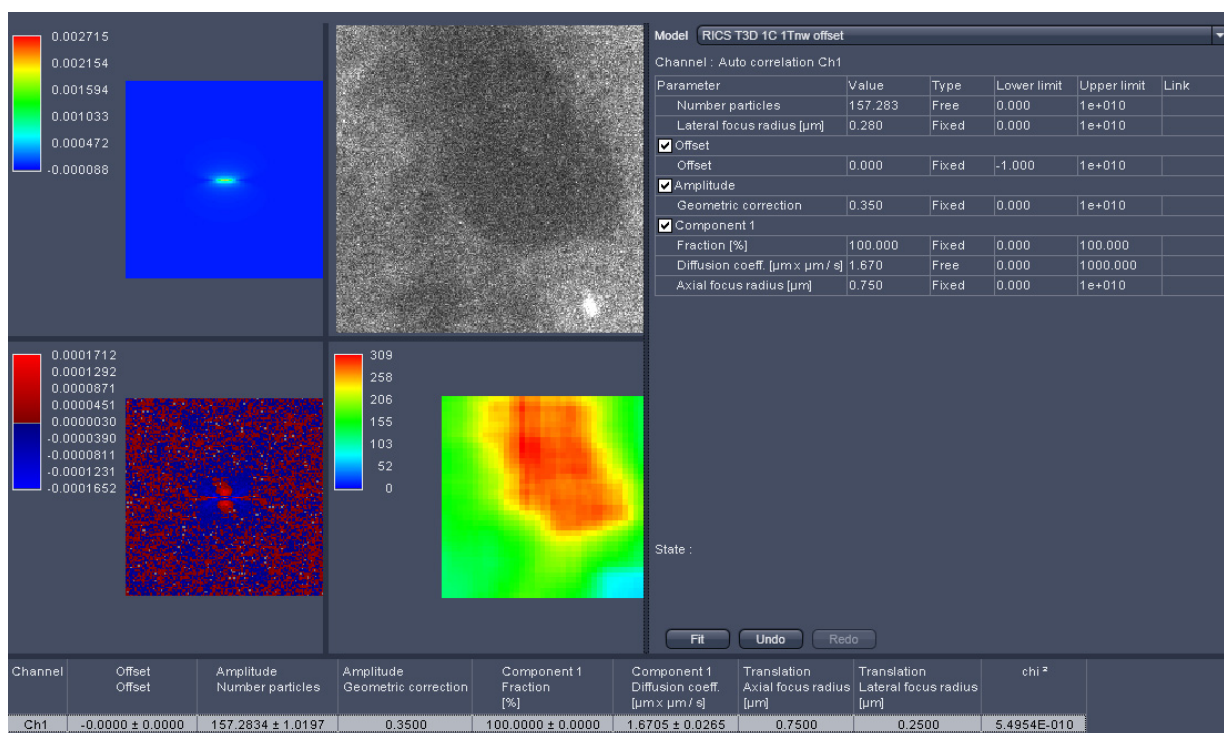


Fig. 294 Center Image window displaying Fit image, Intensity image, Fit table, Residuals Image, Map and Result table (from top left to bottom right)

Note that the **Draw scaling bar**, **Use image palette** and **Hide G(0)** check boxes will only be available in the RICS **Show all** mode. To activate the **Show all** mode activate the RICS **Show all** button on the **View Control** bar.

If the **Show map** box is checked, a map, if being created before, will be displayed and the map options will be visible. In the **Region in Pixels** input box you determine the size of the region in an m x m format to be used for mapping the intensity image. This size should naturally be smaller than the image size, but it is recommended not to fall below 64 x 64 pixels to obtain enough signal-to-noise ratio (SNR).

If you press the **Settings** button, the settings menu will pop up (Fig. 295).

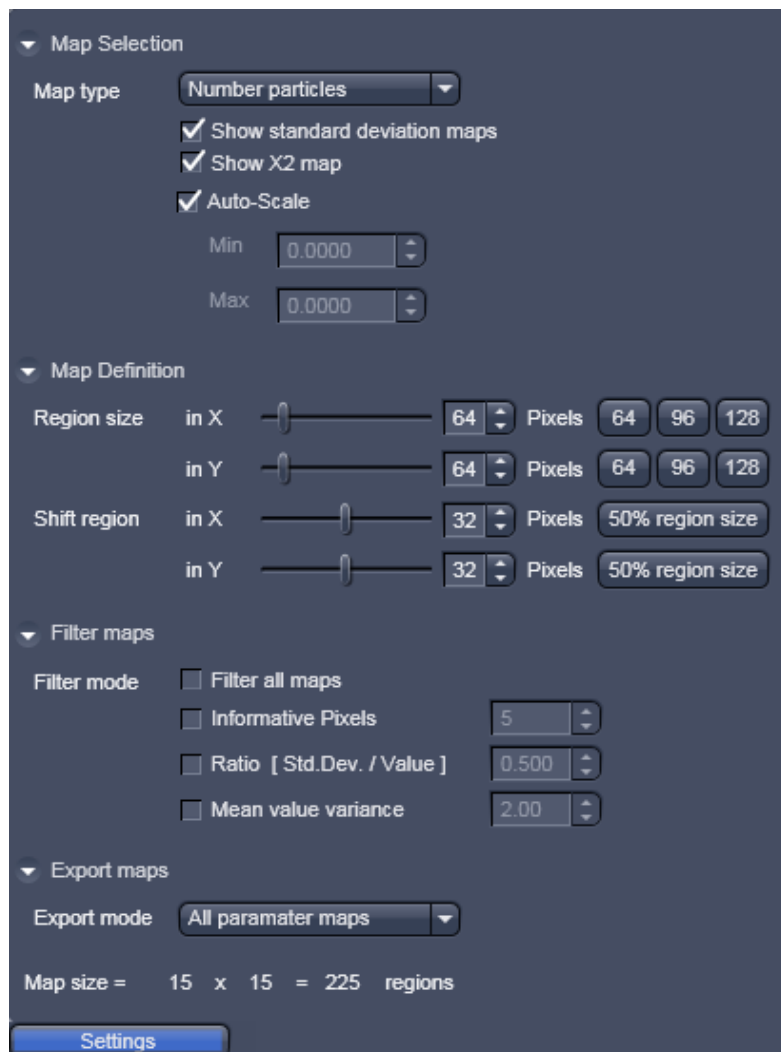


Fig. 295 The Map settings menu

In **Map Selection** you can determine the map type with the **Map type** pull down menu (Fig. 296). You can choose between the **Number particles** and the **Diffusion coeff. ($\mu\text{m} \times \mu\text{m} / \text{s}$)** parameter maps, that will display the relative molecule numbers –please note that if average subtraction is performed the information on absolute numbers is lost - and diffusion coefficients of the mapped areas.

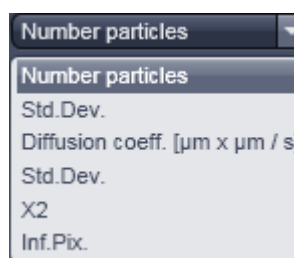


Fig. 296 Map type pull down menu

You can also display the informative pixels by choosing **Inf.Pix**. This will display a map that indicates, how many pixels contributed meaningfully to the correlation before dropping to zero.

If the **Auto Scale** check box is activated, the maps are scaled automatically between the highest and lowest value. If unchecked you can enter in the **Min** and **Max input boxes** own minimum and maximum values. All values lying between will be accordingly scaled. Note that all values lying outside the

minimum and maximum will be displayed as black in the maps. This option is helpful in eliminating extreme outliers.

In the **Show all** mode you have further the option to display the **Std.Dev.** (standard deviation) maps of both parameter maps as well as the X^2 (Chi square) map by checking the **Show standard deviation maps** and **Show X2 map** boxes.

In **Map definition** you can define the region size in an m x n format. Please note, if you don't choose a size as an integer part of the intensity image, some rest areas to the right and bottom of the image will not be taken into account. Region sizes can be put into the **Region sizes in X / Y in Pixels** input boxes by using the slider, arrows or typing. Default values in an m x m format can be obtained by pressing the **64**, **96** or **128** buttons. The step size with which the region will be shifted from data point to data point can be put in the **Shift region in X / Y in Pixels** input boxes by using the slider, arrows or typing. The default value of a shift size half the region size can be obtained by pressing the **50% region size** button.

In **Filter maps** different **Filter modes** can be selected to sort out outlier values. Extreme outliers will affect the scaling of the map so that interesting values can be hidden. By checking the **Filter all maps** box, chosen filters will be applied for all maps. If not selected only the map chosen in the **Map type** pull down menu will be filtered. You can choose between Informative Pixels, ratio and mean / variance filter by checking the respective **Informative Pixels**, **Ratio (Std.Dev./Value)** and **Mean value variance** boxes. Thresholds can be set in each case via the input boxes by typing or using the arrows. Note that filters can be combined.

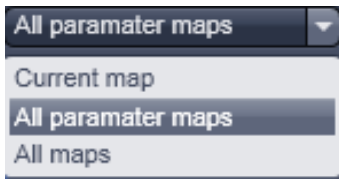


Fig. 297 Export mode pull down menu

In Export maps one can select which maps should be exported as an .lsm image by selecting between the **Current map**, that is only the map selected in the Map-type pull down menu, **All parameter maps**, that are the **Number particles** and **Diffusion coeffic. ($\mu\text{m} \times \mu\text{m} / \text{s}$)** maps, and **All maps**, that are the parameter maps, **Std.Dev.** maps and X^2 maps (Fig. 297).

The map size in terms of region numbers is displayed in the info area of the **Settings** menu.

By pressing **Generate** a map is created with region and shift sizes as determined in the settings. During creation of the new map, an old map will be overwritten. The progress in calculation is displayed in the intensity image by an overlay region and the black map is filled with white regions (Fig. 298).

The **Generate** button will only be active, if the correlation was fit to a model beforehand to ensure the correct one was selected.

Only at the end of the map, the scaling is calculated and the map displayed in the chosen palette. By pointing the pointer to a region in the map, the corresponding site from which this data point was derived will be displayed in the intensity image by the overlay region. By pressing **Export** maps will be saved according to the settings in an .lsm format or the type you choose in the Windows Explorer popup menu.

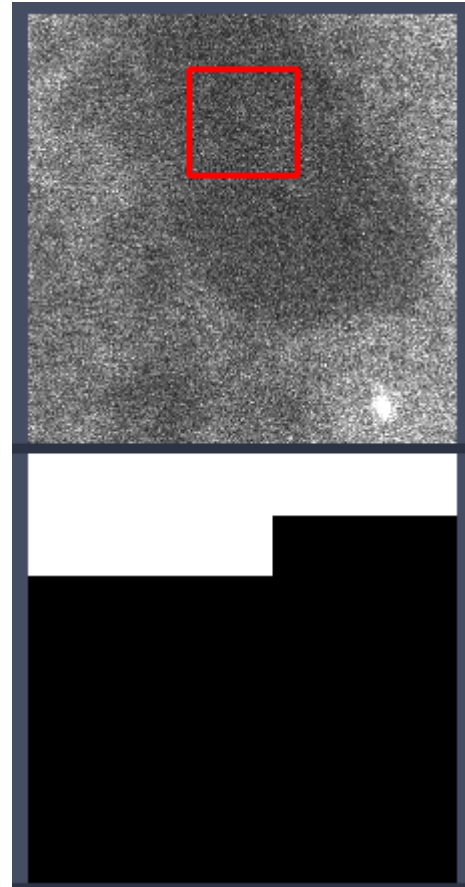


Fig. 298 Progress indicator during creating a map in the intensity (upper panel) and map (lower panel) images

6.18.5 Fitting Functionalities

Activate **Fitting** under the **RICS** view. The Fit options will be displayed in the View control window (Fig. 299).

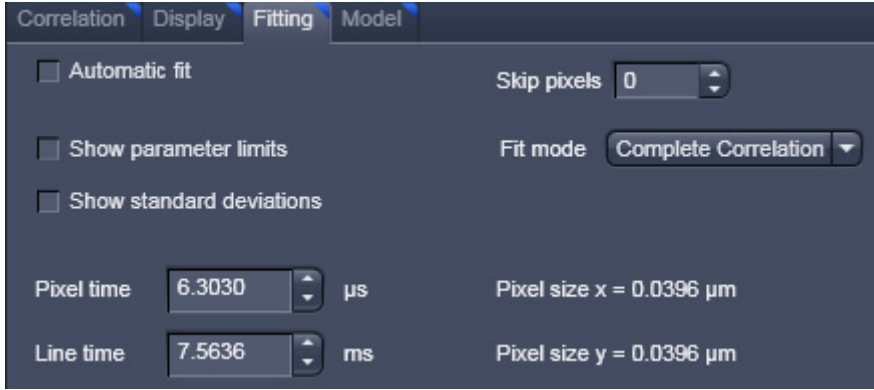


Fig. 299 Fit control window

If the **Automatic fit** check box is selected, a fit will performed automatically, whenever the correlation input intensity image is changed. For example, if a region of interest is drawn or moved within an intensity image, the fit will automatically be performed according to the default or loaded model. If the check box is deselected, a fit will only be performed when pressing the **Fit** button in the **Fit** table (Fig. 300).



Fig. 300 Fit table

You can select a model from the **Model** pull down menu in the **Fit** table. Every stored model will be listed (Fig. 301). Below the **Model** pull down menu the active channel is displayed in the **Channel** display area. The table below lists the terms and parameters of the selected model in the **Parameter** column, its current value in the **Value** column, the type of the parameter in **Type** column that can be set as **Free** (freely floating with initial guess), **Fixed** (no fit) and **Start** (freely floating with start value) from the **Type** pull down menu between (Fig. 302), the lower and upper limits assigned by typing in the desired number to the parameter in the **Lower limit** and **Upper limit** columns and the type of global linkage in the **Link** column, which presently is not activated. Terms in the parameter columns can be activated or deactivated by ticking or un-ticking the respective check boxes.



Fig. 301 The model pull down menu of the Fit table

In the **State** display area any abnormal settings will be displayed. For example, if Number particles and Geometric factor are both set to free, the system will comment that one has to be fixed (Fig. 303).



Fig. 302 Type pull down menu

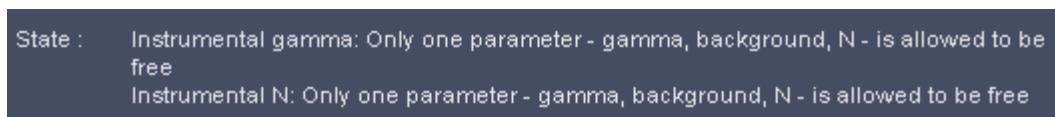


Fig. 303 The State display area with message

To perform a fit press the **Fit** button. The active correlation function will then be fitted according to the settings in the **Fit** table. Pressing the **Undo** button will cancel the commands in the reverse order of their placement. The **Redo** button will become active once the **Undo** button has been pressed once. It allows recalling cancelled commands in the order of their cancellation.

Fit results and statistics will be listed in the **Result** table (Fig. 304). It lists the channel and all parameters (with or without standard deviation according to the settings) that are present in the **Fit** table as well as the χ^2 (chi²) value of the fit.

Channel	Offset Offset	Amplitude Number particles	Amplitude Geometric correction	Component 1 Fraction [%]	Component 1 Diffusion coeff. [µm x µm / s]	Translation Axial focus radius [µm]	Translation Lateral focus radius [µm]	chi ²
Ch1	-0.0000 ± 0.0000	157.2834 ± 1.0197	0.3500	100.0000 ± 0.0000	1.6705 ± 0.0265	0.7500	0.2500	5.4954E-010

Fig. 304 The Result table

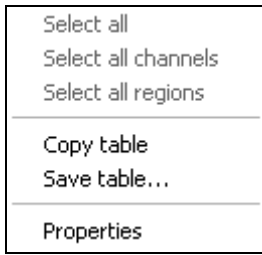


Fig. 305 Result table menu

By clicking with the right mouse button into the **Result** table the table's menu box will pop up (Fig. 305). You have the option to copy the table to the clipboard by selecting Copy, or by choosing save to save the data as a text file. Please note that the options **Select all**, **Select all channels** and **Select all regions** is currently not available.

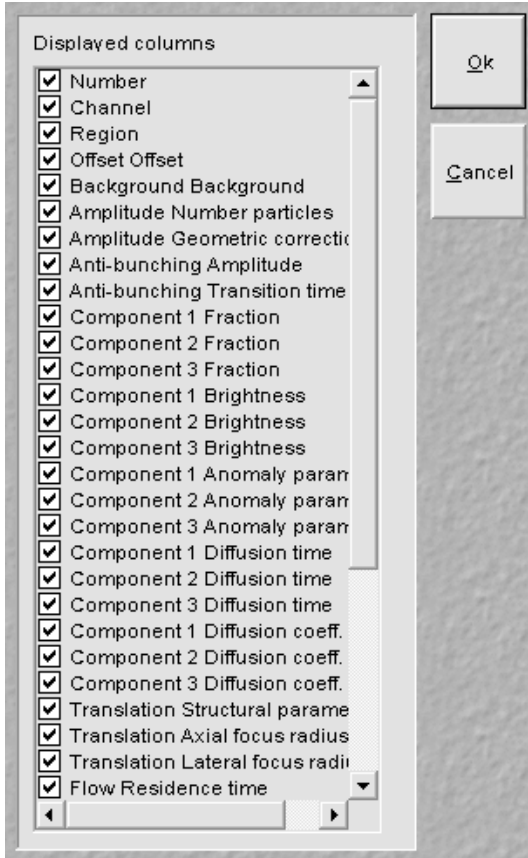


Fig. 306 Properties sub menu

By selecting **Properties** the **Properties** submenu will appear (Fig. 306). The table lists all available parameters. You can select the parameters you want to have displayed in the result table by checking the corresponding boxes.

If the **Show parameter limits** check boxed is ticked, the **Upper limits** and **Lower limits** columns are displayed in the Fit table, otherwise they are not visible. If the **Show standard deviations** check box is ticked, standard deviation for floating parameter values are displayed, otherwise they are suppressed.

Pixel dwelling times in μs and line times in ms of the scan are displayed in the **Pixel times in μs** and **Line times in ms** input boxes in the **Show all** mode. They are read from the Meta data of the image and are fixed values for the Fit. If you want to simulate with other numbers, they can be entered in the input boxes via the arrows or typing. Note, if numbers are changed and the image saved under the same name, the real values will be lost. Pixel sizes in μm are only accessible from the **Information** register.

The **Skip pixels** input box in the **Show all** mode allows setting the numbers of spatial lag pixels that should be omitted for the Fit. The number can be entered by typing or using the arrows.

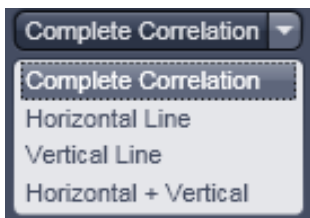


Fig. 307 Fit mode pull down menu

With the **Fit mode** input box, only available in the **Show all** mode, the data set for fitting can be defined (Fig. 307). You can select between fitting the **Complete Correlation**, the **Horizontal Line** only, the **Vertical Line** only, or the combined **Horizontal + Vertical** lines.

In the **Show all** mode, the size of the Pixels in x and y dimensions are shown in the **Pixel size display area**. Note that the sizes cannot be edited.

6.18.6 Model Functionalities

Activate **Model** under the **RICS** view. The **Model** options will be displayed in the View control window (Fig. 308).

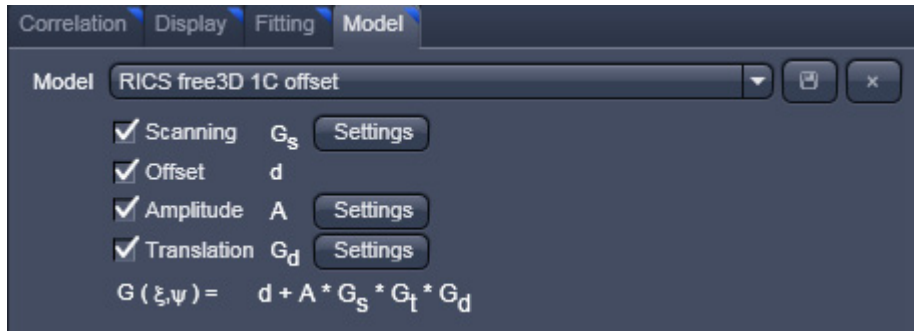


Fig. 308 Fit control window

With the **Model** pull down menu you can select a saved pre-defined model from the list. You can rename a created or changed model by typing in a new name in the display box. If the **Ok** button is pressed, the model will be saved under the new name (Fig. 309). If the model name was not changed, you will be prompted to acknowledge to overwrite the old existing one in the **Save Model Warning** menu (Fig. 310). Press **Yes** to overwrite, **No** to keep the old model.

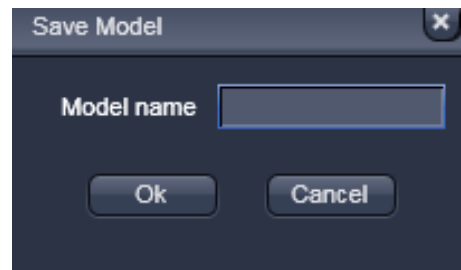


Fig. 309 Model Save menu

Type in a name in the **Model name** display box and press **Ok**, if you want to save the model, or press **Cancel** without saving. You can delete a model by pressing the **Cross** button. You will be prompted to acknowledge the action within the popped up **Delete Model** menu (Fig. 311). Press **Yes** to delete, **No** if the model should be kept.

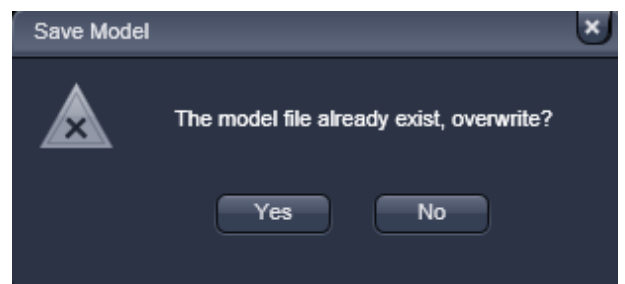


Fig. 310 Save Model Warning menu

Below the Model pull down box the available terms to assemble a model are listed. If you want to take a term into account, check the corresponding box. Four terms are available: **Scanning** G_s , **Offset** d , **Amplitude** A and **Translation** G_d . The assembled model will be displayed in the spatial correlation $G(\xi, \psi)$ display area.

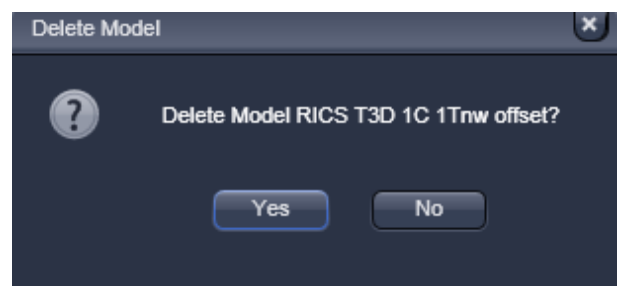


Fig. 311 Delete Model menu

For three of the terms (G_s , A and G_d) settings menus are available. To open a settings menu, press the corresponding **Settings** button.

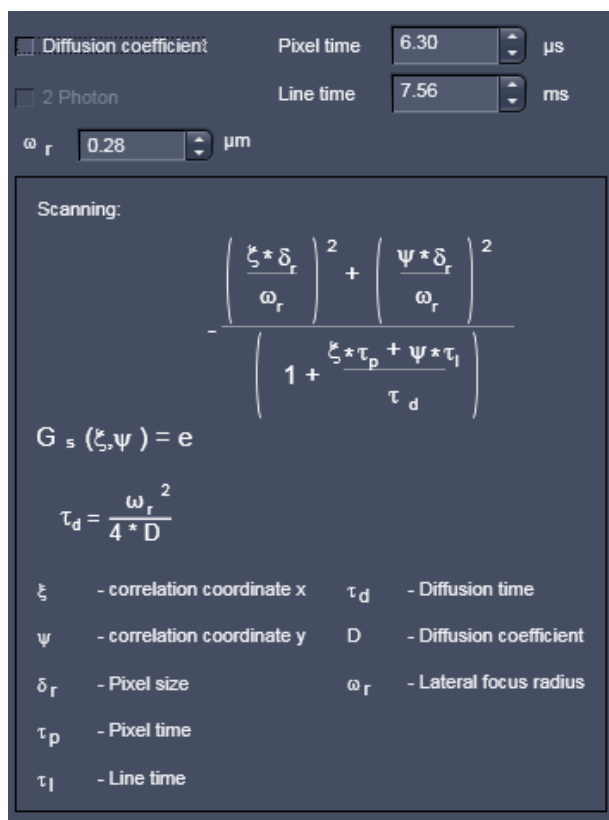


Fig. 312 Settings for the Scanning term

Scanning $G_s(\xi, \psi)$ describes the scanning term of the model function. Scanning is only active in the **Show all** mode. To open the **Scanning** settings press the **Settings** button (Fig. 312).

If the **Diffusion coefficient** check box is ticked, the diffusion coefficient will be fitted, otherwise the diffusion time. In case the box is checked, the **2 Photon** check box will be accessible. If ticked diffusion time scales with 1/8th of the diffusion coefficient, if un-ticked with 1/4th. The 1/e² radius of the laser beam can be entered within the **ω_r in μm** input box by typing or using the arrows. Pixel dwelling times and line times can be entered in the **Pixel time in μs** and **Line time in μs** input boxes. These values are useful for simulations when fixed. They will be overwritten with the correct Meta data from the image, whenever an image is loaded. If these Meta data are not available, values have to be provided. In the **Scanning information** box the formulas for the Scanning term $G_s(\xi, \psi)$ and the conversion formula between diffusion time τ_d and diffusion coefficient D are displayed as well as a description of the parameter variables.

Offset d describes any scalar added to the correlation function. It will be necessary, if the correlation function does not decay to zero.

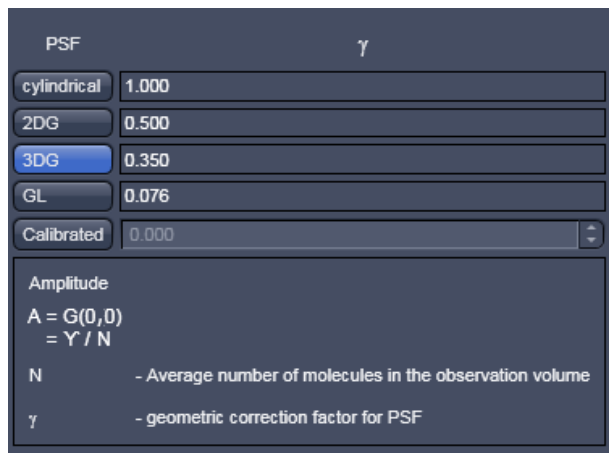


Fig. 313 Settings for the Amplitude term

Amplitude A describes number of particles taking into account the form of the point spread function in relation to the studied structure expressed in the geometric correction factor γ . To open the **Amplitude** settings press the **Settings** button (Fig. 313). You can select a **cylindrical** PSF with $\gamma=1$, a two dimensional Gaussian (**2DG**) PSF with $\gamma=0.5$, a three dimensional Gaussian (**3DG**) PSF with $\gamma=0.35$ or a Gaussian-Lorentzian (**GL**) PSF with $\gamma=0.076$ by pressing the respective button. Alternatively, if **Calibrated** is active, you can enter a calibrated value via the **Calibrated** input box.

In the **Amplitude information** box the formulas for the Amplitude term A is displayed as well as a description of the parameter variables.

Translation $G_d(\xi, \psi)$ describes the translational diffusion term of the model function. To open the **Translation** settings press the **Settings** button (Fig. 314).

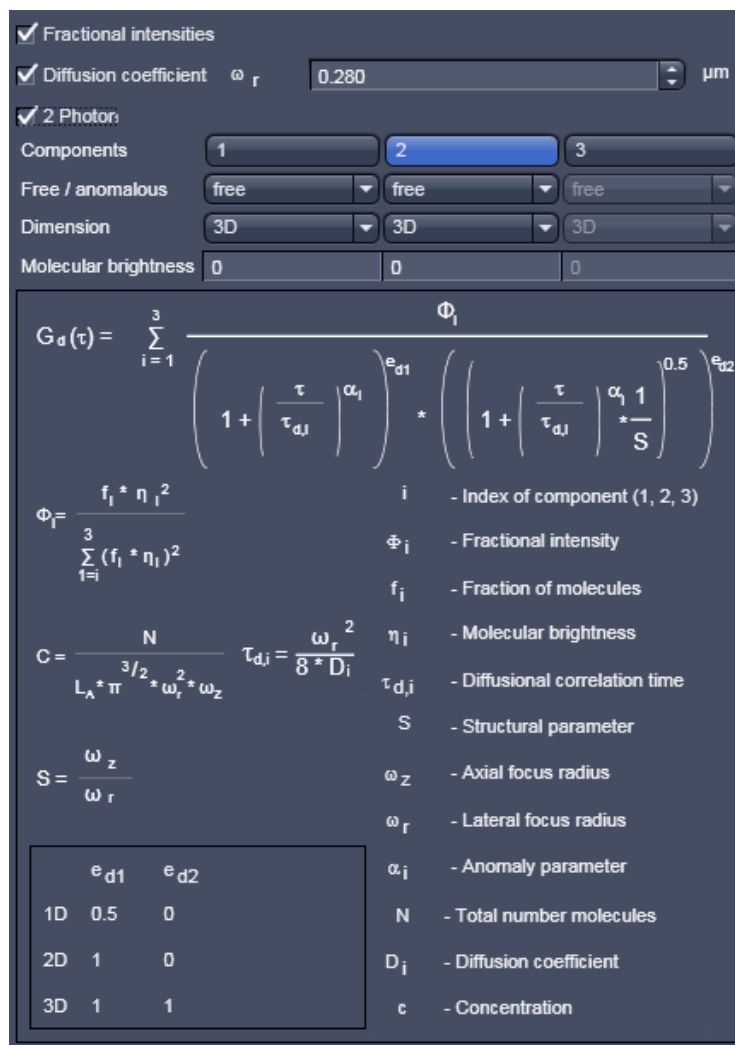


Fig. 314 Settings for the Translation term

If the **Fractional intensities** box is checked, the **Molecular brightness** input boxes will become available. Enter the absolute or relative molecular brightness of the molecules, which have to be determined beforehand. If unchecked, molecular brightness will not be taken into account and the **Molecular brightness** input box will not be displayed.

If the **Diffusion coefficient** check box is ticked, the diffusion coefficient will be fitted, otherwise the diffusion time. In case the box is checked, the **2 Photon** check box will be accessible. If ticked diffusion time scales with $1/8^{\text{th}}$ of the diffusion coefficient, if un-ticked with $1/4^{\text{th}}$. The $1/e^2$ radius of the laser beam must be entered within the ω_r in μm input box, which is also displayed only in case the Diffusion coefficient box by typing or using the arrows.

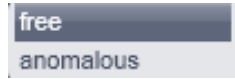


Fig. 315 Free anomalous pull down menu

Components allow selecting **1**, **2** or **3** components by pressing the respective button. **Free / anomalous** allow via pull- down menus to select between free translational or anomalous translational diffusion for each component (Fig. 315).

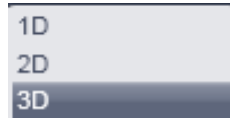


Fig. 316 Dimension pull down menu

Dimension offers selection via pull down menus of one-, two- or three-dimensional diffusion (Fig. 316).

In the **Translation information** box the formulas for the general translational term $G_s(\xi, \psi)$ and useful conversion formulas are displayed as well as a description of the parameter variables.

6.19 Polarization Imaging

Linear (plane) polarized light, which is light whose wave goes only one direction, exciting a fluorescent molecule with a preferred dipole orientation results in polarized emitted light. It provides a contrast-enhancing method that is especially useful in the study of molecules that are fixed in their orientation or are greatly restricted in their rotational diffusion. Anisotropy is directly related to polarization and is defined as the ratio of the polarized light component intensity to the total light intensity.

In polarization microscopy using the LSM 710 and LSM 780 systems the sample is irradiated with vertical polarized light (in respect to the optical table) from a laser source. The emitted fluorescence is passed sequentially through emission polarizers (analyzers) that are housed in the **Notch filter cascade** and that transmit either the vertical (I_{VV}) or horizontal (I_{VH}) polarized emitted light onto the Quasar detector (L format fluorescence polarization). Since the vertical component of the emission light is parallel polarized to the vertical polarized excitation light, it is often also referred to as the parallel component ($I_p, I_{||}$). Likewise, the horizontal polarized emission light is also designated as the perpendicular ("senkrecht" in German) component (I_s, I_{\perp}). In the Software the "p" and "s" designations are used.

Polarisation **P** and anisotropy **r** are defined as:

$$P = \frac{I_p - I_s}{I_p + I_s} \text{ and } r = \frac{I_p - I_s}{I_p + 2 \cdot I_s} \text{ with } 0 \leq r \leq 1.$$

Hence they can be interconverted to each other in the following way:

$$P = \frac{3 \cdot r}{2 + r} \text{ and } r = \frac{2 \cdot P}{3 + P}.$$

In a completely polarized sample ($I_s=0$) the anisotropy $r=1$. In a completely non-polarized sample ($I_s=I_p$) anisotropy $r=0$.

The formulas for polarization **P** and anisotropy **r** as given above are strictly true only, if the optical transmission for both emission polarizers are identical. Any differences must be corrected by introducing a correction factor **G** that is multiplied with I_p . Hence the anisotropy **r** in such a case would be calculated according to:

$$r = \frac{I_p - G \cdot I_s}{I_p + 2 \cdot G \cdot I_s}$$

G can be measured using horizontally polarized excitation light and is defined as

$$G = \frac{I_{HV}}{I_{HH}}.$$

However, since in the LSM 710 and LSM 780 systems the polarization of the excitation light can not be changed easily from vertical to horizontal, G has to be determined with an isotropic fluorescent dye solution as the ratio between the intensities I_p and I_s .

As the formulas implies:

Anisotropy **r** is the preferential display as anisotropy of single species will be simply additive. Note that the ZEN Software provides for a formula to display the anisotropy directly in ratio imaging. Images could also be computed in the **Processing** tool's **Calculator**.



Fig. 317 Light path with Notch filter control button

6.19.1 Light Path for Polarization Imaging

In case emission polarizers (analyzers) are available, you have a **Notch filter cascade** selection button available situated on top of the MBS button (see Fig. 317).

Set up a multitrack configuration using exactly the same settings with the exceptions of the analyzers. To this end press the **Notch filter cascade** button. This opens up the **Polarizer selection box**. Check the polarizer which you want to use with track 1. The options are **P** (for the parallel polarized light transmission) and **S** (for vertical polarized light transmission) (see Fig. 318).

If you want to ratio image, then it is best for convenience to choose **P** for track 1. Check the other polarizer for track 2.

For ratio imaging this would be **S**. For ratio imaging check the **R1 channel box** and assign **Source 1** to the selected channel-T1 and **Source 2** to the selected channel-T2. You can use the single PMTs **Ch1** and **Ch2** or the spectral detector **ChS**.



Fig. 318 Light path with Notch filter cascade option

6.19.2 Determination of G-factor

In order to determine the G-factor for the LSM 710 and LSM 780 systems, you need an isotropic medium like a fluorescent dye at a 1 mM concentration, for example fluorescein. Use the multi track configuration with P and S analyzers selected and with a beam path and channel settings appropriate to your dye. Take a single image and activate in the **Channel** tab the **Ratio** track. In the **Ratio** panel select **Ratio Type 1**. Set all editable summands to 0 and all factors to 1 (see Fig. 319).

For an inverted microscope, use for convenience a glass bottom dish and pipette enough solution in to cover the glass well. For an upright stand, squeeze a drop of solution between the glass bottom dish and a cover slip.

If you have chosen **P** in the Notch filter cascade for Track 1 and assigned it to Ch1-T1 and **S** for track 2 assigned to Ch1-T2 then the G factor is the mean intensity value of the R1 channel. For display activate the **Histo** register of the Image and select the R1 channel (see Fig. 320).

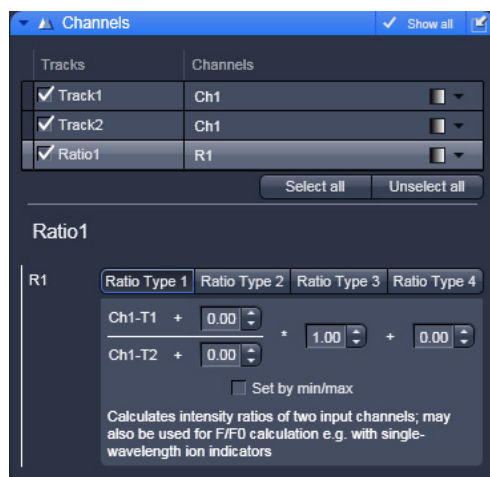


Fig. 319 Channels panel with and Ratio Type 1 formula in the Ratio1 channel selected

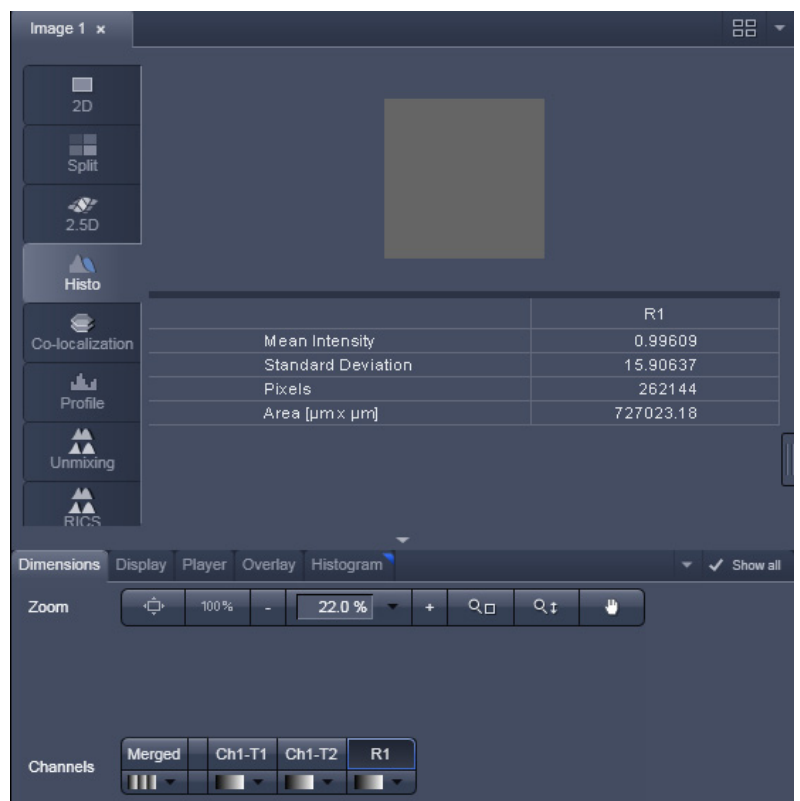


Fig. 320 Histogram display with Ratio1 channel activated

The G-factor is therefore defined as:

$$G = \frac{Ch1 - T1}{Ch1 - T2} = \frac{I_P}{I_S}$$

6.19.3 Obtaining an Anisotropy Image

Set up a multitrack configuration with alternating analyzers: **P** in track 1, **S** in track 2, leaving all other settings equal (see Fig. 321). Assign track 1 to **Ch1-T1**, track 2 to **Ch1-T2**. Alternatively assign to Ch2-T1 and Ch2-T2 or ChS1-T1 and ChS1-T2, whatever physical channel you want to use.



Fig. 321 Channels control with Ratio Type 3 formula selected in the Ratio1 channel using a G factor of 1.18

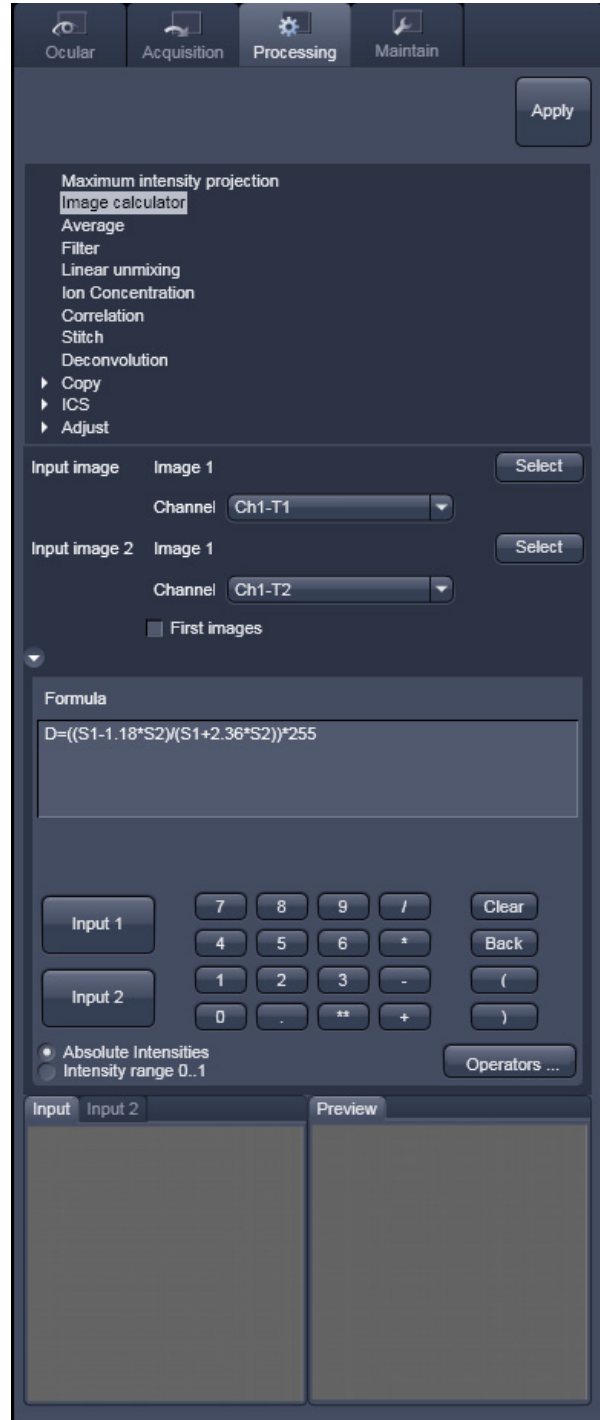


Fig. 322 Image calculator with anisotropy formula and a chosen G-factor of 1.18 with absolute intensities selected

In the **Ratio1** channel choose the **Ratio Type 3** formula. With Ch1-T1 and Ch1-T2 corresponding to I_p and I_s this formula corresponds to the formula for anisotropy r . For the factors put in the value for the G-factor in the numerator and $2 \times G$ in the denominator. Scale by Min/Max by checking the **Set by min/max** box and entering **0** in the **Min input box** and **1** in the **Max input box**. With a corresponding look up table like rainbow this will produce a false colored anisotropy image in the nRatio1 channel.

Alternatively you can use the image calculator with source 1 (S1) being the **P** track image (Ch1-T1) and source 2 (S2) the **S** track image (Ch1-T2) with consideration of the G-factor (see Fig. 322).

Proceed as follows. In the **Processing** tab select the **Image calculator**. Press **Select** and click on the desired input image. In the **Channel** pull down menu of **Input Image Image 1** select **ChX-T1**, where X stand for 1, 2 or S. Accordingly, in the **Channel** pull down menu of **Input Image Image 2** select **ChX-T2**.

Type in the anisotropy formula considering the G-factor of the system. Choose either Absolute Intensities in case you have to multiply the formula with $2^n - 1$ to rescale to an n bit image. For example, if the color depth was 8 bit, multiply with $2^8 - 1 = 256 - 1 = 255$. Alternatively, choose **Intensity range 0..1**, in which case you do not multiply with an extra factor. Press **Apply** and choose a respective look up table to obtain a false colored anisotropy image.

6.20 Information View

The **Information View** is a view type that shows a summary information sheet of all relevant image acquisition parameters. Parts of it can be edited – like, e.g., the **Notes** field.

The Information View displays:

- File Name of the data set
- A brief description of the data set
- A Notes field in which the user can note down essential information on the experiment
- The user name of the person who acquired the image
- The pixel scalings in X, Y, Z
- The image size (pixels in x-y-z, channels, bit depth)
- Calibrated Dimensions x-y-z in μm
- The scan mode (e.g., stack)
- The zoom factor
- The objective lens
- The pixel dwell time of the scan
- The average mode used
- The Gain (Master) settings for all channels
- The Digital Gain settings for all channels
- The Digital Offset settings for all channels
- The pinhole sizes
- The filters and beam splitters in the beam path
- The used lasers with the transmission of the respective AOTF



Fig. 323 Information View of a 2 channel Z-Stack

7 Right Tool Area, Data Management and Storage

7.1 General

Document Type

Images are stored as files (*.lsm format) in folders just like in any other Windows application.

Further Information about the .lsm file format for developers and programmers are available in a .pdf document in the ZEN installation folder.

In ZEN there are three ways to access your data:

- The File menu
- The ZEN File Browser
- Open Images are accessible in the Right Tool Area

The traditional LSM databases have been replaced by

- the ZEN file browser and
- the Information View tab (see section **Information View**) in the image.

ZEN File Browser

The File Browser allows access to image data of variable image formats and permits displaying them in three views:

- Gallery View,
- Table View and
- Form View.

Images can be loaded, copied and deleted within the ZEN File Browser.


The **Re-use** (see section **Dimensions**) function is available in the ZEN Image Browser: Hardware parameters can be loaded without opening the files by clicking the **Re-use** button.

Open Images

In the Right Tool Area the **Open Images** section is displaying the images which are loaded in the system memory. Double clicking brings the image to the front. Files can be saved and deleted/closed on this section.

Export

With the **Export** dialog in the **File** menu, the acquired data can be directly exported to various file types.

 In the **Save As** dialog in the **File** menu these formats can also be chosen as file type.

7.2 ZEN File Browser

The ZEN File Browser is a versatile tool to access your image data.

- In the menu bar, click on **File** and select the **New File Browser ...** item to open the **ZEN File Browser**.

It displays the hard drives and connected network drives available on the computer. Clicking on a folder opens it and lists the image files therein.

The ZEN File Browser can be operated in three views:

- Gallery View,
- Table View and
- Form View.

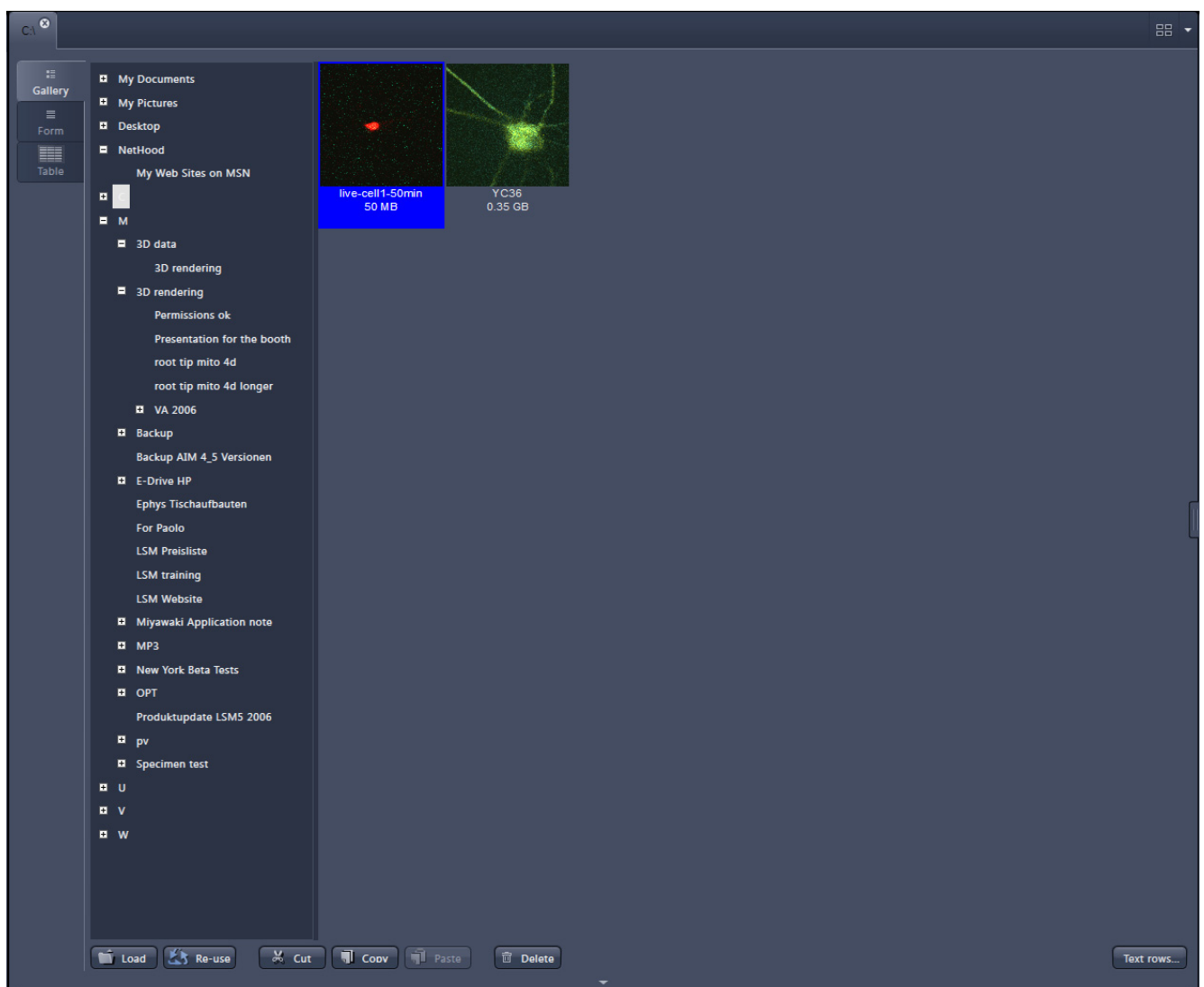



Fig. 324 ZEN File Browser

With the use of the button bar underneath the files can be loaded, cut, pasted and deleted.

Pressing the **Re-use** button loads the hardware settings of the .lsm image highlighted (blue) in the browser window. You do not have to open the image to apply the **Re-use** function.

 Eventual error messages (Fig. 325) fading in the right hand corner inform about missing hardware if applicable. The message box disappears after ~ 10 seconds.

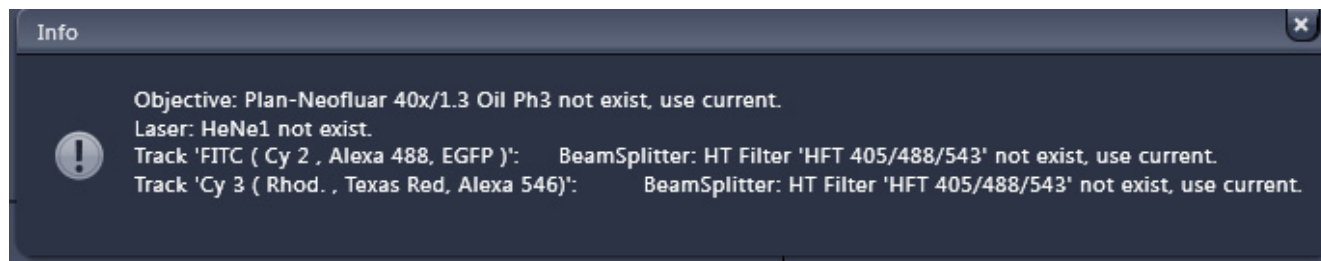


Fig. 325 Error message

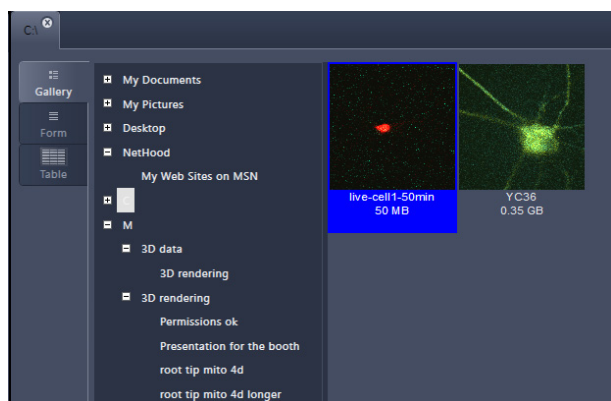


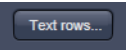
Fig. 326 Gallery view

7.2.1 Gallery View of the ZEN File Browser

In the **Gallery View** of the browser the images are displayed as thumbnails. One click selects a single image, press **Shift** and click to select multiple images. If the **CTRL** key is pressed, all clicked images are selected.

Opening Images:

- To open an image, double click on it.
- For opening multiple images at a time, select the desired images and press **Load**.

The information stored in the .lsm file format can be displayed underneath the thumbnail. By pressing the  button a choice of information is available (see Fig. 327).

The example below (Fig. 328) shows the use of the display of:

- file name,
- acquisition date,
- file size and
- scan mode.

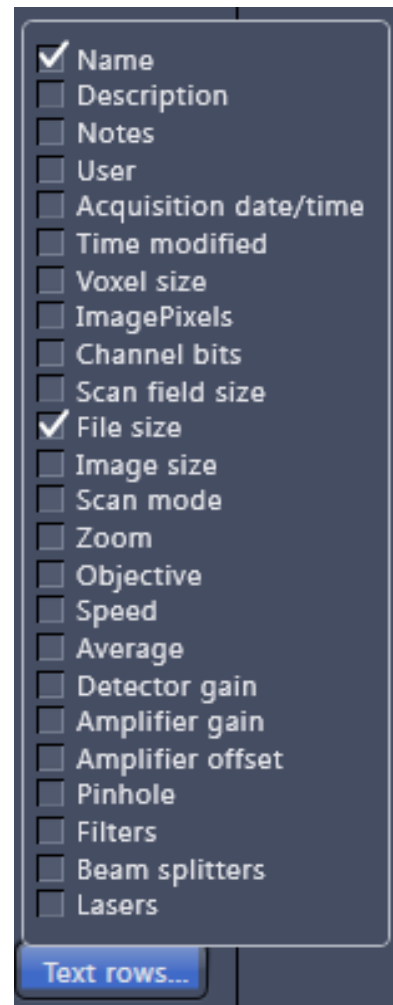


Fig. 327 Image information selection

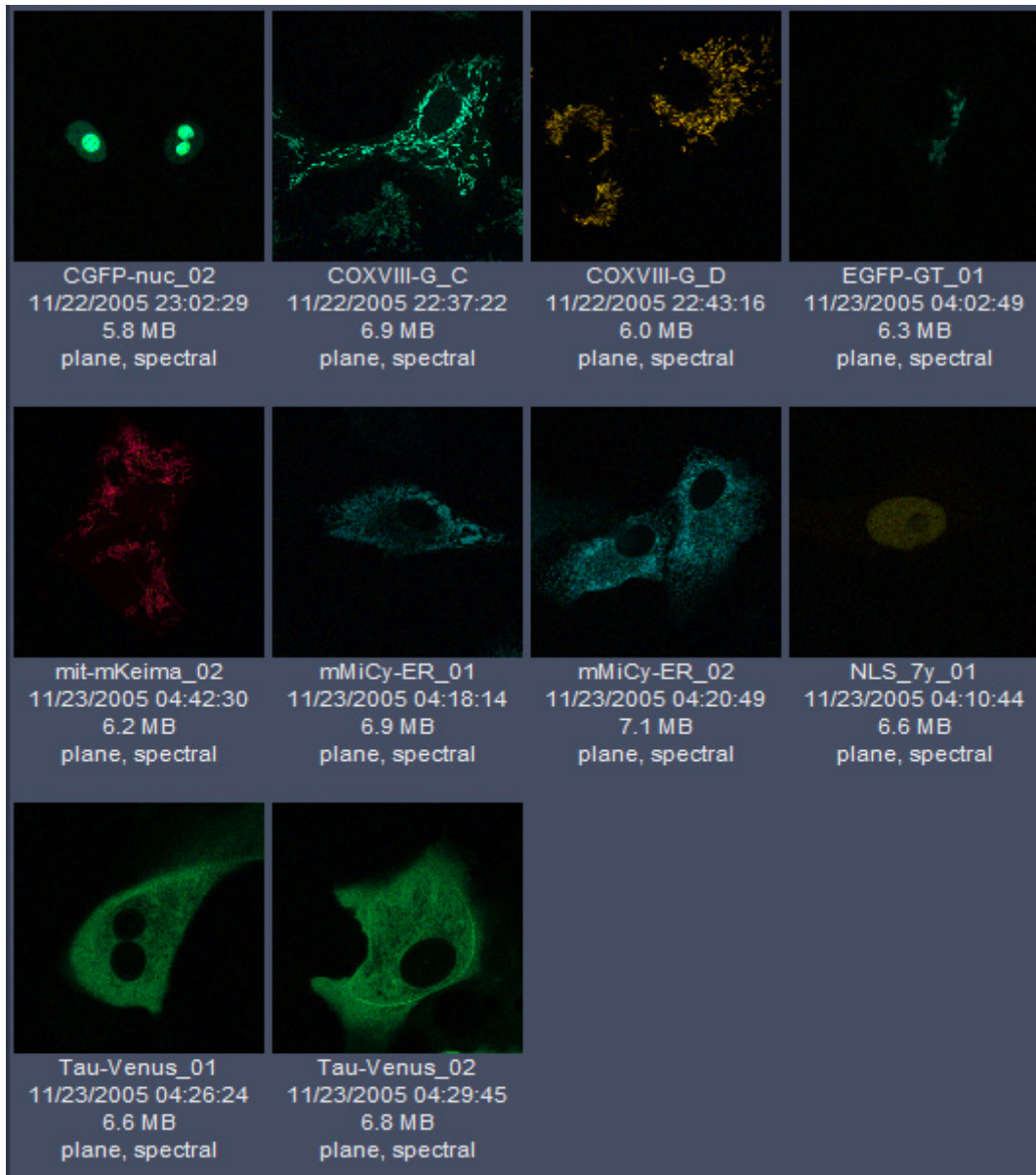
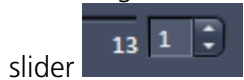



Fig. 328 Images with information

7.2.2 Form View of the ZEN File Browser

All images in a given folder can be accessed by using the slider below the Info-Panel or using the stepper on the right side of the slider. The total number of images in a folder is indicated on the right side of the



slider. In the **Form View** of the browser all information available (or entered) in the **Info-tab** of the image is displayed.

 Note that the upper four fields (**Name**, **Descriptions**, **Notes** and **User**) are currently not saved. To edit these fields please load the image and edit the form in the info-view of the image. The information in those fields are – however – accessible by copy and paste.

The buttons for copying and loading images underneath are available in the Form view as well.

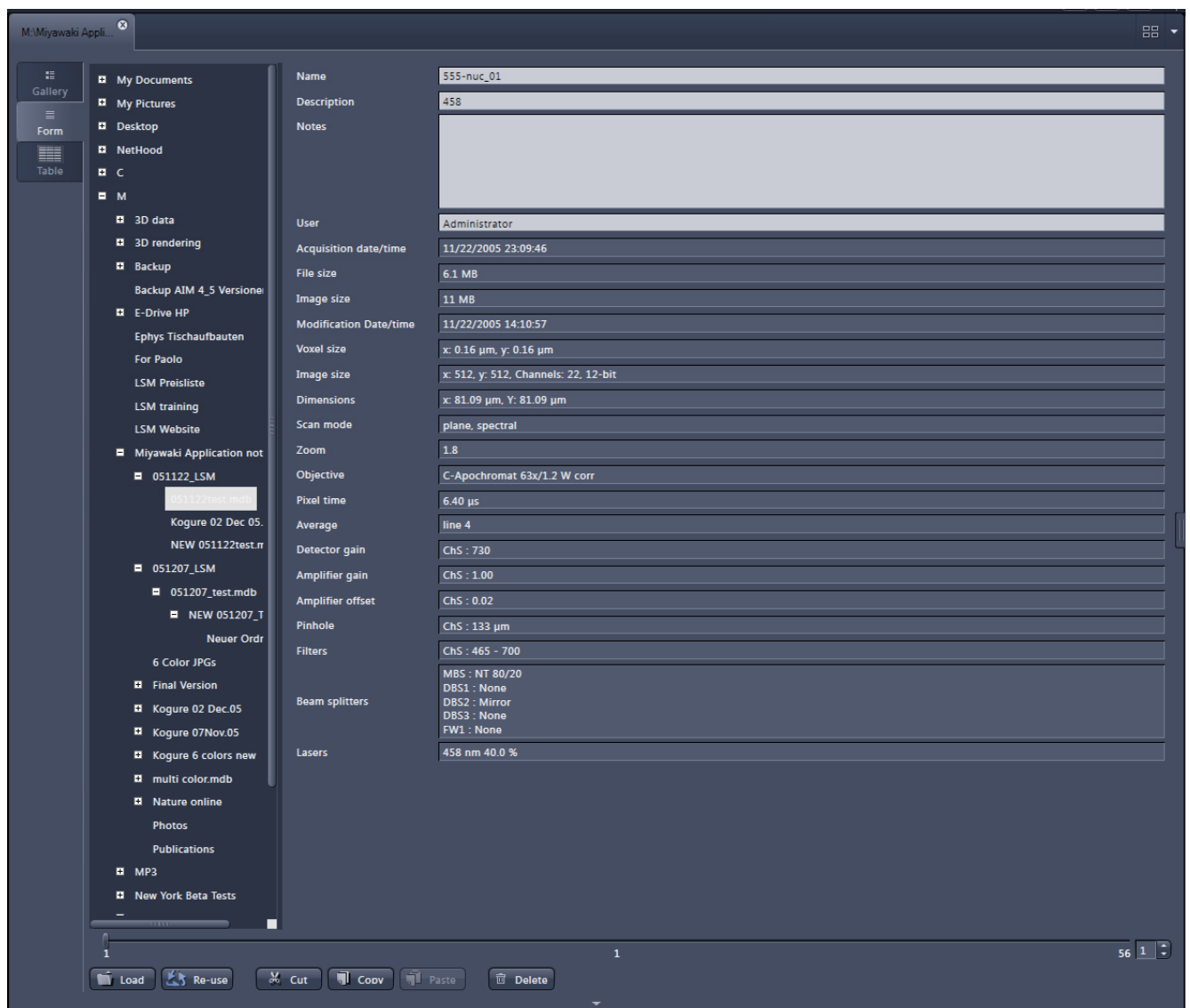


Fig. 329 Form view

7.2.3 Table View of the ZEN File Browser

The **Table View** is especially useful in case a lot of files are found in one folder.

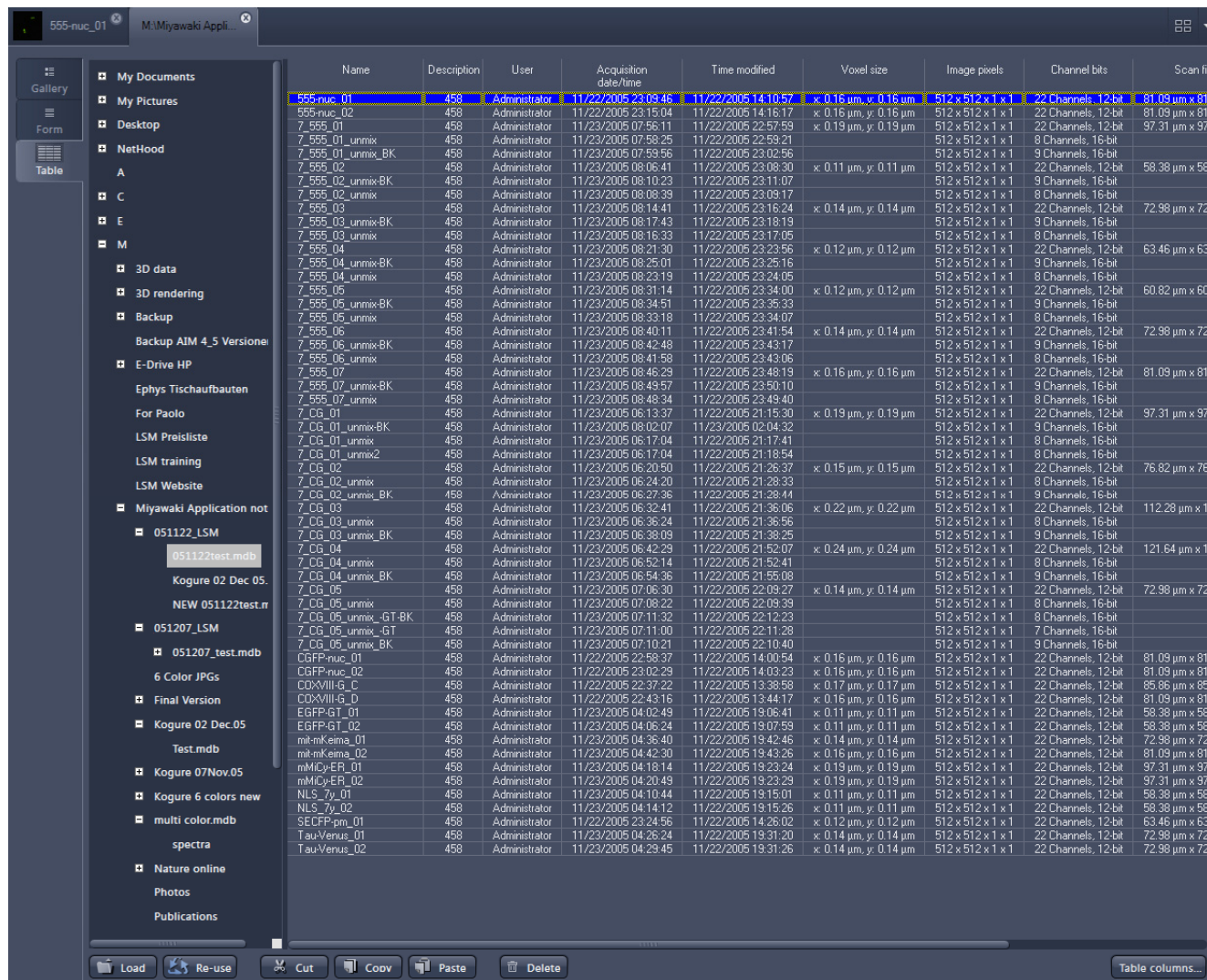


Fig. 330 Table view

The columns displayed in the table are selectable from the **Table columns** button. The options shown in Fig. 331 are available.

The width of the columns is editable and the order of the columns can be freely shifted by dragging the header of the columns.

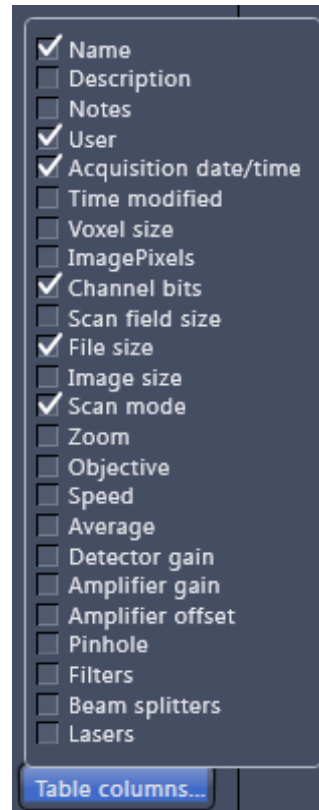


Fig. 331 Table view options

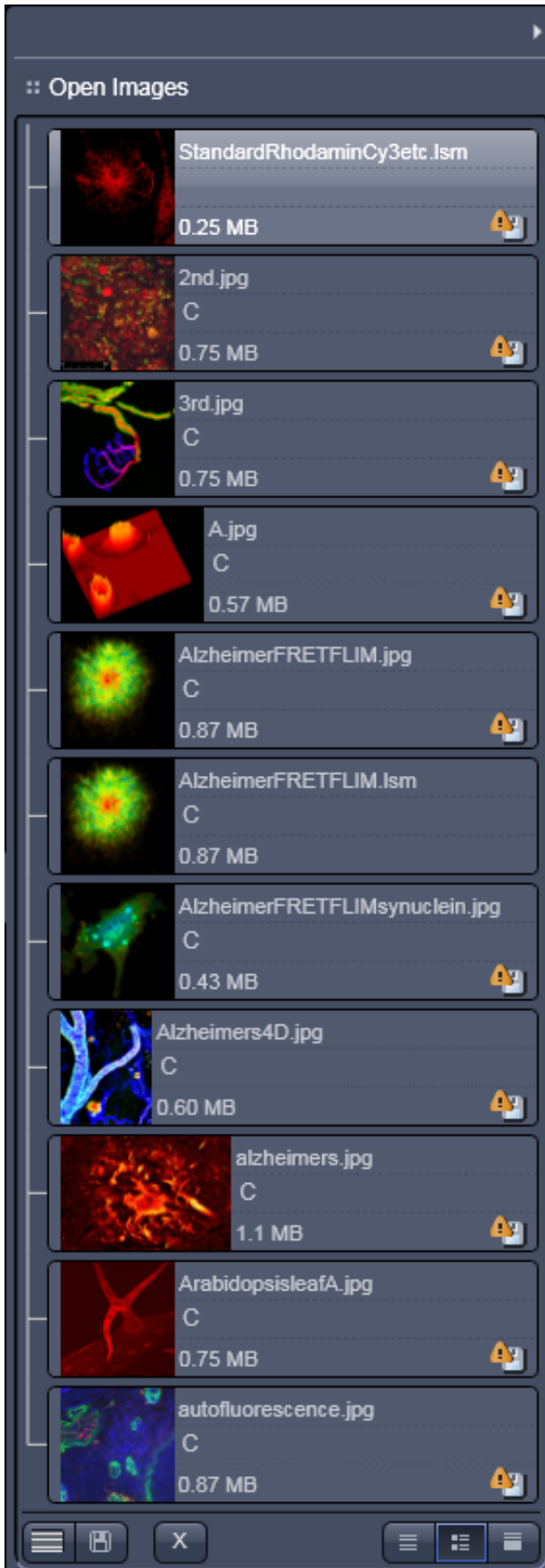






Fig. 332 Open Images section


7.3 Open Images




The **Open Images** section (Fig. 333) is located in the Right Tool Area of ZEN. It displays all images and data which are open in ZEN. Its purpose is multi-fold:




- All opened images can be brought to the front by double clicking on them which makes the navigation through lots of images easy and fast.
- Basic file handling functions are implemented for fast operation with the acquired images. The images can be saved and deleted using the following buttons:  

- A new acquisition document can be opened using the  button.

- On already saved images the  button is closing the image, not deleting it. Multiple images can be selected by holding down the **CTRL** key on the keyboard and clicking on the list entries.

- The whole section can be hidden by clicking on the white triangle above the section . Once hidden, a click on the right boarder of ZEN lets the **Open Images** section slide back into the application.

- All files can be displayed in three ways by using the    buttons underneath the section.

-  Textual View
-  Thumbnail View
-  Big View

The default setting is **Thumbnails view** as indicated on the screengrab.

- The context menu of the **Open Image** section allows the following functions:
 - Selecting one of the view options **Textual View**, **Thumbnail View** or **Big View**
 - Selecting all opened image files by clicking on **Select All**
 - Opening a **New Acquisition Document**
 - Saving or closing the selected image files by clicking on **Save** or **Close**

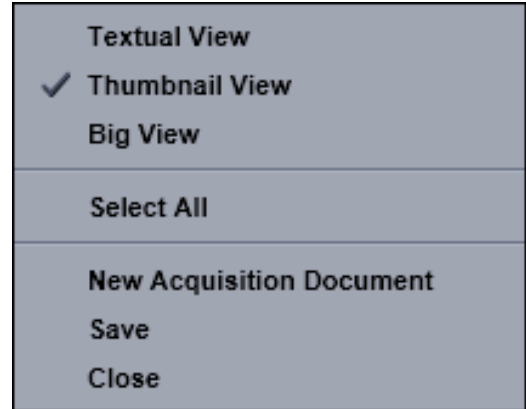





Fig. 333 Context menu of the Open Images section

Regardless of which display type is chosen, the individual images contain the following information:

- File name
- Data type indicated by icons:    like e.g. **Stack**, **Time**, **Bleach**, **Lambda** or **C** for multichannel images. These icons are the same as underneath the start button when starting multidimensional experiments (section **Action Buttons**).

The file size is indicated in MB or GB.

- Example of a 2 Ch. Z-Stack displayed with a small thumbnail in the **Open Images** section (Fig. 334).

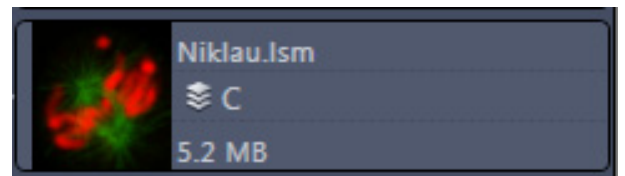


Fig. 334 2 Ch. Z-Stack image

- In case the image is not saved or has been processed, a warning symbol is displayed on the right side (Fig. 335).

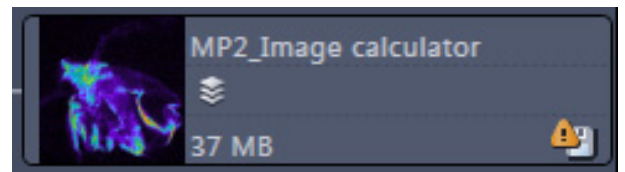


Fig. 335 Image with warning symbol

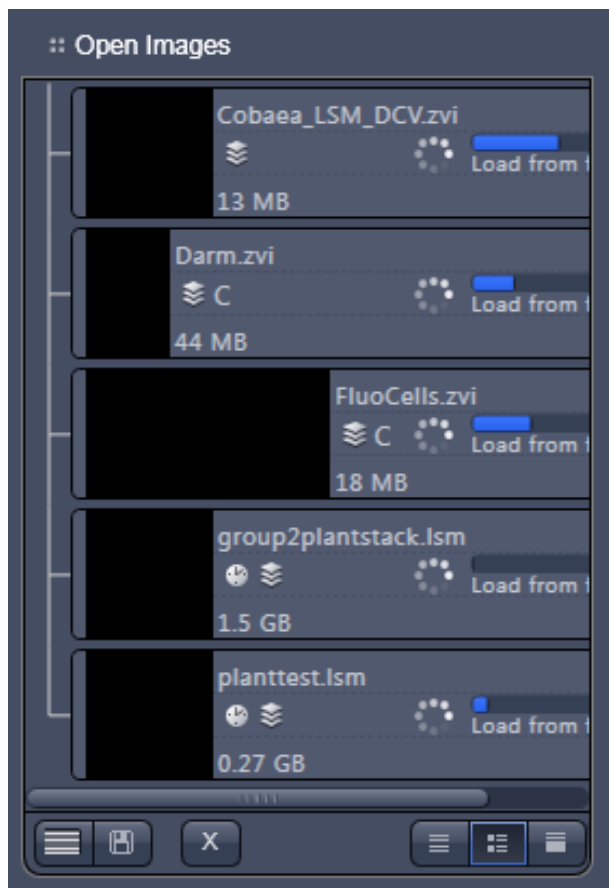


Fig. 336 Image progress bar

- A progress bar (Fig. 336) is shown for each image facilitating the overview if e.g. many processing function are running at the same time.

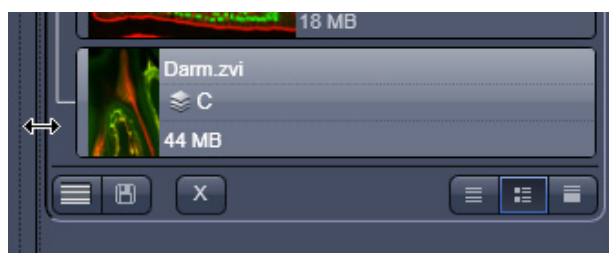



Fig. 337 Enlarging the image view

- In case long filenames are used the whole section can be dragged to the left and thereby enlarged (Fig. 337).


7.4 Opening of Files via the "Open" Command in the File Menu

- Click on the **File** menu of the menu bar and select **Open** or click on the  icon of the main toolbar.
 - The standard windows open dialog appears.
- Select the desired file and click **Open**.

7.5 Save

The **Save** function allows to store an image together with the acquisition parameters (and processing information) to be stored in a .lsm file.

Proceed as follows to save an acquired or an edited / processed image:

- Click on the **Save** or **Save As** button in the **File** menu of the menu bar or click on the  icon of the main toolbar.
 - The **Save Image and Parameter As** window appears on the screen.

Save:

Stores a newly created or changed image. Newly created images must be given a name

Save As:

Stores a previously stored and called up image under a different name. If images are called up and stored again, the original data and time display will be retained.

Clicking on either of these Menu Items opens the **Save As** window to create and open an image database.

Click on the **OK** button in the **Save Image** window.

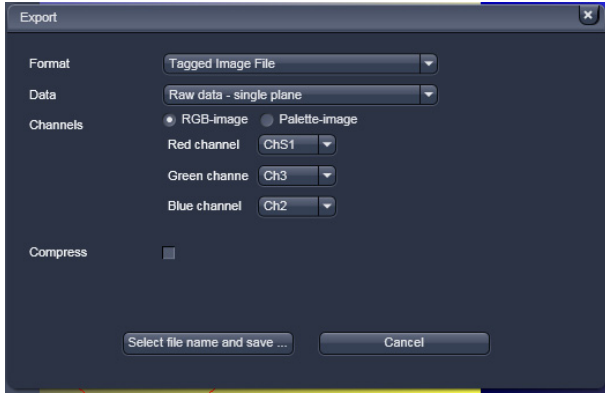


Fig. 338 Export window

7.6 Export of Images

The **Export** function allows the export of acquired images and images loaded

- Select the image to be exported.
- Click on the **Export** menu Item in the **File** menu of the menu bar
 - This opens the **Export** window (Fig. 338).

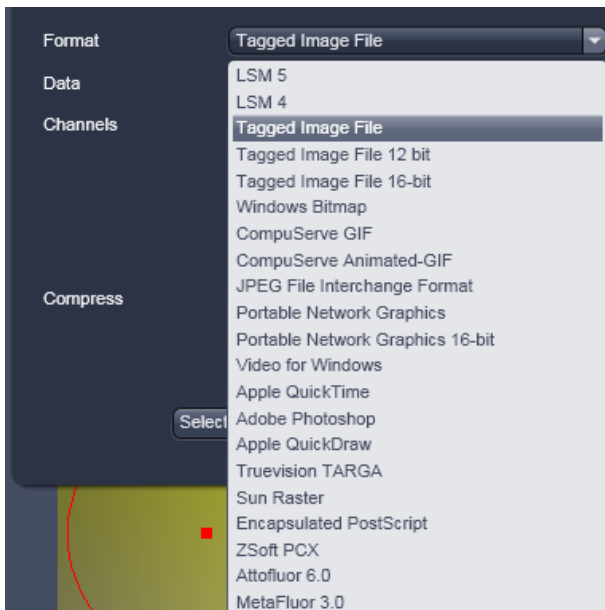



Fig. 339 Format selection



Fig. 340 Data type selection

- Under **Format**, select the format to which the image is to be exported to (Fig. 339).

- Select the data type which the image is to be exported under **Data** (Fig. 340).
- Chose a compression level. For some file formats lossless compression or various other compression levels are available. The degree of losses for the image quality is listed according to the type of compression.
- Click on the **Select file name and save ...** button. The standard Windows File saving dialog appears. Click **Save** to complete the export process.

 When stacks or time series are exported, each frame is stored as an individual image.

8 Index

2

2D View 158

3

3D distance measurement 172
 3D View basic 195
 3D *VisArtplus* 176
 Maximum 182
 Mixed 183
 Rendering settings 188
 Shadow projection 178
 Surface 182
 Transparency 181

A

Acquisition 52
 Action button 34, 52
 Adjust 137
 Animation 162
 Application bar 25
 Ar laser 15
 Arrow down button 40
 Auto Exposure 103
 Automatic Component Extraction 244
 Average 69, 110
 Average 76
 Axio Examiner control 51
 Axio Imager control 44
 Axio Observer control 48

B

Band filter 112
 Big view button 41
 Bleaching 91
 Brightness 162

C

Camera color adjustment 29
 Center screen area 38
 Channels 160
 Channels tool 79
 Clipping planes 184
 Settings 187
 Close button 41
 Colocalization 199
 Container 40
 Context menu 37, 39, 40
 Contrast 162

Coordinate label 166
 Correlation 113
 Crop 161

D

Depth coding 182
 Dichroic beam splitters 60
 Digital Gain 104
 Digital Offset 104

E

Exiting ZEN 18
 Expand slider 41
 Export of images 284
 Expose mode 39

F

File 27
 Filter 111, 112
 Flying mode 188
 Focus tool 82
 Frame 68, 76
 Frame 67
 FRAP 226
 FRET view 234

G

Gamma 162

H

Hardware control tools 43
 HDR function 70
 HDR offline mode 112
 Hide button 42
 Histogram 196

I

ICS 115
 ICS correlation 116
 Map filter 118
 Remove structures 115
 Image
 Export of an 284
 Saving an 283
 Image calculator 108
 Image control area 39
 Image information 42
 Image optimization 100
 Image tabs 39

Image view controls.....	39	Select.....	171
Image view tabs	39	P	
Imaging configuration	35	Pinhole adjustment.....	141, 144
Imaging setup	57	Polarization Imaging	265
Information On Experiment	97	Processing	
Ion concentration	124	Brightness.....	137
K		Channel shift	139
Kinetic.....	226	Contrast.....	137
L		Filter	111
Lambda coded.....	232	Image calculator.....	108
Large thumbnail view	40	Image duplication	135
Laser tool	55	Interpolate	137
Left tool area.....	34, 43	Maximum intensity projection	107
Light path.....	60	Processing of images	105
Line	67	Profile.....	203
Linear unmixing.....	119	R	
LSM options	151	Range indicator	160
M		Ratio channels	81
Main tool tabs	34	Regions	84
Main toolbar	31	Reuse	161
Maintain.....	28	RICS	246
Administrator.....	29	Right tool area.....	41
Spline	28	S	
Test grid	29	Save button	41
Maintain tab.....	141, 147	Save Status icon.....	42
LSM options.....	151	Saving an image	283
Objectives	147	Scan control	67
Pinhole adjustment	141, 144	Scatter diagram	201
Marker	94	Separate view controls.....	40
Maximum intensity projection.....	107	Series.....	190
MBS	60	Series, modify.....	114
Mean of ROI.....	222	Settings	193
Median filter.....	111	Shading correction.....	140
Menu bar	25	Shared view controls.....	40
Menu overview.....	26	Sharpen filter.....	112
Multidimensional image acquisition	36	Show all function.....	36
Multiple columns layout	36	Shutdown.....	14
Multiple tracks.....	62	Shutdown procedure	18
N		Sliders.....	60
New image document button	41	Small thumbnail view.....	40
O		Smart Setup.....	35, 53
Objectives.....	147	Smooth filter	112
Ocular tab	43	Spline	28
Open images	280	Spot	67
Ortho		Spot, creation of a	78
Distance.....	172	Stage.....	83
		Starting ZEN	17
		Startup	14

Statistical confidence	122
Status bar	33
Stitch	130
Subset	136
System startup	14

T

Text view	40
Textual view button	41
Thumbnail view button	41
Tile scan	95
Time series	93
Tool	36
Tool groups	34
Tool window	35, 36
Tools	35
Topography	206
3D Topo	210
3D Measurement	221
Display	207
Measurement	212
Series	221
Transmission	101
Turning power off	18

U

Undock function	36
Unmixing view	239

V

View control	
Dimensions	158
Display	162
Overlay	163
Player	162
View type	
2.5 D	174
Cut	173
Gallery	169
Ortho	170
Preview	167
Split	168

W

Weighted unmixing	121
Workspace configuration	31
Workspace zoom	25

Z

ZEN File Browser	27, 273
Form view	277
Gallery view	274
Table view	278
Z-Stack	86

CHAPTER 5 MACROS AND VISUAL BASIC

CONTENTS

	Page
5 MACROS AND VISUAL BASIC.....	2
5.1 Macros.....	2
5.1.1 Macro Language	2
5.1.2 Macro Control	3
5.1.3 Overview of Available Macros	8
5.1.4 Sample Macros	9
5.1.5 Kollimatic.....	10
5.1.6 OptimizeLIVE Macro.....	19
5.1.7 Image Match (Scanfield Transformation) Macro.....	20
5.1.8 Visual Macro Editor	22
5.2 VBA PROGRAMMING FOR LSM	33
5.2.1 VBA Programming	33
5.2.2 Programming for LSM	39

5 MACROS AND VISUAL BASIC

5.1 Macros

The macro function permits the recording, running and editing of command sequences and their allocation to buttons in the **Macro** menu. Macros can be set up in two different ways: The Visual Macro Editor or alternatively they can be programmed in Visual Basic directly.

- In the **Menu** bar (see Fig. 1), click on **Macro**.

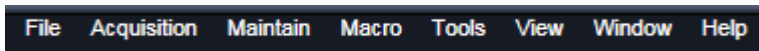


Fig. 1 Menu bar

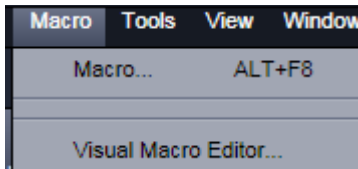


Fig. 2 Macro menu

- This displays the **Macro** menu (see Fig. 2).
 - The Macro list is bipartite: **Macro** – editing and recording of macros; assign macros to list
 - **Visual Macro Editor** – edit automatic workflows with pre-defined modules

Selecting **Macro** opens a dialogue for editing and recording Macros based on VBA programming in the **Macro Control** window (see Fig. 3). VBA programming is described in Section 5.2 of the printed manual.


Using the **Visual** Button (optional) allows to create automated work flows using the arrangement of symbols which depict the single steps within a work flow. See **Visual Macro Editor**, page 22 for further details.

5.1.1 Macro Language

"Visual Basic for Applications", called VBA in the following, is used as the Macro language. This language is well known and widely used as Macro language in the "Microsoft Word for Windows" and "Microsoft Excel for Windows" products. Experience with "Microsoft Visual Basic" would also be beneficial for macro-programming ZEN.

An Integrated Development Environment (IDE), the "Microsoft Visual Basic Editor", is available for editing and debugging of macros. The IDE includes an "online help" with a detailed description of the VBA language.

Macros are stored in project files. One project file can include several macros.

 **The VBA functionality described in this paragraph refers to VBA as implemented in the Carl Zeiss LSM software 4.2. With the introduction of ZEN, the range of functions is and will be extended, while VBA can still be used with the functions described below. The extension of functionality applies mostly to display and access of image data. If you need assistance or further information please contact your local Carl Zeiss LSM specialist:**

5.1.2 Macro Control

To open the Macro Control, choose **Macro** from the **Macro** List in the main **Menu Bar**.

This opens the **Macro Control** window.

5.1.2.1 Edit Macro Function

This function allows you to manage project data. Macros can be recorded, stored, performed, edited and, if required, deleted.

- Press the **Edit Macro** tab to switch to the **Macro** and **Recording** panels (see Fig. 3).

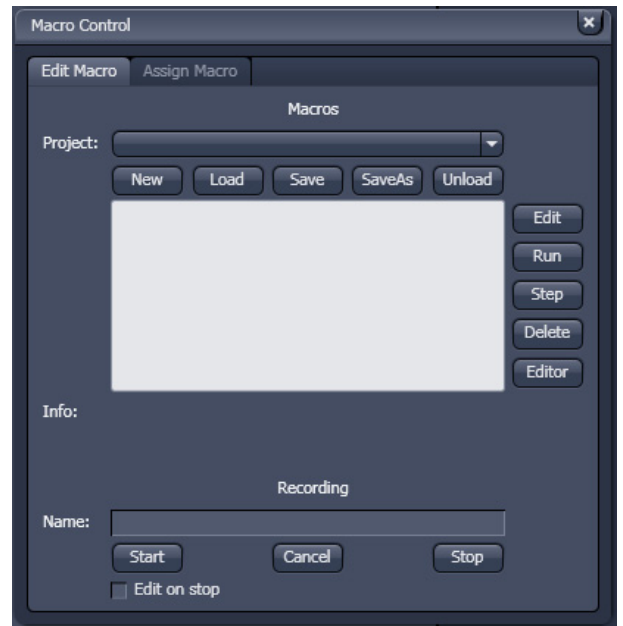


Fig. 3 Macro Control window

(1) Macro panel

New button: Creates a new project.

Load button: Opens an existing project.

Save button: Stores the project on the hard disk.

Save As button: Stores an existing project under a new name.

Unload button: Removes the selected macro from the **Macros** list.

Edit button: Allows macros to be edited and debugged. The editor (**Microsoft Visual Basic**) is automatically located at the beginning of the relevant macro.

Run button: Runs a macro.

Step button: Opens the editor for line-by-line editing / debugging.

Delete button: Deletes the selected macro.

Editor button: Opens the editor. Displays the processed area of the macro edited last.



Fig. 4 Macro panel with new Macro assigned

Macros are stored and managed in project files (*.lvb). Before you can record or edit a macro, you have to create a project as follows:

- Press the **New** button to create a project file.
 - A new project is created and displayed in the **Project** selection box. The project name is automatically default (LSM followed by a number), but can be edited afterwards.

To activate an existing project, proceed as follows:

- Press the **Load** button.
 - The **Open** window will be opened (see Fig. 5).
- Select the relevant project file (data extension: ***.lvb**) from the **Macros** list box. Click on the **Open** button.

- The project file will be opened and the macros contained in it are displayed in the **Project** selection box of the **Macro Control** window. You can use the pull down menu to load any listed Macro.

Recorded macros are stored in main memory first. Before the macros can be assigned to the list in the **Macro** submenu, the project must be stored on the hard disk.

- Press the **Save** button under the project name in the **Macro Control** window and determine the file name in the **Project** selection box, if required.

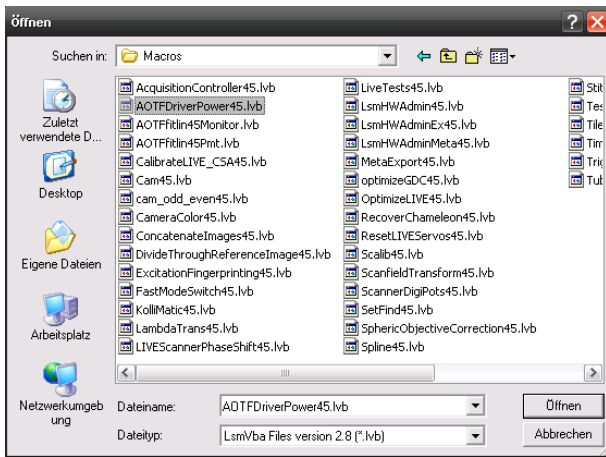


Fig. 5 Open window



Fig. 6 Macro panel with existing Macro assigned

(2) Recording panel

Before recording a command sequence, you can enter the name for the macro to be created in the **Name** input box of the **Recording** panel.

Start button: Starts recording.

Cancel button: Cancels the recording procedure.

Stop button: Stops recording.

Edit On Stop: On stopping the recording procedure, the macro editor is automatically opened at the relevant position.

Proceed as follows to record a macro:

- Enter a name for the macro to be created under **Name** in the **Recording** panel.
- Click on the **Start** button to start recording the macro.
- Then perform the operations to be stored, e.g.:
 - Click on the LSM **Auto Exposure** action button. A find scan will be performed.
 - Click on the LSM **New** action button. A new **Image Display** window will be opened.
 - Click on the LSM **Snap** action button. A scan will be performed.
- Then click on the **Stop** button to end the recording. (**Cancel** enables you to cancel recording)
 - If recording was successful, the entered **Name** will then also be available in the **Macros** list box of the **Macro** panel. The new macro is automatically assigned to the current project. It is possible to assign as many macros as required to a project.
- Click on the **Save** button to store the new macro.

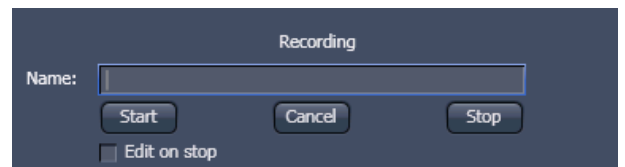



Fig. 7 Recording section

Proceed as follows to run a macro:

- Select the required macro from the **Project** list box of the **Macros** panel.
- Click on the **Run** button to start performing the macro.

 Provided that a macro is linked to a list in the **Macro** section of the **Menu Bar**, you only need to click on its name to perform it.

Proceed as follows to delete a macro:

- Select the required macro from the **Project** list box of the **Macros** panel.
- Click on the **Delete** button. The macro will be removed from the list.

Proceed as follows to edit a macro:

- Select the required macro from the **Project** list box of the **Macros** panel.
- Click on the **Edit** button. The Microsoft Visual Basic editing window will be opened.
- Make the required changes.

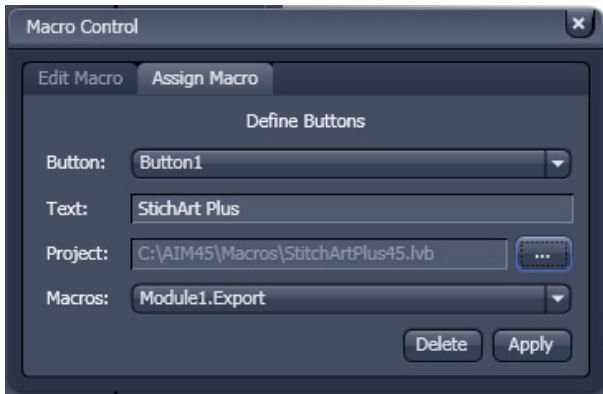


Fig. 8 Macro Control window – Assign Macro

5.1.2.2 Assign Macro to the Macro list

This function permits stored macros to be linked to the assigned Macros list in **Macro** of the **Menu Bar**.

- Press the **Assign Macro** tab to switch to the **Assign Macro** panel (see Fig. 8).

Define Buttons panel

Proceed as follows to link a macro to the **Macro** list:

- Select the button number corresponding to the position in the list from the **Button** selection box.

- Enter the button labelling in the **Text** editing box.
- Select the name of the project file from the **Project** box using the "..." button.
- Select the macro name from the **Macros** box.
- Press the **Apply** button to assign the relevant macro to the specified list position in the **Macro** toolbar.

Delete a macro from the Macro list

Proceed as follows to delete the linking between a **Macro** list position:

- Select the button number from the **Button** selection box.
- Press the **Delete** button to delete the list entry.

5.1.2.3 Editing and Debugging of Macros

The **Edit** in the **Edit Macro** panel button activates IDE (Integrated Development Environment), which allows macros to be edited and debugged. Under the **Help - Microsoft Visual Basics Help** menu item, IDE contains detailed "online" help on its operation and on the VBA macro language. Therefore, only a few hints are provided in the following:

You should activate the required toolbars. We would recommend you to activate the **Debug** toolbar via the **View - Toolbars -Debug** menu item.

The following buttons in the toolbar can help you when debugging macros:



Starts running the command lines.



Stops running the command lines.



Interrupts processing of the command lines (pause).



Sets a breakpoint in the line with the text cursor.



Processes a command line and steps into subprocedures.



Processes a command line and steps over subprocedures.



Exits the subprocedure (step out).



Displays the value of the marked expression (Watch). If nothing is marked, the value of the variable above the text cursor is displayed.



Activates the Watch window in which values of variables and expressions can be displayed. For this, text is marked in the code window and dragged into the Watch window. Variables can be modified in the Watch window.


In the left-hand edge of the code window you will find an arrow beside the current command line. A new current command line can be determined by moving the arrow via the mouse. This makes it possible to skip command lines or to process command lines several times.

5.1.3 Overview of Available Macros

Documentation files (*.rtf, *.doc) of advanced macros will be located in the macro directory.

Name	Description
AOTFfitlin50Monitor.lvb	Linearize laser attenuation (AOTF or mechanical)
AOTFDriverPower50.lvb	Attenuate laser light by the AOTF by additional dampening factors
Autofocus50.lvb	Automatic focusing according to a set configuration
CameraColor50.lvb (also Button in Maintain)	Color balance of Axiocam HRc
Center50.lvb	Centers the field of view around the position marked with the cross tool
ConcatenateImages50.lvb	Enables the combination of all kinds of images irregardless of the size and data depth to be presented in a time series. Imported images can also be included. Type of concatenation (fitted to the smallest frame or ROI, fixed size or fitted to the largest frame) can be defined by the user.
ExcitationFingerprinting50.lvb	Automated generation of excitation lambda stacks for generating excitation spectra which can be used for linear unmixing to separate overlapping dyes. Any detector can be used, also NDDs. Description as guide tour on the installation CD-ROM or DVD.
FRET plus.lvb	(Option) Enables the user to perform FRET experiments based on sensitized emission or acceptor photo bleaching (depending on the type of LSM) including commonly accepted analysis algorithms.
Kollimatic50.lvb	Automatically generates the calibration matrix of a LSM 7 LIVE system for optimal confocal aperture and collimator settings
Lambdatrans.lvb	Time series alternating between lambda and transmission mode
LsmHWAdmin.lvb (also Button in Maintain)	Direct service hardware access (password protected)
LsmHWAdminEx.lvb	Calibration service macro (password protected)
ModifySeriesZEN.lvb	Modifies Z Stacks and Time Stacks like Rotation of the stacks, being mirrored, Conversion of time stacks into z-stacks and vice versa;
StitchArtPlus.lvb	StitchArt Plus macro (Option)
MultiTime.lvb	Set up of time series experiments including repeated imaging, bleaching and autofocusing with defined configurations at multiple locations and for various views at each location (Software option)

OptimizeLIVE50.lvb	Temporarily adjusts the confocal aperture position of a LSM 7 <i>LIVE</i> without changing the general calibration values
RecoveryChameleon.lvb	Imitates recovery of chameleon NLO laser in case the laser is falling into CW lasing and does not get to mode lock anymore.
ScanfieldTransform50.lvb	Adjusts image match relative to each other or to ROIs.
SphericObjectiveCorrection50.lvb	Calibrates the spheric component of objective error by automatic acquisition of a Z stack on a flat surface and a spherical fit of the topographic data.
TestGrid50.lvb	Projects a testgrid into the image window (password protected).
TileScanRotation50.lvb	Defines rotation angle of scanners during tile scan


 During installation, default macros will be installed according to their type either in ZEN\ZEN\HWT or ZEN\Macros\. Self generated Macros will be in ZEN\Macros. In case of a new installation, old macros will be stored in ZEN\Macros\BackupMacros or ZEN\Backup\, to avoid problems with identical names of existing and new macros.

5.1.4 Sample Macros

The ZEN software package includes a set of basic macros free of charge

Other macros from the list (previous page) are part of the product range of Carl Zeiss MicroImaging GmbH. Please contact your sales representative for a quote.

In the following paragraphs you find a short description of some representative and common macros. Please contact your local LSM specialist for more detailed and extensive information.

 **Please check the C:\ZEN\Macros folder on your system for separate documentation in the more extensive macros in .pdf format.**

5.1.5 Kollimatic

This VBA Macro is used to calibrate the LSM 7 *LIVE* on the current system configuration (e.g. objectives, filters, etc.)

Prerequisites


- System Warm-Up (at least 2 hours; for procedure please read the User's Manual) and environmental conditions according to setup requirements.
- "OptimizeLIVE.lvb" Macro: ensure both channel sliders set to 0
- Proper adjustment of collimators and Confocal Slit Aperture (CSA) 1 + 2 (this has to be done by the local Service Representative)
- AOTF RGB + V linearized properly with Macro AOTFFitlin.lvb
- All used objectives are stored in the database according their exact order in the nose piece.
- Necessary calibration slides are available
 - 1x Bead Slide 1 µm for dry objectives, # **000000-1371-460**,
 - 1x Bead Slide 200 nm for immersion objectives, # **000000-1371-461**;
 - to be ordered from Carl Zeiss Jena.

Basic Functions of the Macro

The Kollimatic macro features two main parts, Basic Calibration and Calibration Matrix:

A - Basic Calibration

- Needs to be done only once with one of the recommended objectives (should be part of the shipment in order to be able to repeat the Basic Calibration without calibrating all objectives again (see objective list down below))
- Is for calibrating both collimators RGB + V
- Is for calibrating the Y-position of the Beam Shift Compensator (BSC) for all present NFT positions

 On currently delivered LSM 7 *LIVE* Systems, the Basic Calibration is done in the factory (This can be confirmed by checking that **BasicCalibrationLog.txt** is present in C:\ZEN\Bin).

Objective list (objectives are listed in order of most to least recommended for this calibration task)

- Plan Apochromat 20x / 0.8
- Plan Neofluar 40x / 1.3 Oil
- C-Apochromat 10x / 0.45W
- C-Apochromat 40x / 1.2W corr
- Plan Apochromat 5x / 0.16
- Plan Neofluar 10x / 0.3
- Plan Apochromat 63x / 1.4 Oil
- C-Apochromat 63x / 1.2W corr
- Plan Neofluar 20x / 0.5

B - Calibration Matrix

- Is based on the calibration results of the Basic Calibration
- Needs to be performed for each objective separately
- Is for calibrating the collimator position of both collimators RGB + V only for the selected Objective depending on:
Laser Line, Zoom + EF Filter Position
- Is for calibrating the BSC Y-position depending on:
Laser Line, Zoom + EF Filter Position



On currently delivered LSM 7 *LIVE* Systems, the Calibration Matrix is set up in the factory for every objective belonging to the system (This is done together with the Basic Calibration).

Without running Calibration Matrix, the positions of the collimators and BSC Y should be ok. This is due to the Basic Calibration, but the results are not fully optimized.

Installation of the Macro:

If not already done, copy the required files to the following destinations:

File Name	Destination
KolliMatic.lvb	C:\ZEN\Macros
PotentialKollimaticConfig.ini	C:\ZEN\Bin
KolliMatic_Instructions.pdf	C:\ZEN\Macros

Starting the Macro:

- Start the LSM software and check first, if all prerequisites have been fulfilled (see section Prerequisites)
- Put the appropriate calibration slide (depending on current objective: immersion or non immersion) onto the microscope stage
- Activate all lasers, and using the and focus with the 488 nm line start scanning and focus onto the beads
- Put the appropriate calibration slide (depending on current objective: immersion or non immersion) on the microscope stage, start single scan
- Use the **Macro** menu of the main LSM software to **Load** and **Run** the Macro **KolliMatic** (see Fig. 9)

Please wait a few seconds, the Macro will set up beam path and all necessary settings automatically.

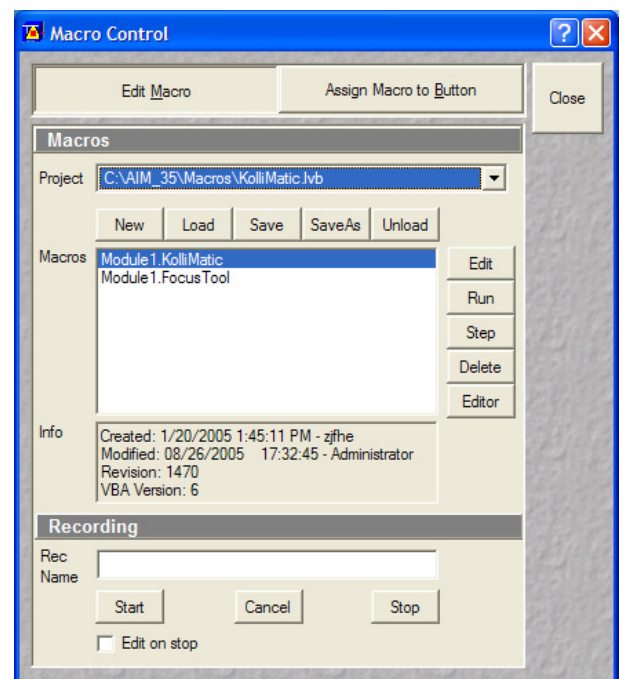


Fig. 9 Macro Control Window of the main LSM Software

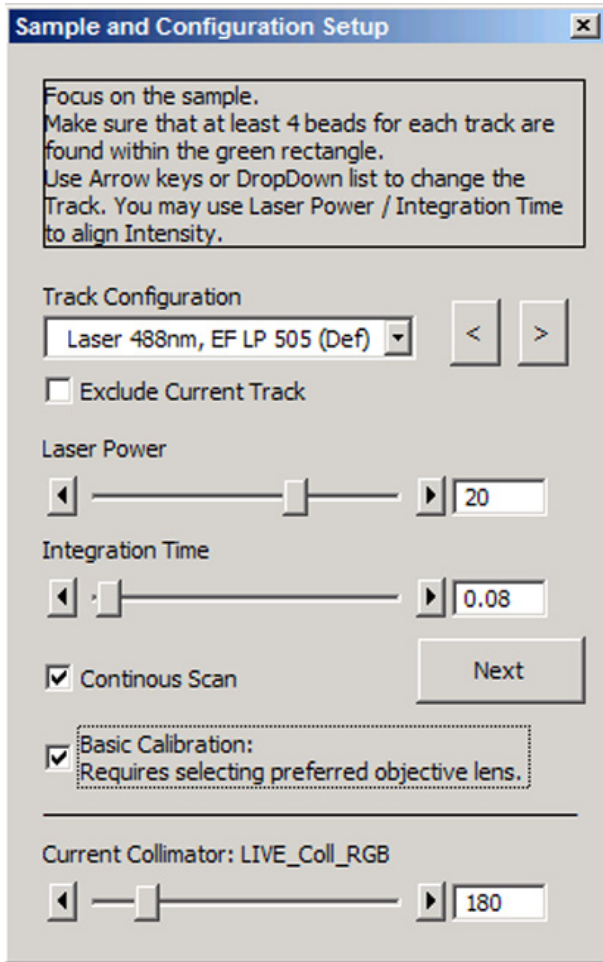


Fig. 10 Figure Sample and Configuration Setup Window of the Kollimatic Macro

Preparations for using the Calibration Slides:

- Follow the steps shown in the macro **Sample and Configuration Setup** window.
- Use the arrows or the drop down menu in order to select one track for each available laser line (no need to select several tracks for the same laser line), start with a track for the lowest wavelength laser (i.e. typically the 405 nm laser line.).
- Select an area of the bead sample that provides as many beads as possible, at least 4 (fit into the green rectangle)
- In Fig. 10, the Basic Calibration has been selected (Check box **Basic Calibration: Requires selecting preferred objective lens.**), therefore some more tracks are available
- Use the **Laser Power** as a first option in order to set the intensity, second option is **Integration Time**.
- In order to start / stop the scan, just select / deselect the check box **Continuous Scan**.
- Focus on the beads.
- Defocus with the **Collimator** slider until the beads become line shaped.
- Focus with the microscope focus drive to get the vertical lines as thin as possible (Fig. 11).
- Now use the **Collimator** slider to get a round spot out of the line (Fig. 12).
- Repeat these steps for a track with the 488 nm laser line.
- After one track for each laser line has been adjusted, click **Next**.

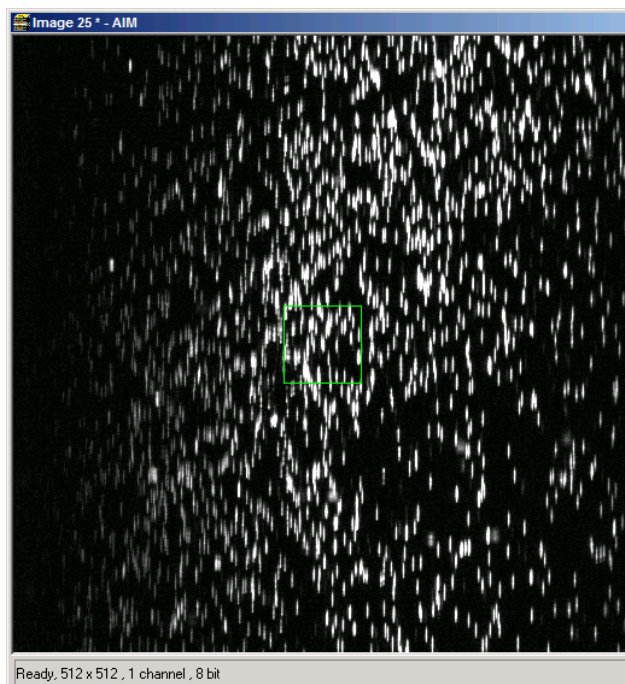


Fig. 11 Beads focused for maximal vertical thinness

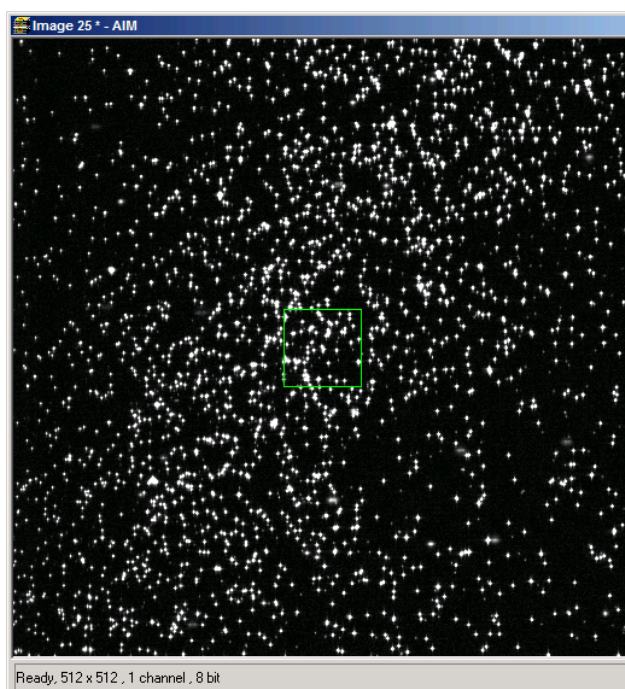



Fig. 12 Beads optimally focused

Running the Basic Calibration

 If you have selected the check box for **Basic Calibration**, please follow these instructions. In order to run the **Calibration Matrix** only, move on to Running the Calibration Matrix.

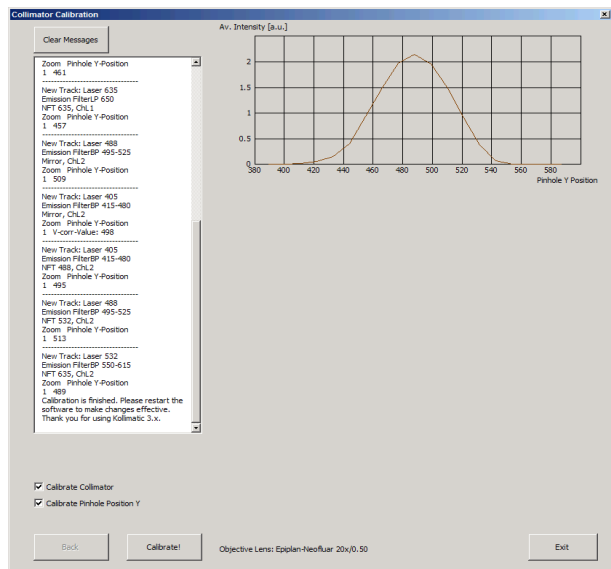



Fig. 13 Collimator Calibration Window

- Make sure that both check boxes have been selected (Fig. 13)
- Double check if the objective settings (shown at the bottom of the macro window) match the currently used objective
- Click the **Calibrate** button
- In order to follow the calibration process, just click into the **Message** window; a scroll bar will appear
- The **Basic Calibration** takes about 15 min
- The displayed curve should resemble a Gaussian profile
- After the macro has finished, a message will pop up with the request to restart the LSM software to make the changes effective.
- Press **Exit** and restart the LSM software

Running the Calibration Matrix

 If you haven't selected the check box for Basic Calibration, the **Calibration Matrix** will be selected automatically. In this case, when the Calibration Matrix is running, the Basic Calibration is disabled.

- This window provides three check boxes (Fig. 14)
- The recommended setting is to select **Create new calibration file**. All previous files will be deleted.

Exceptions:

No check box checked

- Especially after an unexpected interruption of the program, it is possible to continue from the position where the process stopped (saving time).

Overwrite Collimator values

- The values for the chosen objective will be added or updated.
 - After selecting the collimator option, the Pinhole Y option will be selected automatically.
- Double check if the objective settings (shown at the bottom of the macro window) match the currently used objective.
 - Click the **Calibrate** button.

Meaning of the Graph (Figure):

- Brown: Focal plane of the CCD Line Detector
- Red: Focal plane of the collimator
- Orange: Estimated focal plane

The brown and red graphs should be close to this curve.

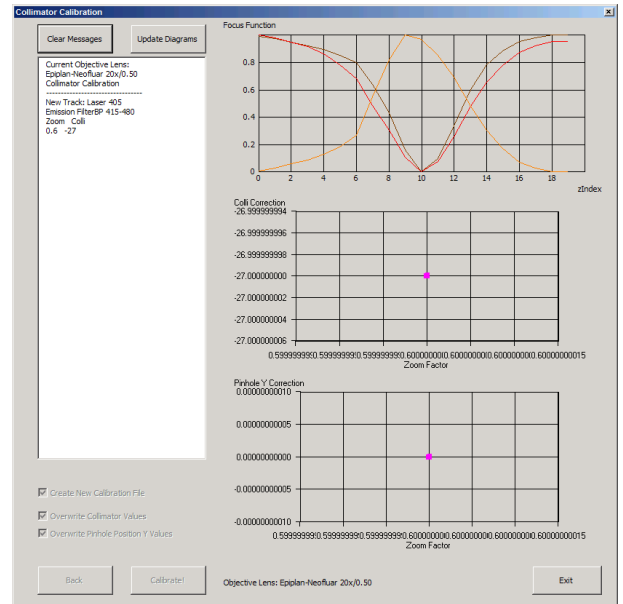


Fig. 14 Running the Calibration Matrix

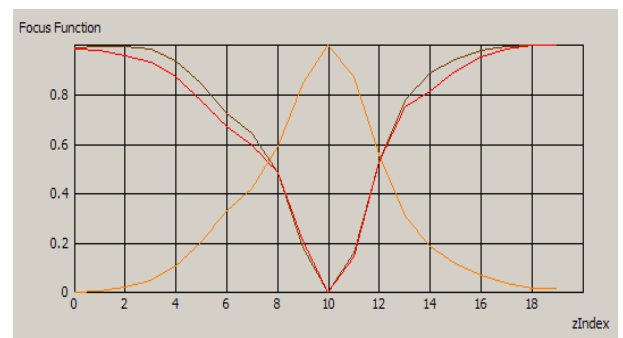


Fig. 15 Graph of Focus Function

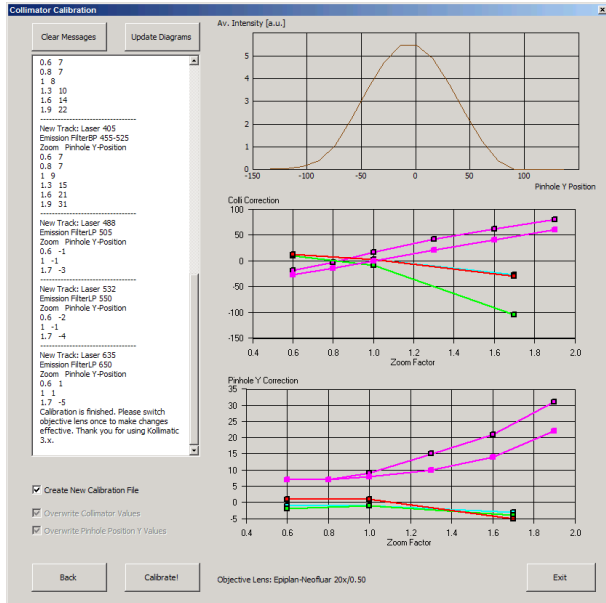


Fig. 16 Collimator Calibration window after calibration

- In order to follow the calibration process, just simply click into the Message Window and; a scroll bar will appear (Fig. 16).
- The Calibration Matrix takes about 25 min for each objective.
- After the macro has finished, a message will pop up with the request to switch the objective lens in order to make the changes effective.
- If necessary, repeat the procedure for the other objectives.
- Use the **Update Diagrams** button in order to check, if an objective has already been calibrated.
 - Select an objective, press the **Update Diagrams** button
 - If no graphs appear, this particular objective has yet needs to be calibrated.
- Click **Exit** to finish.


Meaning of the Graph (Figure):

- Each coloured line represents an individual laser line.
- Each coloured calibration point represents an emission filter.
- Standard graphs are displayed with black points.

Meaning of the Colours:

- <420 nm: → Pink
- 421...475 nm: → Blue
- 476...495 nm: → Turquoise
- 496...550 nm: → Green
- 551...590 nm: → Yellow
- >590 nm: → Red

Important Information!

 If the calibration has been completed successfully with the Calibration Matrix, do no longer use the pinhole and collimator functionality of the LSM software in the **Maintain** menu.

The use of the pinhole sliders to raise the quality of the images is well known from the other LSM Systems.

On the LSM 7 *LIVE*, only the **Optimize** sliders of the **OptimizeLIVE.lvb** macro have to be used (Fig. 17) to compensate for misalignments (e.g. temperature influences).

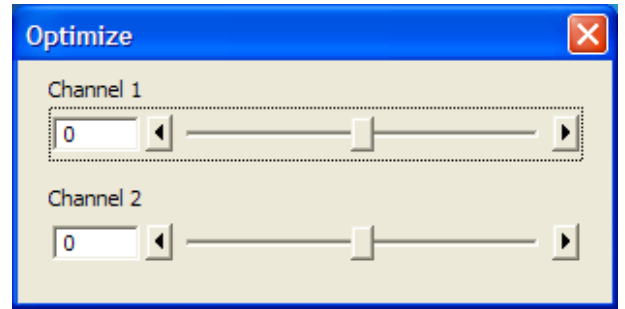


Fig. 17 Optimize Macro

After the Calibration Matrix has optimized a particular objective, the results will be stored automatically in a file as shown below. These files can be found in C:\ZEN\BIN.

 Do not change any of the values!

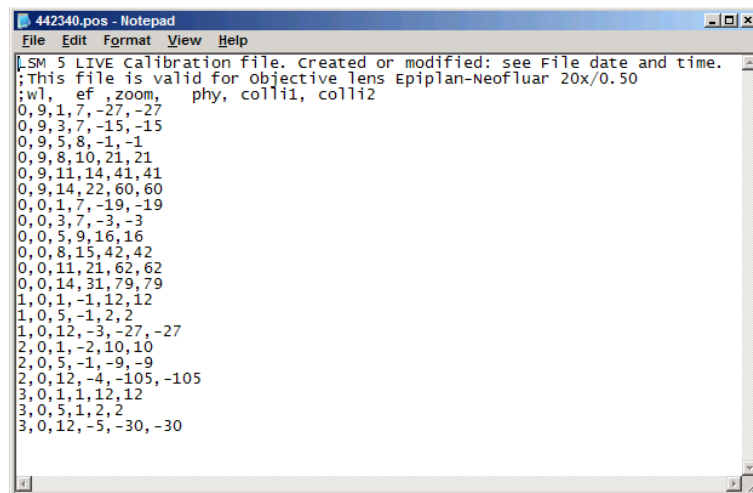
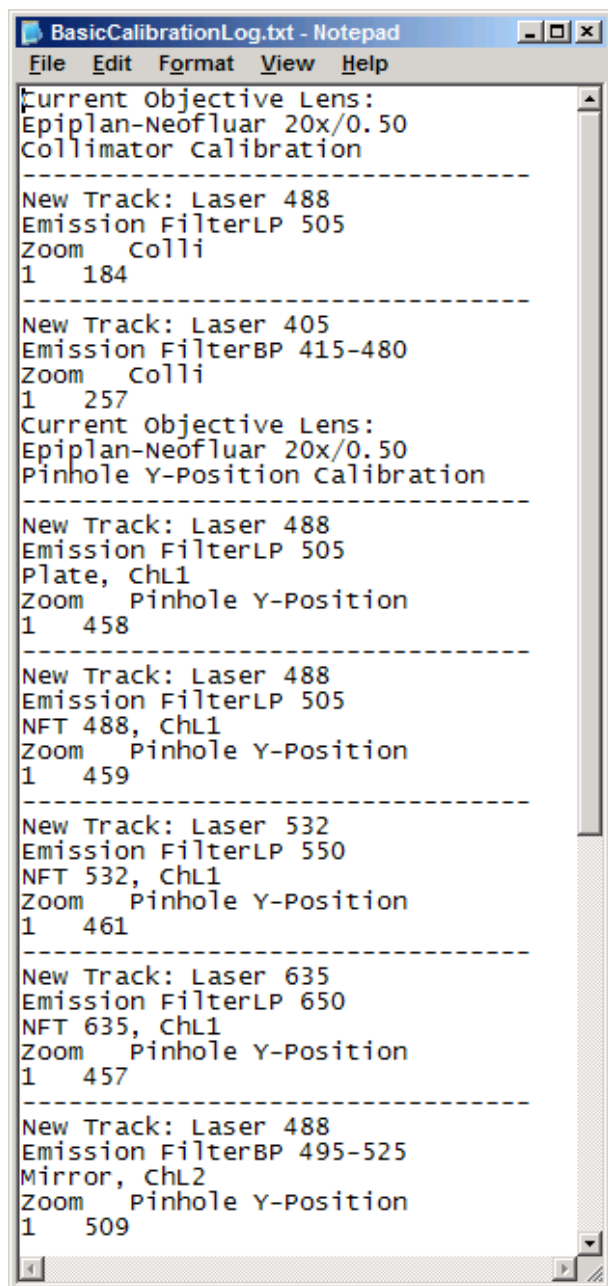



Fig. 18 Calibration file



```
BasicCalibrationLog.txt - Notepad
File Edit Format View Help
Current Objective Lens:
Epiplan-Neofluar 20x/0.50
Collimator Calibration
-----
New Track: Laser 488
Emission FilterLP 505
Zoom Colli
1 184
-----
New Track: Laser 405
Emission FilterBP 415-480
Zoom Colli
1 257
Current Objective Lens:
Epiplan-Neofluar 20x/0.50
Pinhole Y-Position Calibration
-----
New Track: Laser 488
Emission FilterLP 505
Plate, ChL1
Zoom Pinhole Y-Position
1 458
-----
New Track: Laser 488
Emission FilterLP 505
NFT 488, ChL1
Zoom Pinhole Y-Position
1 459
-----
New Track: Laser 532
Emission FilterLP 550
NFT 532, ChL1
Zoom Pinhole Y-Position
1 461
-----
New Track: Laser 635
Emission FilterLP 650
NFT 635, ChL1
Zoom Pinhole Y-Position
1 457
-----
New Track: Laser 488
Emission FilterBP 495-525
Mirror, ChL2
Zoom Pinhole Y-Position
1 509
```

Fig. 19 BasicCalibrationLog file

The calibration results of the Basic Calibration will be saved in a file named **BasicCalibrationLog.txt** (to be found in the BIN-Folder as well).

 Changes won't effect the stored values.

5.1.6 OptimizeLIVE Macro

For temporary optimization of the LSM 7 *LIVE* beampath, try to avoid a modification of the general adjustment in the pinhole dialogue. Use the **Optimize** slider instead. The general setting of the confocal aperture might still be correct for other scan parameters.

The Optimize slider can be set independently for each channel. The slider is moved to the one or the other side while scanning continuous. The brightest image result is the optimal setting. This setting does not affect the general adjustment of the LSM 7 *LIVE* collimator and confocal aperture, but can enhance image brightness efficiently.

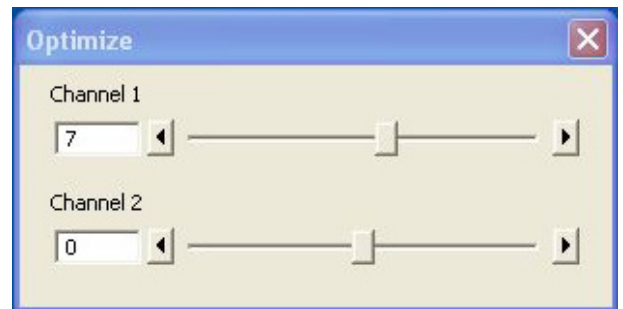


Fig. 20 Optimize window

5.1.7 Image Match (Scanfield Transformation) Macro

Adjusts the Image match between two scanning imaging systems or a manipulation and a scanning imaging system.

To adjust the image match, set up a multitracking that creates one channel for each scanning and/or manipulation system. In case of the LSM *DuoScan* in combination with LSM 7 *LIVE*, use a T-PMT to create an image with the *DuoScan* system.

For LSM 7 *MP* with two scanning systems, chose the right beam combiner in the reflector turret when adjusting the scanfields with the macro. It has to be confirmed, that both laser beams are optimally aligned to the optical axis of each scanner respectively before adjusting the scanfields. The alignment of the laser beams to the optical axis is performed by the field service engineer at the set up of the system.

- Start the Image Match (Scanfield Transformation) Macro (Fig. 21).
- Use the Image match calibration sample delivered with the system. This sample has a fluorescent layer and a reflective grid, useful to create images in fluorescent, reflective or transmission light mode.
- Start continuous scan, and set laser power and gain to appropriate levels. The point scanning system will be the speed limiting system, so choose a fast scanning speed to get a faster image refresh.
- Use unidirectional scan to avoid adjustment errors due to bidirectional image jitters.
- For LSM 7 *LIVE* with LSM *DuoScan* set the matching zoom factors with one of the **Match DuoScan zoom/offset** or **Match LIVE zoom/offset** buttons relative to each other. It is recommended to adjust the LSM zoom.

These buttons set the two scanheads at a matching scanfield diameter.

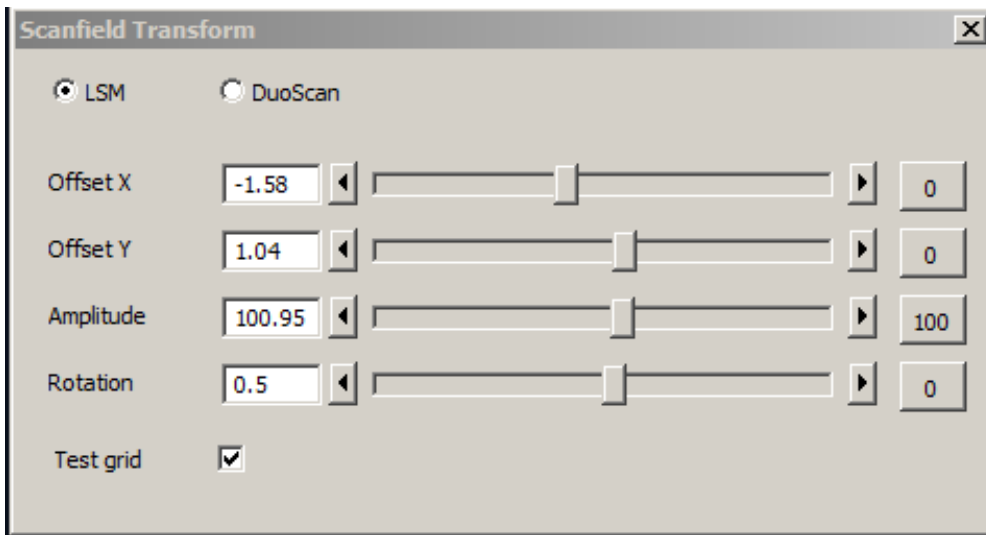


Fig. 21 Scanfield Transform macro interface

- Choose split image for the image window display. You will see the scanned areas of both scanning systems and an overlay.

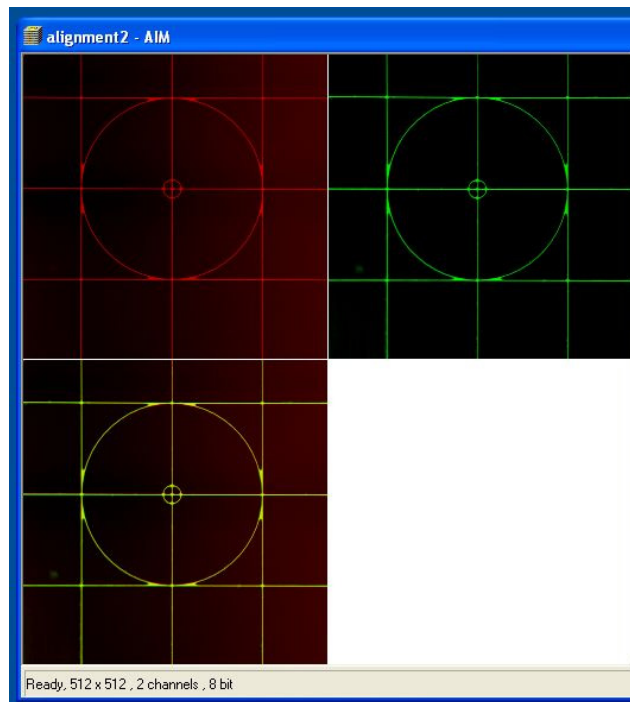



Fig. 22 Split image

- Choose LSM (710) or *DuoScan* to adjust the image match.
- While scanning, move the sliders of the Image match macro to get a perfect overlay of the scanning and/or manipulation system relative to each other.
- Offset X/Y adjusts the horizontal and vertical image shift
- Amplitude adjusts a size difference between the images
- Rotation compensates for a tilt in one of the images.

 Store the final image, and use the ReUse function for future image matching. The Multitrack setup and the Zoom factors will then be set automatically.


- For LSM 7 *MP* with two scanners, focus onto the grid using the imaging scanner (chose "LSM" in the Macro window) and position the center of the grid sample into the center of the image. To do this project the virtual grid into the image by checking the box next to **Test grid** in the macro window (Fig. 21) and try to overlay the grid sample with the Test grid in the image moving the sample stage accordingly. Fine adjust the image of the grid sample to the Test grid using the buttons for Offset, Amplitude and Rotation.
- Next switch to "DuoScan" and adjust the image of the grid sample to the Test grid using Offset, Amplitude and Rotation. Do not move the sample grid during this step. Take care to use moderate laser powers of only a few % as the Multiphotonlaser can destroy the grid sample.

5.1.8 Visual Macro Editor

The Visual Macro Editor is an optional software module which allows the user to program a variety of scanning procedures, image calculations or image processing routines as well as the combination of these functions.

5.1.8.1 Open / Close the Visual Macro Editor Window

- Choose the **Visual Macro Editor** from the **Macro** menu in the Main Menu Bar.

- Click on the  button in the upper right side of the window to quit.

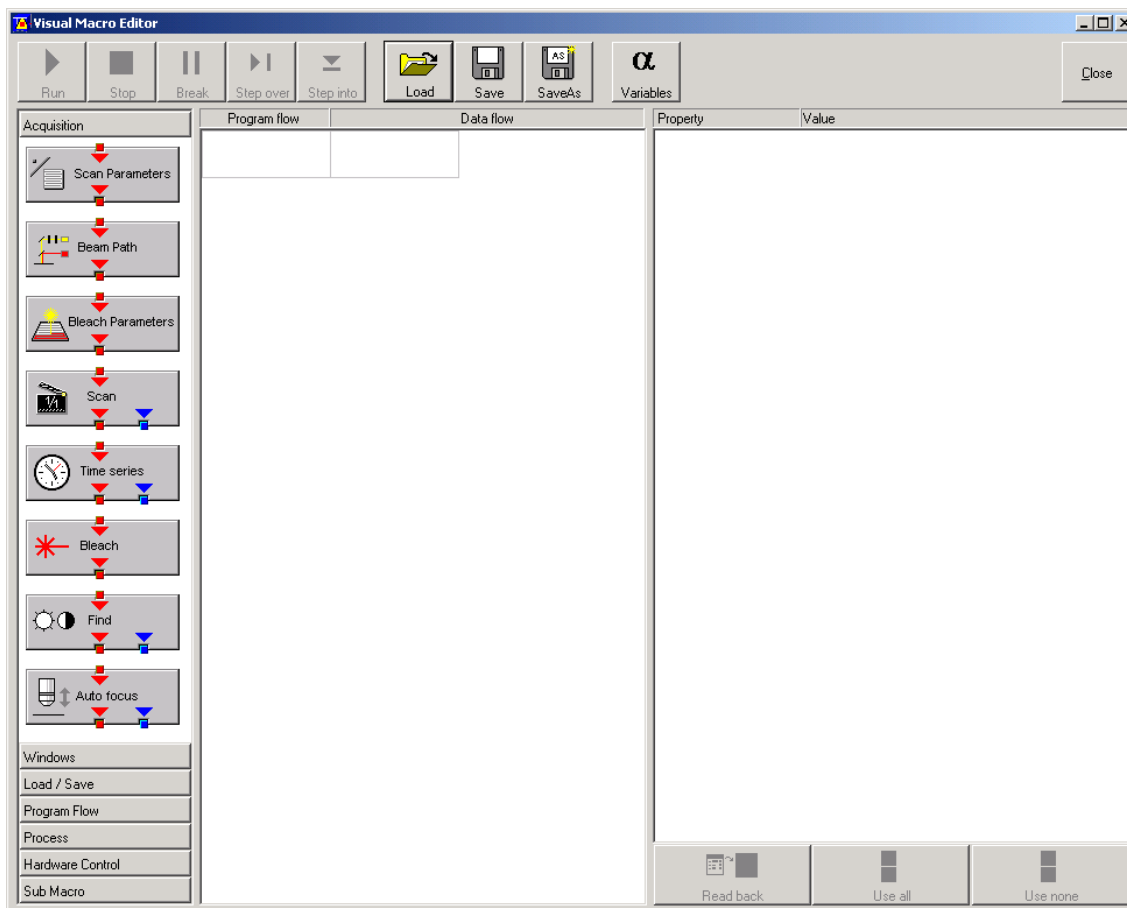


Fig. 23 Visual Macro Editor window

5.1.8.2 Function Description




Toolbar buttons

Run	Starts the macro starting with the first block in the program flow column.
Stop	Stops the macro at any time.
Break	Interrupts the macro. Clicking the button again will resume the actual program flow of the Macro.
Step over	Runs a sub-macro and stops at the first action block in the main macro.
Step into	Stops at the first action block in a sub-macro.
Load / Save / Save as	Use Load to open an existing macro and Save to store the macro. SaveAs allows storing the same macro under a different name.
Variables	By clicking the button the list of defined variables is displayed. New ones can be added by typing in name and value in the next free line. Variables are assigned to macros. For each new macro a new list of variables has to be generated.

The editor uses predefined action blocks. The action blocks for setting up the work flow of the macro are categorized according to their properties. The following categories are displayed on the left-hand side of the **Visual Macro Editor** control window.

- Acquisition
 - Windows
 - Load/Save
 - Program Flow
 - Process
 - Hardware Control
 - Sub Macro
- Click on one of the category selection buttons will display the available action blocks.

The action blocks can be positioned according to their function either in the **Program Flow** column or the **Data Flow** column. The color of the connection arrows of the action block defines the possibility to position the block in the program flow column or the data flow column(s).
 - Click at the action block with the left mouse button (hold down the mouse button) and drag the mouse cursor into the flow column. Release the mouse button.
 - Action blocks for the program flow show red connection arrows ▼ as well as blue output arrows ▼ to connect to the data flow.
 - Action blocks for the data flow show blue connection arrows ▼ or green output arrows ▼ to connect back to the program flow.

-
-  It is not possible to drag an action block for program flow into the data flow or an action block for data flow into the program flow.
Action blocks can be removed using the **Delete** key of the keyboard.
 -  A block is highlighted by clicking onto the block icon. To highlight more than one block drag the cursor over the block icons to be marked. A click on the right mouse button also allows the use of the functions **cut**, **copy**, **paste**, and **delete** to modify a macro.
 -  Without using the **Image Display** action block in the data flow column, the result of the scan will not be displayed (see also description of **Scan** and **Time Series** action blocks).

The work flow is generated by connecting the action blocks using the mouse cursor.

- Click onto an output arrow with the left mouse button (hold down the mouse button) and drag the mouse cursor away.
 - A connecting line appears.
- Drag the line to the input arrow of another action block. Only arrows of the same color can be connected.

According to the action blocks a set of properties is listed which can be assigned with free or predefined values. These values can also be variables. A set of defined properties is assigned to one block only. If this block is used more than once the properties can be set differently.

Clicking the **Read Back** button will take over the current settings from the LSM main program for the displayed properties list.

- Mark the check boxes next to the parameters individually or, click **Use all** or **Use none** to check or uncheck all parameters with one click.
- For changing value click into the **Value** column.

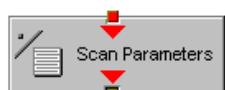
It is possible to define variables. A variable has a (property) name and a mathematical value. The **Assignment** action block can be used to assign a new value to a variable when inserted into the program flow using mathematical algorithms. The new value is then used for any subsequent calculation in the program flow where the variable is part of the calculation.

- Click the **Variable** button on the toolbar to display the variable list. Click once more to display the parameter list again.
- New variables can be added by typing in name and value in the next free line.

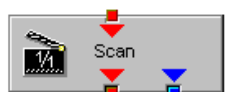
Acquisition Action Blocks



Loads a Beam Path Configuration from the Configuration list or uses the current one that is set up in the main program. Use the pull down menu in the **Property/Value** list to select the Configuration that should be used for imaging. Changing between Single Track and Multi Track allows to choose between the different Configuration lists. Multi Track also lists tracks that are used for Emission Fingerprinting or Online Fingerprinting. Depending on the type of track different settings can be loaded optionally. If they are not loaded and the parameters list of the Scan Parameter block does not offer them as being editable, for example detector gain and offset, default values will be used. Read back will use the actual parameters of the main program.



The list of properties lists all parameters that can be adjusted for the scan procedure. The value for each parameter can be typed in individually. Clicking the **Read Back** button will take over all current settings from the main software. The check boxes next to the parameters can be marked individually or, clicking **Use all** or **Use none** they can be all checked or unchecked with one click. Only the parameters with a mark in the check box will be taken into account and adjusted when the Scan Parameter block is set in the program flow column. This allows to change only some of the parameters, for example the zoom, at a certain position within the program flow as for each block the check boxes can be set.



This block performs the scanning of the sample according to the settings chosen with Beam Path and Scan Parameters. It can be linked to the Data flow column. If no connection to the data flow is made (for example: Display Image) the result of the scan will not be displayed.



The parameters for bleaching the sample can be loaded from the list of bleach settings. Bleach settings are assembled and stored in the Bleach control window of the main software.



This block performs the bleaching of the sample according to the bleach settings that have been defined in the Bleach Parameters block.



The list of properties lists all parameters that can be adjusted for the acquisition of the time series. The value for each parameter can be typed in individually. Clicking the **Read Back** button will take over all current settings from the main software. The check boxes next to the parameters can be marked individually or, clicking **Use all** or **Use none** they can be all checked or unchecked with one click. Only the parameters with a mark in the check box will be taken into account and adjusted when the Time series block is used in the program flow column. This allows to change only some of the parameters at a certain position within the program flow, for example the trigger used, as for each Time series action block the check boxes can be set individually. Activating the Bleach parameter will bleach the sample according to the settings in the Bleach Parameters action block during the time series. The Time series action block can be connected to the data flow column.



This block performs the **Find** function according to the main software.



This action block sets the Z-position according to the focusing procedure set with the parameters available. The image generated displays the image or image series acquired to set the focus position. The following properties are available to define the auto focus function:

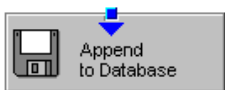
- Mode/Precise: Uses fast XYZ-scan(s); the scan parameters can be defined via Scan Parameters Action Block
- Mode/Fast: Uses fast XZ-scan(s)
- Method/Intensity: auto focus mode which searches for maximum intensity.
- Method/Contrast: auto focus mode which searches for maximum contrast.
- Range (μm): The system will perform the auto focus search within that range.
- Offset (μm): Defines the distance between the focus plane set by the auto focus function (e.g. coverslip reflex) and the focal plane for imaging.
- Assign position to: Chose a variable to which the new position of the focus plane set by the auto focus function (e.g. coverslip reflex) should be assigned.
- Assign offset to: Chose a variable to which the offset value should be assigned.

Windows Action Blocks



This block has to be used if the actually scanned image(s) should be displayed. For each Image Display block a new image window is opened. If not saved, the image will be overwritten when the program flow is passing by again.

Load / Save / Action Blocks



The image(s) are stored to an image database. The database taken is either the last one, that was open or the current open one. Clicking Read back updates the database to be used for storing the image(s). In addition some other parameters can be set according to the list of properties displayed.



Within the program flow already existing images can be loaded.

The database taken is either the last one, that was open or the current open one. Clicking Read back updates the database to be used to load the image(s) from. The images can be loaded by Index or by the name of the image.

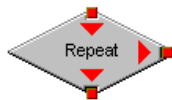


It is possible to export images choosing a certain file format from the pull down list that appears when highlighting the line File Format in the properties list. Specific parameters are assigned to each file format which can be set for the image export.

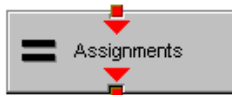


Images can be imported within the program flow. The image to be loaded can be selected by typing in the file path. The import of single images or an image series is possible. The images to be imported as series must have the same name and must be numbered in ascending order.

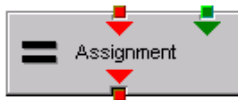
Program Flow Action Blocks



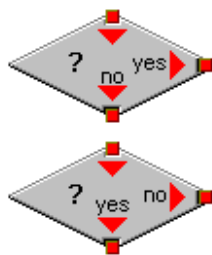
If any action(s) should be repeated a defined number of times, the Repeat block should be set into the loop of the program flow. The number of repeats is set in the properties list. The repeat is only performed using the connection of the right arrow. After finishing the repeats, the program flow connected to the arrow pointing down is performed.



Using this block in the program flow allows to assign new values to a selected variable using mathematical calculations which can be typed into the value line. All predefined variables can also be used for calculations. By passing this block the variable will be transiently changed and the new value can for example be used to assign different numbers to the image name or to increase the time delay during a time series acquisition.



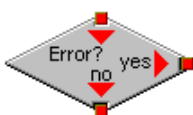
This block assigns a new value to a variable which has to be selected from the drop down list. The value assigned results from a calculation taken from the statistics action block (see below).



The two blocks are used as decision makers. Depending on the value of a predefined variable, the program flow can be directed to one of the two possible directions. The expression of the variable's value which should be used to decide on the program flow is set in the properties list individually for each used decision making block. It takes the actual transient value of the variable into account.

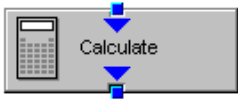


This block introduces a delay in the program flow. The delay time is started when the block is reached within the program flow.

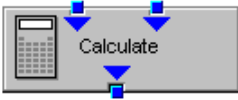


The block allows to assign a potential error message with a textbox and to decide on the Error where to direct the program flow. If no textbox is assigned the program flow will just continue according to the presence of an error message. Choosing a textbox requires the input of the user to continue with the program flow.

Process Action Blocks



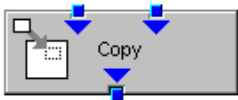
This block allows to do image calculation using the pixel intensities of the image. The operators for the formulas that can be used are described in the Ratio Dialogue within the Process Menu. The formulas set up in the Image calculation window can be copied and pasted into the properties list of the Visual Macro Editor.



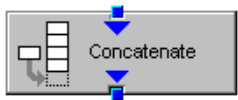
For calculations using two different sources the Calculate block with two possible inputs is used. The calculation starts when both inputs have arrived. Within program loops the next calculation will start when the inputs have arrived again in the same sequence as the first time. The operators for the formulas that can be used are described in the Ratio Dialogue within the Process Menu. The formulas set up in the Image calculation window can be copied and pasted into the properties list of the Visual Macro Editor.



The input image will be copied to a new image format that can be defined by changing the values of the listed properties.



Using this block enables to copy one image into another with the coordinates and settings put into the properties list. The destination image is connected to the left input; the source image is connected to the right input.



The subsequently arriving images will be concatenated according to the coordinate setting and treated as one image. A subsequent image display will be updated each time a new image arrives.



The second concatenate action block allows to concatenate images from two different acquisition blocks.



The block uses an input image (left input) and chooses a region within that image according to a mask (right input) that has been defined in the Mask action block (see below). Within that mask region of a selected channel, one of the following result values can be selected which is then assigned to the chosen variable in the corresponding assignment action block:

- Mean intensity: Equals mean intensity within mask region
- Standard deviation: Equals standard deviation of intensity distribution within mask region
- Number Pixels: Number of pixels that constitute the mask region
- Area ($\mu\text{m} \times \mu\text{m}$): Area of mask region
- Minimum: Minimum intensity value found within mask region
- Maximum: Maximum intensity value found within mask region



This action block defines a mask (image region with defined properties) derived from an image window. The image can be a newly acquired or imported image. The properties of the mask based on the image data can be selected according to the following properties:

- Scan region(s): The mask is based on the scan region(s) defined in the **ScanControl**.
- Bleach region(s): The mask is based on bleached region(s) defined in the **BleachControl**.
- Image overlay: The mask is based on image overlay regions.
- ROI list entry: The mask is based on ROIs listed in Edit ROI control window.
- Interactive overlay: The mask is defined using overlay regions which are defined while the macro is executed.
- Interactive histogram: The mask is defined via histogram settings (min/max) interactively defined while the macro is executed. This works in conjunction with ROI selection (interactive or stored) as described above.
- Region index: Index of ROI (i.e. ROI number) if for example multiple bleach regions are active.
- Channel: Image channel which is used to derive the mask parameters from. This works in conjunction with interactive settings or loaded images.
- Intensity range: Defines the intensity range which is applied for mask definition.
- Lower threshold: Defines lower intensity threshold which is applied for mask definition. This threshold can be an absolute number or a floating point.
- Upper threshold: Defines upper intensity threshold which is applied for mask definition. This threshold can be an absolute number or a floating point.

Hardware Control Action Blocks



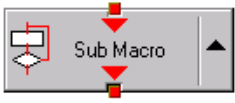
If a motorized stage is available the movement of the stage can be set up as part of the program flow. The stage can be moved to an absolute position which can also be taken from the actual stage position using the Read back function or typed in individually. Using a relative position will use the current stage position as relating position. The values have to be typed in.


It is also possible to choose the position from the **Mark and Find** position list which must have been set up in the stage control menu to be available.



The movement of the focus can be set up as part of the program flow. The focus can be moved to an absolute position which can also be taken from the actual focus position using the Read back function or typed in individually. Using a relative position will use the current focus position as relating position. The values have to be typed in. For large travel ranges which exceed half of the objectives working distance a warning can be displayed.

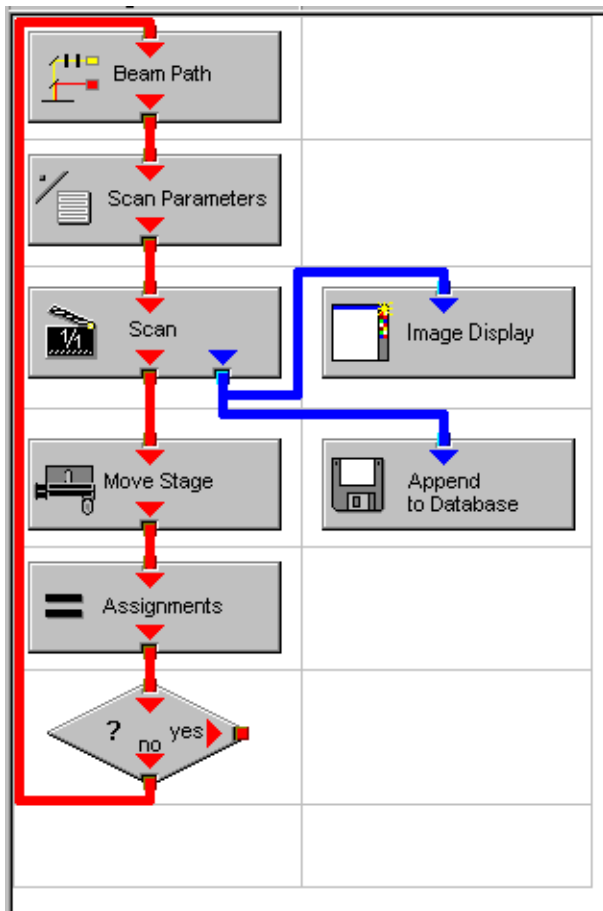
Sub Macro Actions Blocks



This block allows to set a sub macro within a main macro. The sup macro is opened by clicking onto the arrow in the block icon and closed clicking the  top right of the program flow column. The number of program flow in- and outputs as well as the number of program flow in- and outputs (= number of available connection arrows indicated on the block icon) can be defined for each sub macro. Multiple connections are therefore possible. The maximum of inputs and outputs for each flow is ten.



Using this block allows to integrate macros or macro procedures programmed with visual basic into a VME macro. The number of data flow inputs and outputs can be set to a maximum number of ten. The name of the macro indicates the name within the VME macro. The file name refers to the path and name of the VBA macro to be loaded into the VME macro. If no procedure available within the VBA macro is selected the whole VBA macro will be executed.



5.1.8.3 Editing a Macro

Following Example shows a macro which acquires five subsequent images and moves the stage 10 microns in X and Y following each image. The images are stored and numbered in ascending order.

- Arrange and connect the action blocks (Fig. 24).

Fig. 24 Arrangement of action blocks

- Assign the value 1 to a variable named Index (Fig. 25).

Property	Value
Index	1

Fig. 25 Assignment of the variable

- Click the single action blocks and assign the values to the listed properties (beam path and scan parameters can be chosen according to the sample).

Property	Value
Configuration Type	Single Track
Configuration	488 FITC
Load Speed	No
Load Bits per Sample	No
Load Pinhole Diameter	No
Load Gain and Offset	No

Fig. 26 Property list of the Beam Path action block

Use	Property	Value
<input checked="" type="checkbox"/>	LSM Pixels X	512
<input checked="" type="checkbox"/>	LSM Pixels Y	512
<input checked="" type="checkbox"/>	LSM Step Y	1
<input checked="" type="checkbox"/>	LSM Zoom	1.600000
<input checked="" type="checkbox"/>	LSM Rotation [°]	45.000000
<input checked="" type="checkbox"/>	LSM Offset X [µm]	0.000000
<input checked="" type="checkbox"/>	LSM Offset Y [µm]	0.000000
<input checked="" type="checkbox"/>	LSM Pixel Period [µs]	2.560000
<input checked="" type="checkbox"/>	Camera Mode	Mono 1300 x 1030
<input checked="" type="checkbox"/>	Camera Pixels X	1300
<input checked="" type="checkbox"/>	Camera Pixels Y	1030
<input checked="" type="checkbox"/>	Camera Offset X [Pixels]	0.000000
<input checked="" type="checkbox"/>	Camera Offset Y [Pixels]	0.000000
<input checked="" type="checkbox"/>	Pixels Z	1
<input checked="" type="checkbox"/>	Scaling Z [µm]	1.000000
<input checked="" type="checkbox"/>	Offset Z [µm]	0.000000
<input checked="" type="checkbox"/>	Bits per Sample	8 bit

Fig. 27 Property list of the Scan Parameter action block

- The database the images will be appended to is automatically displayed when highlighting the **Append to Database** action block. The last one used will be taken. To update this, open the desired database and use the **Read back** function. Type in a name for the images with or without quotation marks. All images will get the same name then. For numbering the images use quotation marks for the name and add the variable Index, which has been assigned with the value 1. This value or the transiently changed value of the variable will be added to the name of the image.

Property	Value
Database	D:\Projekte\Release 3.5 RT\SW\Scripting\test 2.mdb
Name	"Cell culture" + Index
Description	
Notes	
Compress	Yes

Fig. 28 Property list of the Append to Database action block

Property	Value
Mode	Relative Position
Distance X [μm]	10
Distance Y [μm]	10

Fig. 29 Property list of the Move stage action block.

Property	Value
Index	Index + 1

Fig. 30 Property list of the Assignments action block

Property	Value
Expression	Index > 5

Fig. 31 Property list of the Decision action block

- The movement of the stage is defined highlighting the Move stage action block, choosing the Mode Relative Position in the Property list and typing in the value 10 for X and Y which then will move the stage 10 microns into X and Y direction starting with the current stage position on passing that action block.
- Now the first complete scan has been performed and the image is stored. For the next cycle the variable Index has to get another value to make sure the numbering of the images works. Using the **Assignments** action block, the Variable Index is chosen and the value assigned is **Index + 1**. Such the variable will get the transient value 2 for the next cycle, the value 3 for the over next cycle and so on.
- The number of repeats can be defined using a Decision block and using the value of the variable as base for the decision. By defining that if the Expression of the variable is larger than 5 and not connecting the output arrow marked with 'yes' to any other block, the macro will stop after the acquisition of five images. Alternatively one can use at this part of the program flow the Repeat block and define the number of repeats to be performed, which would be 5 in this case (The first scan is already counted!)

5.2 VBA PROGRAMMING FOR LSM

5.2.1 VBA Programming

5.2.1.1 General Syntax

Object oriented programming

Class Modules

5.2.1.2 Working with Files

I/O operations, file operations are implemented in VBA

Use of the implemented functions

Example:

```
Type CALIBRATION_PARAM
  lambda As Long
  angle As Double
  Translation As Double
End Type
```

```
Function DataFromCalibFile(strGetFile As String, calibArray() As CALIBRATION_PARAM) As Integer
  Dim hFile As Long
  Dim strLine As String
  Dim varData(1 To 3) As Variant
  Dim paramCnt As Integer

  paramCnt = -1
  'get the next free file handle
  hFile = FreeFile
  'check if file exist
  If (Len(Dir(strGetFile)) > 0) Then
    Open strGetFile For Input Access Read Shared As hFile
    If (Not EOF(hFile)) Then
      Line Input #hFile, strLine

      paramCnt = 0
      Do Until EOF(hFile)
        Input #hFile, varData(1), varData(2), varData(3)
        calibArray(paramCnt).lambda = varData(1)
        calibArray(paramCnt).angle = varData(2)
        calibArray(paramCnt).Translation = varData(3)
        paramCnt = paramCnt + 1
      Loop
    End If
    Close #hFile
  End If

  DataFromCalibFile = paramCnt
End Function Objektstruktur
```

Use of the API function for additional functionality

5.2.1.3 Access to Windows API Function and external DLLs

- with Type Libraries

OLE

- with Declare Statements

API Text Viewer

searches WIN32API.TXT

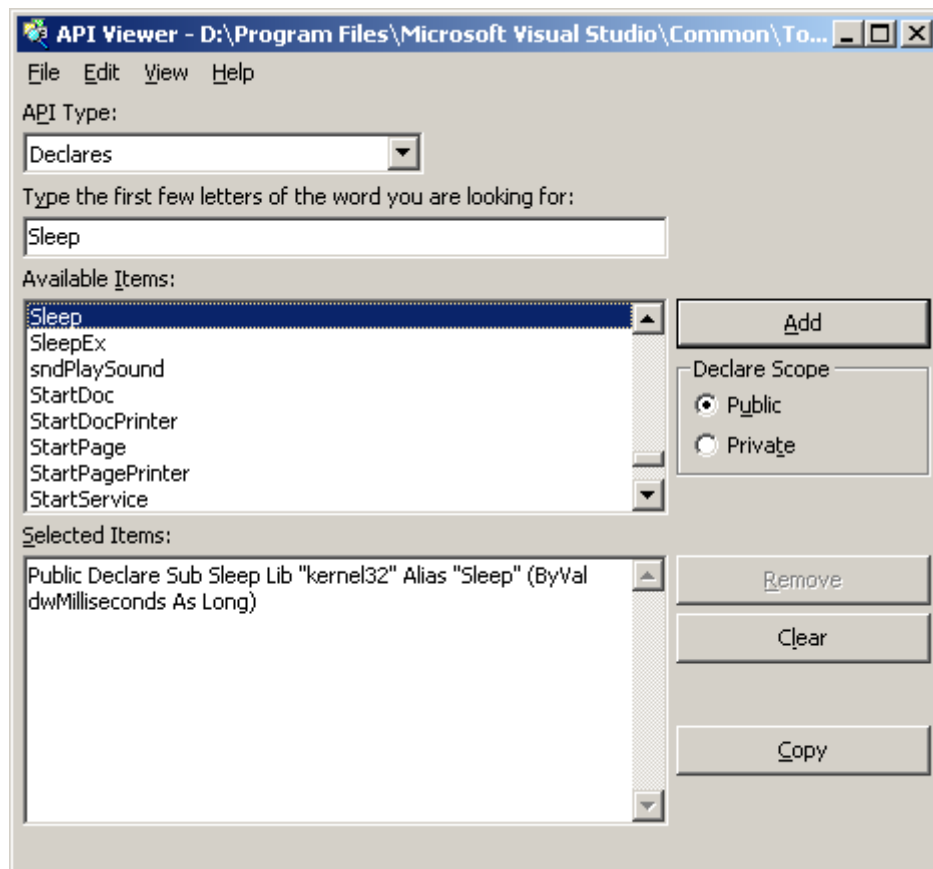


Fig. 32 API Viewer window

Example:

```
Declare Sub Sleep Lib "kernel32" (ByVal dwMilliseconds As Long)
```

```
Declare Function RegOpenKeyEx _  
    Lib "advapi32.dll" Alias "RegOpenKeyExA" _  
    (ByVal hKey As Long, ByVal lpSubKey As String, _  
    ByVal ulOptions As Long, ByVal samDesired As Long, _  
    phkResult As Long) As Long
```

```
Public Declare Function RegCloseKey _  
    Lib "advapi32.dll" (ByVal hKey As Long) As Long
```

```
Public Declare Function RegQueryValueEx _  
    Lib "advapi32.dll" Alias "RegQueryValueExA" _  
    (ByVal hKey As Long, ByVal lpValueName As String, _  
    ByVal lpReserved As Long, lpType As Long, _  
    lpData As Any, lpcbData As Long) As Long ' Note that if you declare the lpData parameter  
    as String, you must pass it By Value.
```

```
Public Const HKEY_CLASSES_ROOT = &H80000000
```

```
Public Const SYNCHRONIZE = &H100000
```

```
Public Const READ_CONTROL = &H20000
```

```
Public Const STANDARD_RIGHTS_READ = (READ_CONTROL)
```

```
Public Const KEY_QUERY_VALUE = &H1
```

```
Public Const KEY_ENUMERATE_SUB_KEYS = &H8
```

```
Public Const KEY_NOTIFY = &H10
```

```
Public Const KEY_READ = ((STANDARD_RIGHTS_READ Or KEY_QUERY_VALUE Or  
KEY_ENUMERATE_SUB_KEYS Or KEY_NOTIFY) And (Not SYNCHRONIZE))
```

```
Public Const REG_SZ = 1 ' Unicode null terminated string
```

```
Public Const ERROR_SUCCESS = 0&
```

```

Function FServerFromDescription(strName As String, strPath As String) As Boolean
    Dim lngResult As Long
    Dim strTmp As String
    Dim hKeyServer As Long
    Dim strBuffer As String
    Dim cb As Long
    Dim i As Integer

    FServerFromDescription = False

    strTmp = VBA.Space(255)
    strTmp = strName + "\CLSID"
    lngResult = RegOpenKeyEx(HKEY_CLASSES_ROOT, strTmp, 0&, KEY_READ, hKeyServer)

    If (Not lngResult = ERROR_SUCCESS) Then GoTo error_exit
    strBuffer = VBA.Space(255)
    cb = Len(strBuffer)

    lngResult = RegQueryValueEx(hKeyServer, "", 0&, REG_SZ, ByVal strBuffer, cb)
    If (Not lngResult = ERROR_SUCCESS) Then GoTo error_exit

    lngResult = RegCloseKey(hKeyServer)
    strTmp = VBA.Space(255)
    strTmp = "CLSID\" + Left(strBuffer, cb - 1) + "\LocalServer32"
    strBuffer = VBA.Space(255)
    cb = Len(strBuffer)
    lngResult = RegOpenKeyEx(HKEY_CLASSES_ROOT, strTmp, 0&, KEY_READ, hKeyServer)
    If (Not lngResult = ERROR_SUCCESS) Then GoTo error_exit

    lngResult = RegQueryValueEx(hKeyServer, "", 0&, REG_SZ, ByVal strBuffer, cb)
    If (Not lngResult = ERROR_SUCCESS) Then GoTo error_exit
    strPath = Left(strBuffer, cb - 1)

```

IngResult = RegCloseKey(hKeyServer)

hKeyServer = 0

i = Len(strPath)

Do Until (i = 0)

If (VBA.Mid(strPath, i, 1) = "\") Then

strPath = Left(strPath, i - 1)

FServerFromDescription = True

Exit Do

End If

i = i - 1

Loop

error_exit:

If (Not hKeyServer = 0) Then IngResult = RegCloseKey(hKeyServer)

hKeyServer = 0

End Function

5.2.2 Programming for LSM

5.2.2.1 Object structure

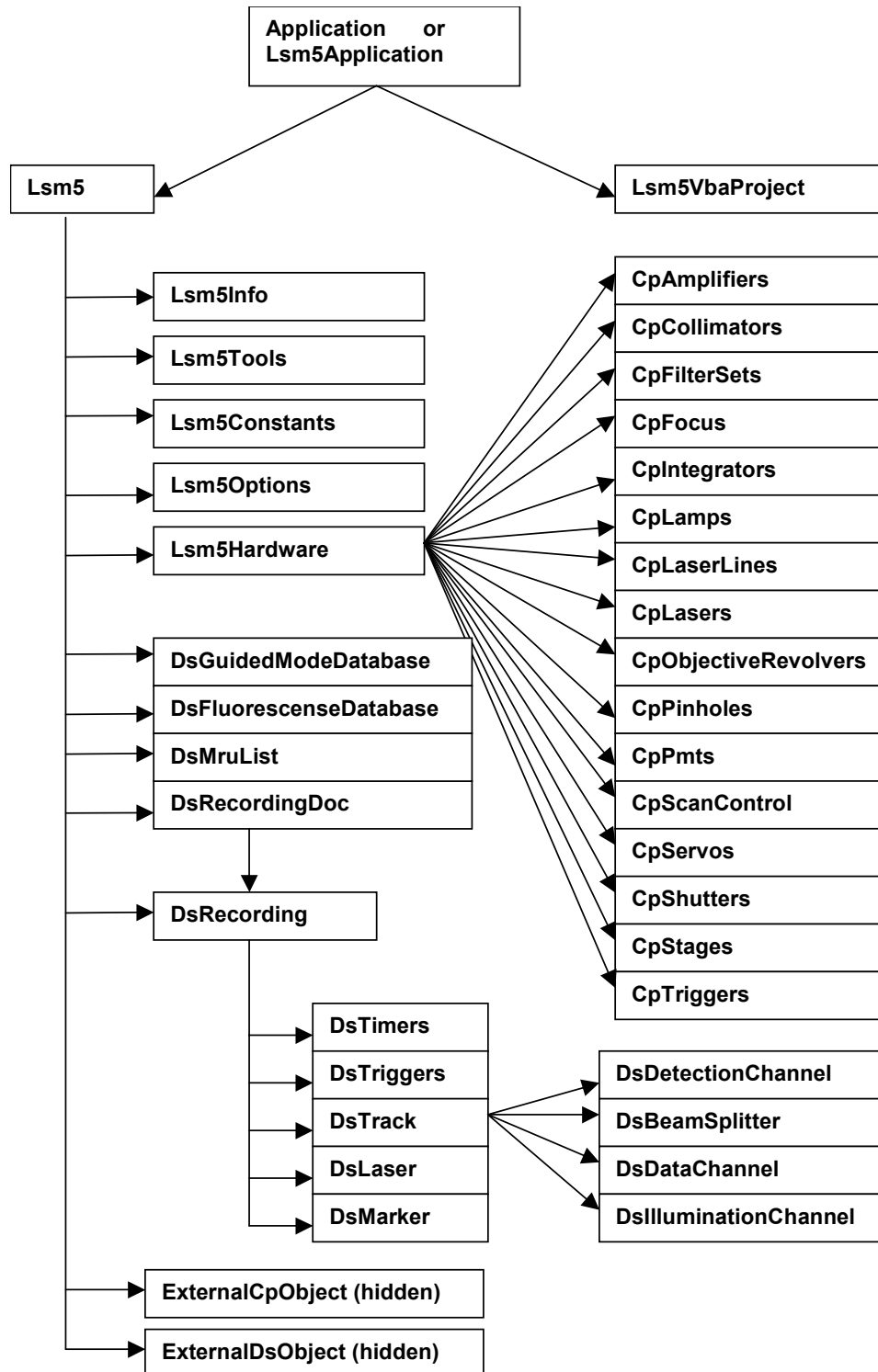


Fig. 33 Object structure

To search the object structure, use the object browser.

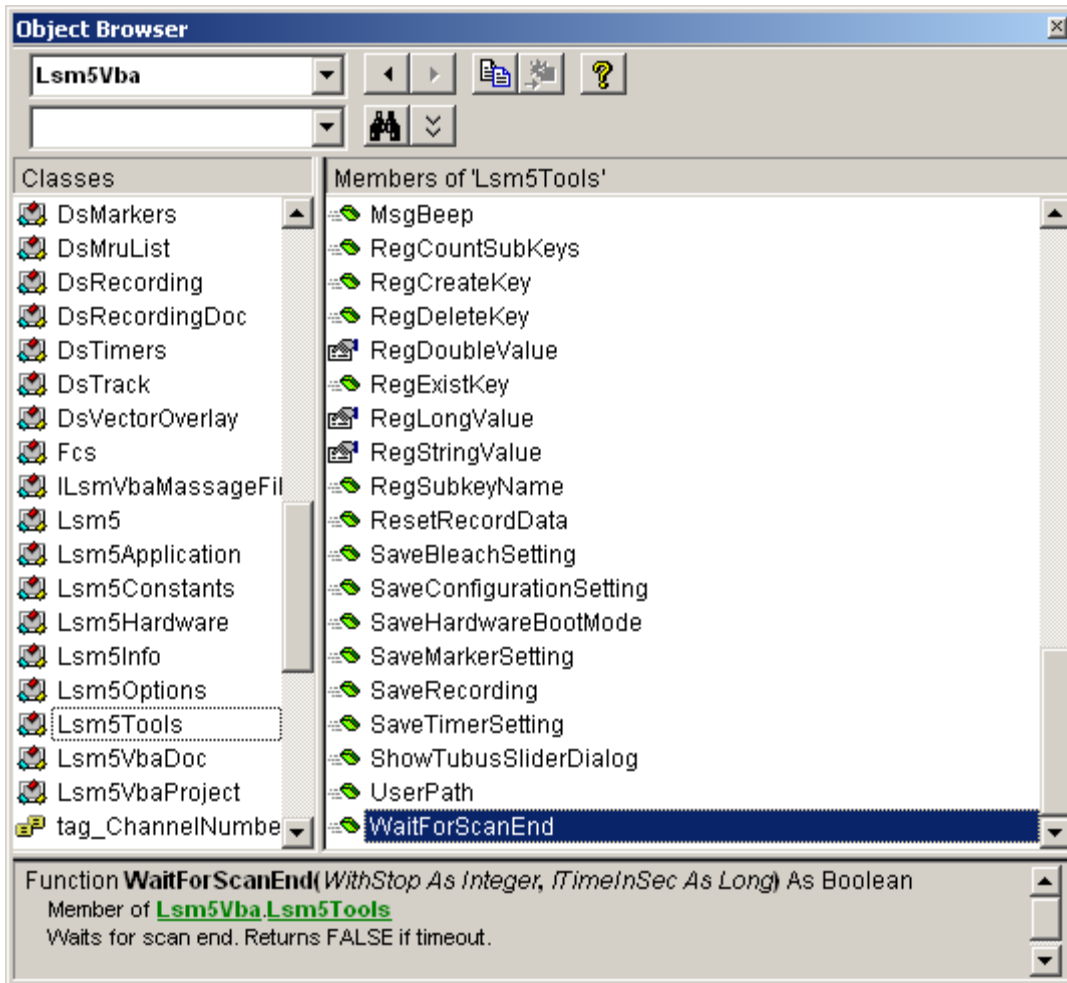


Fig. 34 Object Browser window

5.2.2.2 Differences in access to LSM Hardware with LSM 7 Hardware Object / DsRecording Object

Object Browser Project / Library LsmVba auswählen und Objekt Struktur untersuchen

- Access with DsRecording Object

Status maintains at Scan Start

```

Public Sub CopyRecording(Destination As DsRecording, Source As DsRecording)
    Dim TS As DsTrack
    Dim TD As DsTrack
    Dim DataS As DsDataChannel
    Dim DataD As DsDataChannel
    Dim DetS As DsDetectionChannel
    Dim DetD As DsDetectionChannel
    Dim IIS As DsIlluminationChannel
    Dim IID As DsIlluminationChannel
    Dim BS As DsBeamSplitter
    Dim BD As DsBeamSplitter
    Dim IT As Long
    Dim II As Long
    Dim success As Integer

    Destination.Copy Source
    Destination.Objective = Source.Objective
    For IT = 0 To Destination.TrackCount - 1

        Set TS = Source.TrackObjectByIndex(IT, success)
        Set TD = Destination.TrackObjectByIndex(IT, success)

        TD.Collimator1Position = TS.Collimator1Position
        TD.Collimator2Position = TS.Collimator2Position

        For II = 0 To TD.DataChannelCount - 1
            Set DataS = TS.DataChannelObjectByIndex(II, success)
            Set DataD = TD.DataChannelObjectByIndex(II, success)
            DataD.ColorRef = DataS.ColorRef
        Next II
    
```

```
For II = 0 To TD.DetectionChannelCount - 1
    Set DetS = TS.DetectionChannelObjectByIndex(II, success)
    Set DetD = TD.DetectionChannelObjectByIndex(II, success)
    DetD.Filter1 = DetS.Filter1
    DetD.Filter2 = DetS.Filter2
    DetD.DetectorGain = DetS.DetectorGain
    DetD.AmplifierGain = DetS.AmplifierGain
    DetD.AmplifierOffset = DetS.AmplifierOffset
    DetD.PinholeDiameter = DetS.PinholeDiameter
Next II
```

```
For II = 0 To TD.IlluminationChannelCount - 1
    Set IIS = TS.IlluminationObjectByIndex(II, success)
    Set IID = TD.IlluminationObjectByIndex(II, success)
    IID.Acquire = IIS.Acquire
    ID.Power = IIS.Power
    IID.DetectionChannelName = IIS.DetectionChannelName
Next II
```

```
For II = 0 To TD.BeamSplitterCount - 1
    Set BS = TS.BeamSplitterObjectByIndex(II, success)
    Set BD = TD.BeamSplitterObjectByIndex(II, success)
    BD.Filter = BS.Filter
Next II
```

```
Next IT
End Sub
```

- Access with Lsm5Hardware Object

Status will be updated at Scan Start to current recording parameters

```

Private Sub FillPinholeList()
    Dim count As Long
    Dim i As Long
    Dim ObjPinholes As CpPinholes
    Dim Servos As Object
    Dim ServoX As Object
    Dim ServoY As Object
    Dim success As Boolean

    CmbPinhole.Clear

    Set Servos = Lsm5.ExternalCpObject.pHardwareObjects.pServos
    Set ObjPinholes = Lsm5.Hardware.CpPinholes
    count = ObjPinholes.count
    For i = 0 To count - 1
        success = ObjPinholes.Select(i)
        If (success) Then
            Set ServoX = Servos.pltem(ObjPinholes.Name + "X")
            Set ServoY = Servos.pltem(ObjPinholes.Name + "Y")
            If ((Not ServoX Is Nothing) And (Not ServoY Is Nothing)) Then
                CmbPinhole.AddItem ObjPinholes.Name
            End If
        End If
    Next i
    If (count) Then CmbPinhole.ListIndex = 0    ' select first pinhole

    Set ObjPinholes = Nothing
    Set Servos = Nothing
    Set ServoX = Nothing
    Set ServoY = Nothing
End Sub

```

- Access with external Lsm5Hardware Object

5.2.2.3 Access to hidden Interface

- When do I need to use the hidden Interface?
- How do I find the desired Object / Method?
 - Open Tool / References
 - Browse CP.dll search, open
 - Choose Object Browser Project / Library DS or CP
 - Examine Object Structure

Example:

```

Function GetLaserKind(WaveLength As String, kind As Integer)
    Dim count As Long
    Dim CpObject As Object
    Dim Lines As Object
    Dim i As Long
    Dim Success As Integer
    Dim WaveLenghtOfIndex As Long
    Dim Attenuation As Double
    Dim Enable As Integer
    Dim Name As String

    GetLaserValueMax = False

    Set CpObject = Lsm5.ExternalCpObject()
    Set Lines = CpObject.pHardwareObjects.pLaserLines

    count = Lines.ICount
    For i = 0 To (count - 1)
        Success = Lines.bLineInfo(i, WaveLenghtOfIndex, Attenuation, Enable, Name)
        If (Success And (WaveLenghtOfIndex = WaveLength)) Then
            kind = Lines.AttenuatorType(WaveLenght)

            Set Lines = Nothing
            Set CpObject = Nothing
            Exit Function
        End If
    Next i

    Set Lines = Nothing
    Set CpObject = Nothing

End Function

```

5.2.2.4 Access to scanned pictures

Example:

```

Function ChannelIndexFromChannelName(ChannelName As String, ChannelIndex As Long)
    Dim num As Long, num1 As Long, num2 As Long
    Dim i As Long
    Dim Success As Integer
    Dim DetectionChannel As DsDetectionChannel
    Dim LsmInfo As Lsm5Info
    Dim Recording As DsRecording

    ChannelIndexFromChannelName = False

    Set Recording = Lsm5.DsRecording
    Set LsmInfo = Lsm5.Info
    If (LsmInfo.NumberOfPmtsInSystem(num, num1, num2) = True) Then
        For i = 0 To (num + num1 - 1)
            Set DetectionChannel = Recording.DetectionChannelOfActiveOrder(i, Success)
            If Success Then
                If (StrComp(DetectionChannel.Name, ChannelName) = 0) Then
                    ChannelIndex = i
                    ChannelIndexFromChannelName = True
                    GoTo exit_function
                End If
            End If
        Next i
    End If

    exit_function:
    Set LsmInfo = Nothing
    Set Recording = Nothing
End Function

```

```
Function GetAveragePixel(ScanDoc As DsRecordingDoc, ChannelName As String, mean As Double)
    Dim line As Variant
    Dim x As Long, xmax As Long
    Dim y As Long, ymax As Long
    Dim spl As Long
    Dim bpp As Long
    Dim Sum As Double
    Dim Channel As Long

    GetAverageScanLineParams = False

    If (ChannelIndexFromChannelName(ChannelName, Channel) = False) Then
        Exit Function
    End If

    'check for valid doc
    If (ScanDoc Is Nothing) Then Exit Function
    Sum = 0
    xmax = ScanDoc.Recording.SamplesPerLine
    ymax = ScanDoc.Recording.LinesPerFrame
    For y = 0 To ymax - 1
        line = ScanDoc.ScanLine(Channel, 0, 0, 0, spl, bpp)

        For x = 0 To spl - 1
            Sum = Sum + line(x)
        Next x
    Next y
    mean = Sum / (xmax*ymax)

    GetAverageScanLineParams = True
End Function
```

5.2.2.5 Backup Recording

```

.
.
.
Dim Recording As DsRecording
Dim BackupRecording As DsRecording
Dim ScanDoc As DsRecordingDoc

Set Recording = Lsm5.DsRecording
'create a backup recording
Set BackupRecording = Lsm5.CreateBackupRecording
Success = BackupRecording.Copy(Recording)

Recording.ScanMode = "Line"
Recording.FramesPerStack = 1
Recording.StacksPerRecord = 1
Recording.ScanDirection = eSingleForeward
Recording.SpecialScanMode = "NoSpecialScanMode"
Recording.TimeSeries = False
Recording.ZoomX = ZOOM_X
Recording.ROTATION = ROTATION
Recording.Sample0X = OFFSET_X
Recording.Sample0Y = OFFSET_Y
Recording.SamplesPerLine = IMAGE_SIZE
Recording.StartScanTime = 8

Success = SetChannelDetection(ChannelName, 1, AmpOffset, 100)
Set ScanDoc = Lsm5.StartContinuousScan

.
.
.

Lsm5.StopScan
'restore the backup recording
Recording.Copy BackupRecording
Set Recording = Nothing
Set BackupRecording = Nothing

```

5.2.2.6 Events

- What are Events good for?
- Mouse Events
- Scan state events
- Hardware Events

Private Sub Lsm5VbaDoc_SystemEvent(ByVal EventNr As Long, ByVal Param As Variant)

Dim x As Long

Dim y As Long

Dim z As Long

Dim t As Long

Dim c As Long

Dim tmp As Long

Dim pt As POINT

Dim dsDoc As DsRecordingDoc

'get the active Recording Document

Set dsDoc = Lsm5.DsRecordingActiveDocObject

If (dsDoc Is Nothing) Then Exit Sub

If (Not dsDoc.IsValid) Then Exit Sub

If (EventNr = elmageWindowLeftButtonDownEvent) Then

If dsDoc.GetCurrentMousePosition(c, t, z, y, x) <> 0 Then

' do something

.

.

.

End If

End If

End Sub

CHAPTER 6

TOOLS, ADDITIONAL SOFTWARE

CONTENTS

	Page
6	TOOLS, ADDITIONAL SOFTWARE 2
6.1	3D for LSM 2
6.1.1	Overview and Explanations..... 2
6.1.2	User Interface..... 3
6.1.3	Functions 11
6.2	Change Filters 60
6.3	Stand Select 62
6.4	Maintenance Tool 63
6.4.1	Calibration objective 63
6.4.2	Starting the Maintenance Tool 64
6.4.3	General operation of the Maintenance Tool 64

6 TOOLS, ADDITIONAL SOFTWARE

6.1 3D for LSM

6.1.1 Overview and Explanations

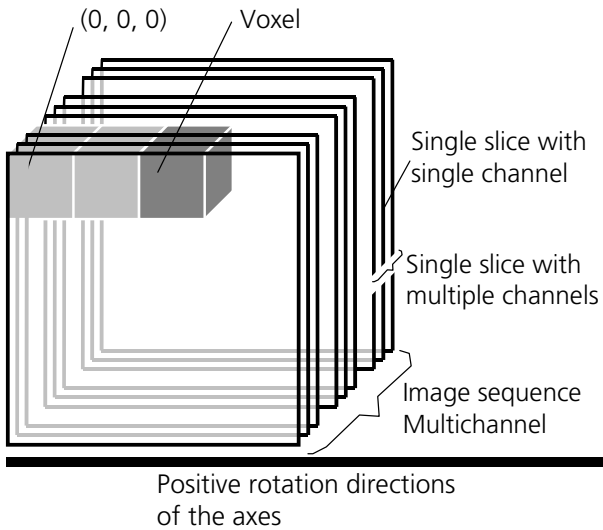


Fig. 1

- A voxel is the smallest element of an image sequence (the equivalent of a pixel in a 2D image). All voxels in a given image sequence are the same size.
- The coordinate system originates in the left upper front corner of the image sequence. This point has the coordinates 0, 0, 0.
- All angles are positive for rotations to the right in the direction of the positive coordinate axis (right-handed coordinate system).
- A slice is an individual image in a sequence of images. The numbering of the slices starts with "1".

Image sequences can consist of several channels. Most functions and the **Display window** are providing buttons to select all or a subset of channels stored in the selected image sequence. The **Output** image sequence will only get those channels which are selected on the input side. The button selects all channels in the image sequence to be used clicking with the left mouse button on it.

Clicking with the left mouse button on any of the number buttons toggles the state of this single channel.

Clicking with the right mouse button on any of the number buttons selects this single channel exclusively. All other channels are deselected.

6.1.1.1 The Image Sequence

The "3D for LSM" handles image sequences generated by the Zeiss LSM software. This can be three-dimensional image data or a time sequence of two-dimensional images (slices). Each slice (as well as the sequence) can consist of up to eight channels. An image sequence consists of a series of individual (2D) images and has a name that designates the entire sequence. In general an image sequence is handled as a single object in the system. Individual channels or slices can be addressed.

The following terms and definitions apply for the "3D for LSM" software.

- An image sequence is a number of individual sequential images (usually called slices in the dialog boxes), the spacing between which is equal.
- Image sequences can contain up to 12 bit of image data (per channel).
- A sequence (slice) can consist of up to eight channels.
- The maximum size of an image sequence is limited by the provided memory of the operating system.

6.1.1.2 The Image Properties

Every image sequence has its own set of properties. They contain the scaling and the scaling units. The scaling and its units are required for 3D reconstruction and measurement. If a sequence of LSM-TIFF images is read in, the image properties are loaded automatically from the file header and allocated to the image properties of the new image sequence.

6.1.1.3 Memory Usage

All images shown in the **Gallery** are currently loaded in the system memory of the operating system. Some functions need additional temporarily used memory during their execution.

If the memory is running low delete some images from the **Gallery**. If the images are needed afterwards they must be saved to disk first. Normally all functions produce a new result (output) image sequence. In order to save some memory, other image sequences currently presented in the **Gallery** can be selected as result position. The output image is overwritten by entry execution of a function.

6.1.2 User Interface

6.1.2.1 Introduction

This section describes the following main components of the system:

Main window **Main window** with the **Menu**, the **Tool bar** and **Gallery**. All general system functions are located here.

Gallery Normally several images are required in order to accomplish a particular task. These images are displayed in reduced size to provide an overview and facilitate selection. This area is located just below the **Tool bar**.

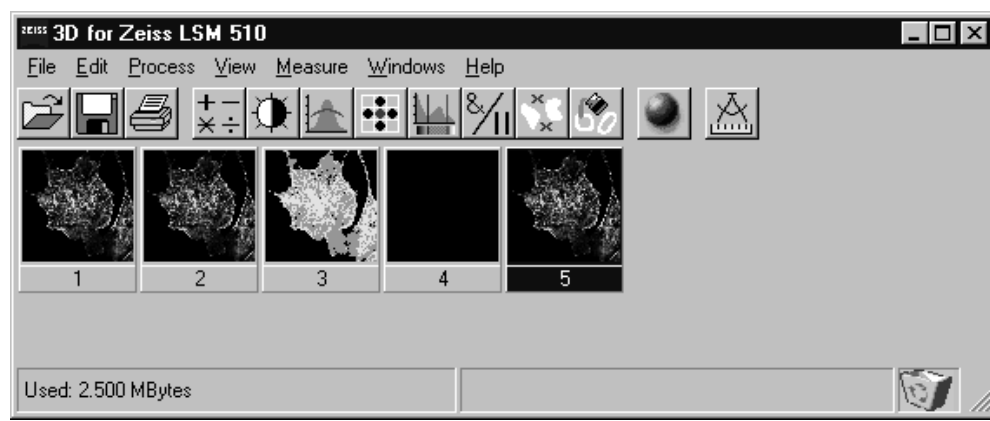


Fig. 2

Tool bar This menu shows all image processing functions.

Display window This window is used to display image sequences.

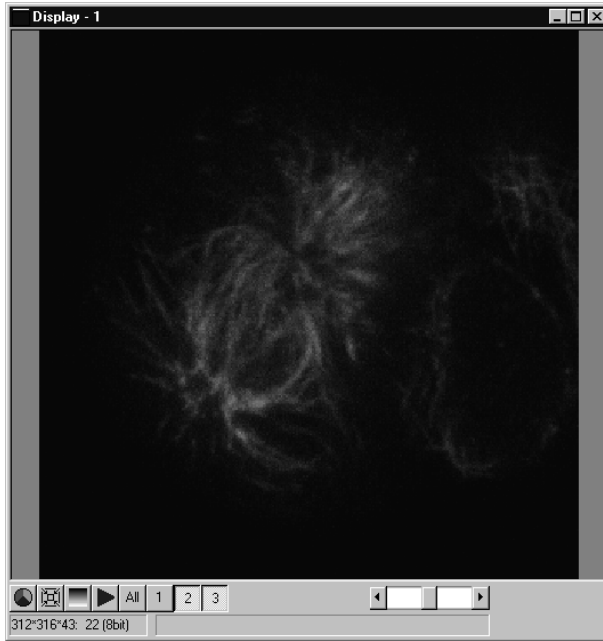


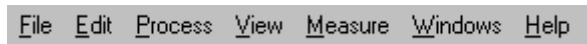
Fig. 3 Display window

Dialog boxes All dialog boxes provide three buttons. Pressing the **OK** button executes the function with the defined parameters and closes the dialog window. Selecting the **Cancel** button does not execute the function, restores the parameters, and closes the dialog window. Pressing the **Apply** button executes the function with the defined parameters; the dialog window will stay opened.

6.1.2.2 Main Window

The **Main window** includes:

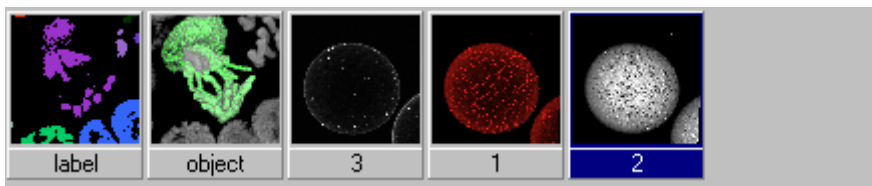
the **Menu**



the **Tool bar**



and the **Gallery**



File Menu



Open Image

Opens a file selector dialog to load an image sequence.



Save Image As

Opens a file selector to save an image or image sequence.

Save Display As

Saves the currently shown contents of the Display window as a single colour image.



Print

The printer parameters can be set with this tool. The standard Windows printer dialog is opened.

Exit

Terminates the application.

Edit Menu

Copy

Copies the contents of the **Display window** to the clipboard.

Edit Channels

Allows to add or to remove channels to a single or multichannel image.

Delete All Images

Deletes all images and image sequences from the memory.

Process Menu



Arithmetics

Adds or subtracts the grey values of two image sequences (**Add, Subtract**).



Contrast

Enhances the contrast and brightness of an image sequence (**Interactive, Automatic, Linearize**).



Smooth

Smooths an image sequence.



Morphology

Performs morphological operations on image sequences (**Erode, Dilate, Open, Close**).



Segment

Segmentates an image sequence to propose measurement (**Interactive, Automatic**).



Boolean

Combines two image sequences by Boolean operations (**And, Or, Not, Xor, Mask**).

**Scrap**

Selects or deletes objects of a defined size.

**Fill Holes**

Fills holes in objects.

View Menu**Set Channel Colour** The colour and the weight of the single channels can be defined.**Properties** The properties of the image (e.g. scaling, use laser etc.) are displayed.**Render**

Calculates 3D reconstructions of an image sequence (Surface, Alpha).

Measurement Menu**Automatic Object**Measures geometrical and densitometrical features (**General, Object Features, Volume Features, Condition**).**Windows Menu****Arrange All** Arranges the windows automatically.**Display** The current image is displayed in this window.**Help Menu****Content** Opens the help for the software.**About 3D for LSM** Displays status and release message of the software.**Tool Bar**

This bar provides buttons with iconized images of nearly all functions. Clicking on one of the buttons will open a dialog window to define the function parameters. Selecting an entry from the menu alternatively can activate the same functions. Placing the cursor on a tool bar button will show a short description, if the window is activated.

Gallery


The **Gallery** is used as an overview of the images available in memory and their contents. It is located just below the **Tool bar**. Each small image represents a sequence. The middle slice of each image sequence is shown. The status bar of each image shows the name. The name might be a number or a string.

Every image sequence has its own channel colour assignment (see **Display window**). When an image is copied the channel colour assignment is copied too. Drag and drop techniques can be applied to copy images or define the function parameters **Input** and **Output** using the **Gallery** thumbnails.

- Position the cursor on an image in the **Gallery**.
- Press the left mouse button.
- Hold the mouse button down and move the mouse to the destination position.
- At the destination release the left mouse button, the destination image will be overwritten.

To delete an image, drag it, move it to the wastebasket, and drop it.

6.1.2.3 Display Window

This window is used to display an image sequence, regardless of size or type. To show multiple channel sequences each channel could have its own base colour. The user can set these colours and the weighting for each channel by pressing the corresponding button  at the bottom of the window. To display a different image or image sequence, it can be dragged from the **Gallery** and dropped to the **Display window**.

The image can be displayed in full size (one pixel on the screen represents one pixel of the image) or in a zoomed size. To zoom the display view click and hold down the right mouse button on the window border and resize the window. The aspect ratio of the image will not be changed. Clicking on the button



resets the **Display window** to a full size view of the image (see above).



The title bar shows the currently displayed sequence name. The status bar displays the size of the current sequence and the selected slice on the left. On the right the cursor position within the window and the corresponding intensity (grey) value of each channel is shown.

The **Display window** can be closed without any effect to the image processing functions. If no **Display window** is opened select the entry **Display** in the **Window menu**.

The scroll bar at the lower right of the window enables to show the images in a sequence. The range reaches from one to the maximum slice provided by the current sequence.

To start the automatic animation of an image sequence start the Player tool by clicking on the button



. The colour selection for the channels can be activated by clicking on the button . A colour image can be displayed as a grey value image by clicking on the button .

Player

This function plays back the sequential images of an image sequence.

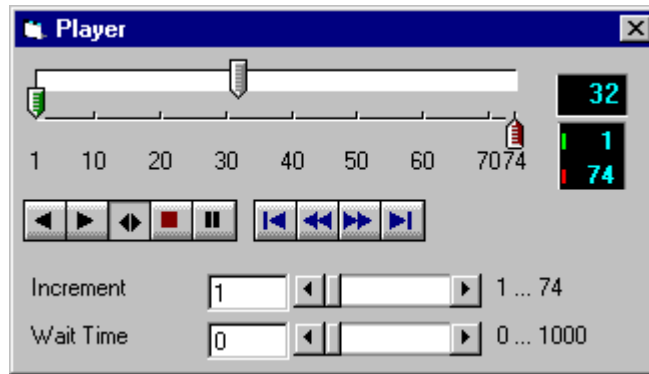


Fig. 4

The image sequence is displayed in the **Display window**. The display process is working as a background task; other functions can be executed while the player is running. There are several ways to stop the player:

by closing the player window

by pushing the red Stop button of the player window (the window remains open)

by closing the image window.

The **Increment** parameter specifies whether each sequential image (1) should be displayed or whether some sequential images should be skipped during display. The value 2 skips one image for every sequential image displayed, in other words, it displays only every second image.

The parameter **Wait Time** states the delay in milliseconds between two successive sequential images. The maximum display speed depends mainly on the hardware. The sequential images are always displayed in their entirety, regardless of the set delay.

Control Element of the Player

The three arrow shaped controls on the scale show the start slice and the currently displayed sequential image. The values (positions) can be changed using the mouse. Press and hold the left mouse button and move the pointer to the desired position. The set values are shown in the numerical windows at right.



Start slice



Currently displayed sequential image



End slice

The buttons in the left group start and stop playback of an image sequence.



Reverse playback



Forward playback



Play forward and then backward again (jojo)



Stop playback



Pause playback

The buttons in the middle group control the settings of the current sequential image.



Reset to start slice.



Single step backward (1 sequential image each regardless of Increment).



Single step forward (1 sequential image each regardless of Increment).



Set to end slice.

Increment Image increment.

Wait Time Displays delay between two images (in milliseconds).

Set Channel Colour

This function sets the colour and weight for the channels.

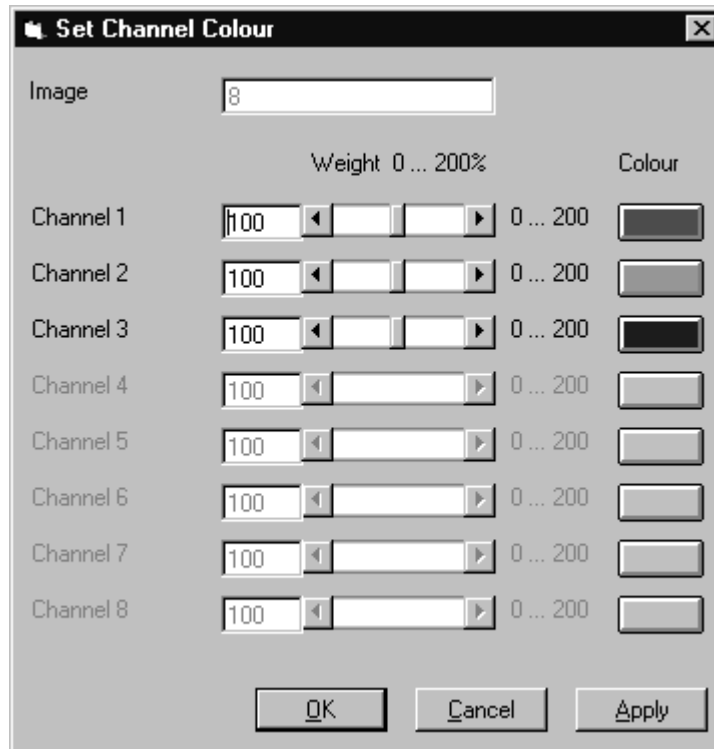


Fig. 5

Each image sequence can get its own colour definitions. All functions will inherit the colour definition from the **Input** sequence to the **Output** sequence. By default the colours are set to 100 % weighting and the pure base colours (red, green, blue) are defined.

The weight can be any value between 0 % and 200 %. The colour can be redefined by clicking on the coloured button on the right of the dialog. The standard Windows colour selection dialog is opened. The solution is done by clicking on one of the colours or by entering appropriate numbers in the corresponding edit boxes.

Pressing the **OK** button will close the colour selection dialog and update the **Display window** immediately.

Only those channels, which are available in the image sequence, can be defined.

Parameters:

Image	Image sequence to edit
Weight	Colour weighting for each channel
Colour	Base colour for each channel

6.1.3 Functions

6.1.3.1 Functions in the File Menu

Open Image

This function reads a Zeiss LSM (*.lsm), Zeiss LSM TIFF (*.000.tif) or Carl Zeiss Vision (*.img) image sequence from a disk or network drive.

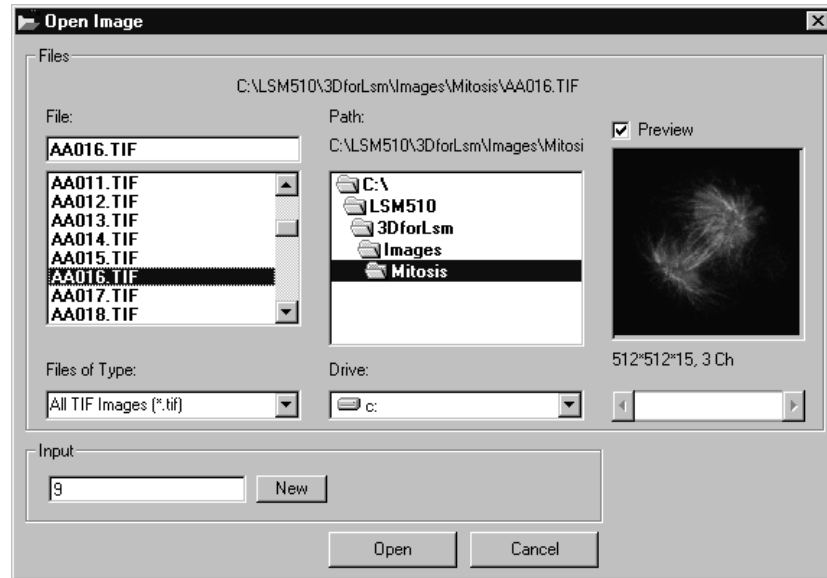


Fig. 6

The individual files of a Zeiss TIFF image sequence are read and saved as an image sequence in image memory. In addition, the image properties are read out of the TIFF files and allocated to the image sequence **Input**.

The directories of the current drive are listed in the **Directories** list box. Use the **Drives** list box to choose a different drive.

In case of choosing the TIFF-format in the **Files of Type** box, three number characters are always expected before the dot in the filename extension. The first number must be 000 at the end of the filename. From a complete sequence only this file is listed in the dialog, if "LSM TIF Images (*.000.tif)" is selected in the **Files of Type** box. To view all TIFF files "All TIF Images (*.tif)" in the **Files of Type** box must be selected. This selection enables to start with a different file than with the very first (named *.000.tif) at the end of the filenames three number digits.

Currently the Carl Zeiss Vision file format "KE Images (*.img)" is supported. Two files per channel are saved.

Carl Zeiss Vision image sequences must have a number digit at the end of the base filename. They are used to indicate the different channels in a multichannel sequence. The numbering starts with zero (0). If a sequence is saved in the Carl Zeiss Vision format the numbers are generated automatically. To load such an image sequence "KE Images (*0.img)" in the **Files of Type** box must be selected.

The window incorporates the usual file selection controls. The bottom half displays a selection of the image properties that are stored in the image sequence.

Parameters:

- BaseName** Base name of the TIFF files (image sequence) to be loaded. Only the letters before the first number are stated.
- Input** Name of the resulting image in which the image sequence will be saved.

Save Image As

This function saves an image or image sequence to disk or network drive.

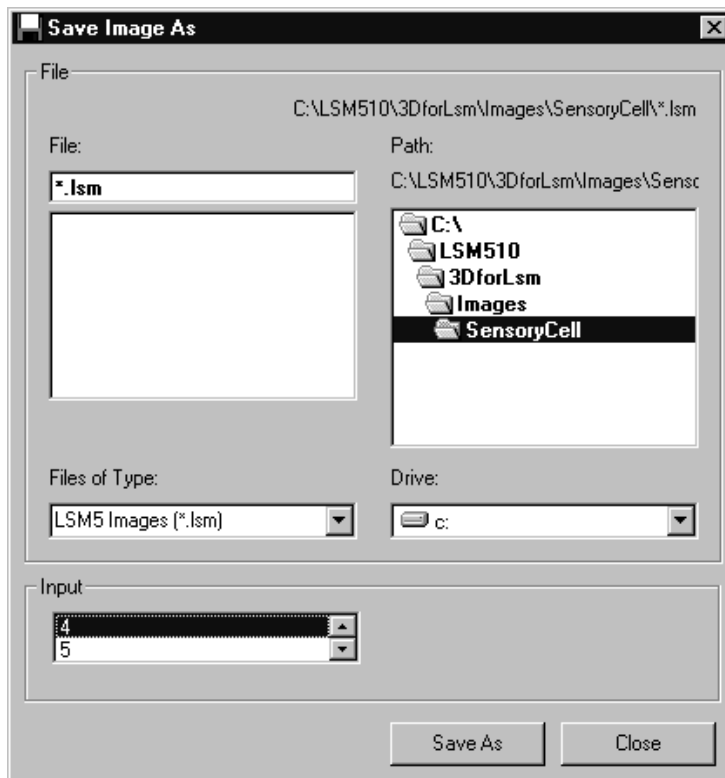


Fig. 7

All the files in the current directory that have the selected image format are listed in the **File Name** list box.

The directories of the current drive are listed in the **Directories** list box. Use the **Drives** list box to choose a different drive.

Use the list box **Files of Type** to select the image format. Currently the LSM image format (*.ism) and the Carl Zeiss Vision file format "KE Images (*0.img)" is supported.

By choosing the Carl Zeiss Vision file format "KE Images (*.img)", two files per channel are saved. On one hand the Carl Zeiss Vision type image sequence file, on the other hand the file with the image properties. One pair of files is written per channel. They are numbered automatically, starting with zero. A one number digit is added to the end of the filenames. The two files share the same filename but have different filename extensions (*.img and *.3d).

The content of the **Gallery** is shown in the **Input** section. The selection of the sequence to save is done by highlighting one of the provided names or by drag and drop from the **Gallery**.

Parameters:

Input Name of the image sequence to be saved

Filename Name of the file to be used on disk

Save Display As

This function saves the current **Display window** contents to a disk or network drive.



Fig. 8

Before the execution of this function any image or image sequence can be selected to be displayed. From a multichannel sequence any channel status (on or off) combination can be defined. The colours of the shown channels can be set with the function **Set Channel Colour**.

The current zoom factor of the **Display window** is not taken into account, the image is saved without any zoom.

The image is saved as a true colour image with 24-bit resolution. From the **Save as Type** list box one of the provided formats can be selected.

Parameters:

None

Print

This function prints the current **Display window** contents.

The standard Windows print dialog is opened.

Before the execution of this function any image or image sequence can be selected to be displayed. From a multichannel sequence any channel status (on or off) combination can be defined. The colours of the shown channels can be set with the function **Set Channel Colour**.

Parameters:

None

Exit

This function terminates the application completely.

All images and image sequences shown in the **Gallery** will be deleted from the memory. Save those images which might be used for any further processing.

Parameters:

None

6.1.3.2 Functions in the Edit Menu

Copy

This function copies the current **Display window** contents to the clipboard. No dialog is shown.

Before the execution of this function any image or image sequence can be selected to be displayed. From a multichannel sequence any channel status (on or off) combination can be defined. The colours of the shown channels can be set with the function **Set Channel Colour**.

The current zoom factor of the **Display window** is not taken into account; the image is copied without any zoom.

The image is copied as a true colour image with 24-bit resolution. Afterwards the contents can be pasted to any other Windows application.

Parameters:

None

Edit Channels

This function allows to add or to remove channels to a single or multichannel image.

On the **Add Channel** tab sheet the channels of (different) **Input** sequences can be defined to add (combine) channels to an **Output** sequence.

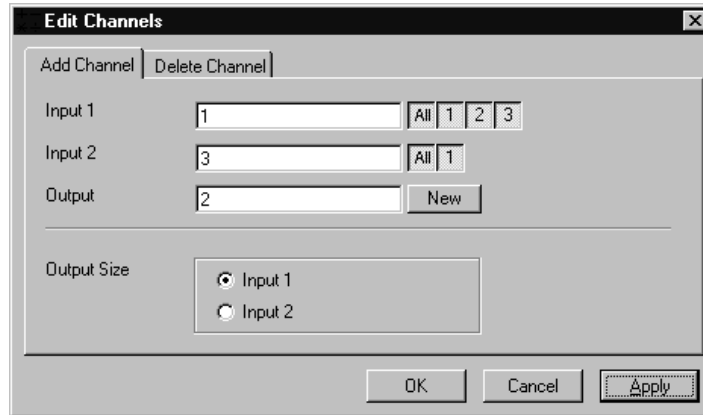


Fig. 9

This operation is useful to add a segmented channel (or any other result of a function) to the original image sequence. The selected channels of **Input 1** and **Input 2** are copied to **Output**. The maximum number of channels in an image sequence is eight.

If the image sequences do not have the same extents **Output Size** defines which input is taken as a reference. This selection also defines the properties for scaling and units in the output image sequences.

Parameters:

- Input 1** First input image sequence
- Input 2** Second input image sequence
- Output** Output image sequence
- Output size** Defines source image sequence for size, scaling, and units

On the **Delete Channel** tab sheet channels of the **Input 1** image sequence can be selected to delete channels.



Fig. 10

This operation might save time and memory for further processing if not all channels are needed. Only the selected channels of **Input 1** are copied to **Output**.

Parameters:

Input 1	Input image sequence
Output	Output image sequence

Delete All Images

This function deletes all images and image sequences from the memory (**Gallery**).

The function is used whenever a completely new image sequence should be processed. In order to drop the images item by item to the wastebasket all of them can be deleted by a single function.

If any image or image sequence is needed for further use save them first.

Parameters:

None

6.1.3.3 Functions in the Process Menu

Arithmetics - Add

This function adds two image sequences.

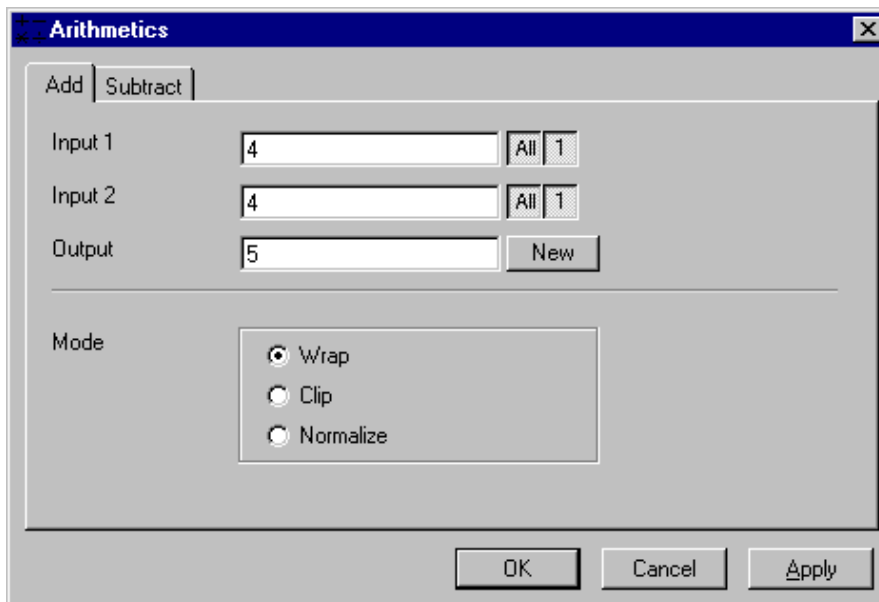


Fig. 11

The **Add** tab sheet of the **Arithmetics** dialog window must be selected.

If one or both input sequences are multichannel sequence, any number or combination can be selected. The number of selected channels for **Input 1** and **Input 2** must be the same. They will be combined from left to right.

This function adds the two image sequences **Input 1** and **Input 2** voxel by voxel and generates the image sequence **Output**. Note that a resulting grey value may be greater than 255 (4095). The parameter **Mode** determines how a range overflow is handled:

- | | |
|---------------|---|
| 1 - Wrap | No normalization - the grey values are displayed modulo 256 (4096). If the result is greater than 255 (4095), the value 256 (4096) is subtracted from it. |
| 2 - Clip | Grey values which exceed 255 (4095) are replaced with 255 (4095). |
| 3 - Normalize | The resulting grey value range is scaled to the range 0...255 (0...4095). |

Parameters:

- | | |
|----------------|---------------------------------------|
| Input 1 | First input image sequence |
| Input 2 | Second input image sequence |
| Output | Output image sequence |
| Mode | 1 - Wrap
2 - Clip
3 - Normalize |

Arithmetics - Subtract

This function subtracts two image sequences.

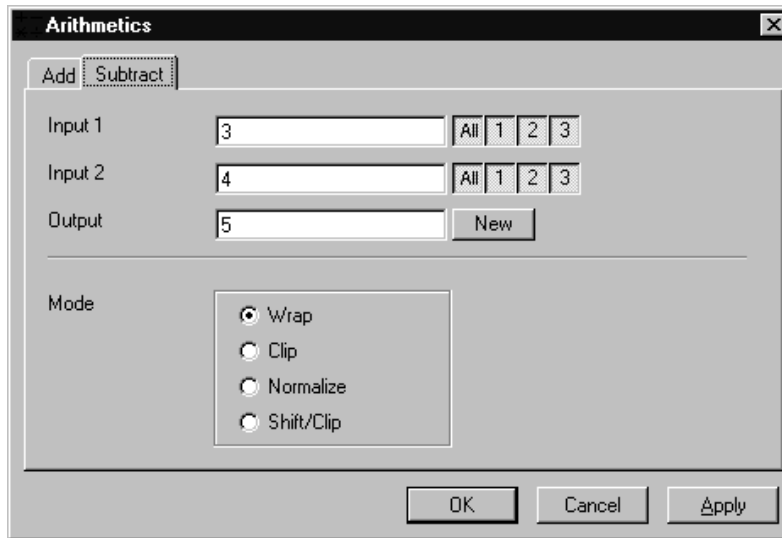


Fig. 12

The **Subtract** tab sheet of the **Arithmetics** dialog window must be selected.

If one or both input sequences are multichannel sequence, any number or combination can be selected. The number of selected channels for **Input 1** and **Input 2** must be the same. They will be combined from left to right.

This function subtracts the two image sequences **Input 1** and **Input 2** voxel by voxel and generates the image sequence **Output**. Note that a resulting grey value may be less than 0. The parameter **Mode** determines how a range overflow (negative values) is handled.

- | | |
|----------------|--|
| 1 - Wrap | No normalization - the grey values are displayed modulo 256 (4096). If the result is less than 0, the value 256 (4096) is added to it. |
| 2 - Clip | Negative values are set to 0. |
| 3 - Normalize | The resulting grey value range is scaled to the range 0...255 (0...4095). |
| 4 - Shift/Clip | 128 (2048) is added to the difference, then negative values are set to 0. Values greater than 255 (4095) are set to 255 (4095). |

Parameters:

- | | |
|----------------|---|
| Input 1 | First input image sequence |
| Input 2 | Second input image sequence |
| Output | Output image sequence |
| Mode | 1 - Wrap
2 - Clip
3 - Normalize
4 - Shift/Clip |

Contrast - Interactive

This function allows interactive changes of the contrast of an image sequence.

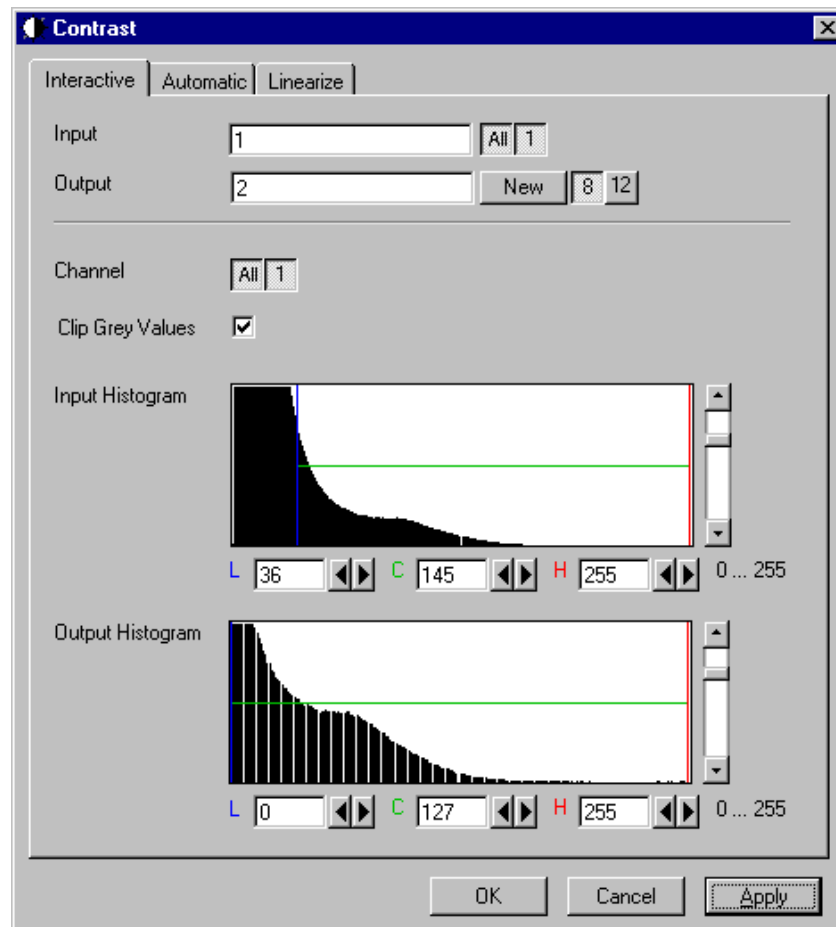


Fig. 13

The **Interactive** tab sheet of the **Contrast** dialog window must be selected.

A grey value range of the **Input** image sequence is scaled to another range in the **Output** image sequence. Both ranges can be edited interactively. This function is used to achieve a better view of an image sequence, or to scale a range of grey values to single value for a special coding in an image sequence. The function does not improve the result of the linear segmentation function **Segment**.


Input indicates the sequence to enhance. If it is a multichannel sequence, a single channel, all channels, or any number can be selected. The **Input** histogram shows the grey value distribution of the selected channels of the **Input** image sequence.

Output defines the name of the result sequence. It will get only those channels which are chosen by the **Input** parameter. The buttons labeled with 8 and 12 define the grey value (intensity) resolution in bit. Normally the result will get the same resolution as the **Input** sequence. A change will be needed if image sequences with different resolutions should be combined. Raising the grey value range to 12 bit will not enhance the display quality or measurement accuracy. The smooth and morphology functions will produce results with finer gradations.

If **Clip Grey Values** is selected, the output grey values are clipped to the **Low (L)** and **High (H)** values. If **Clip Grey Values** is not selected, output grey values beyond the **Low** and **High** value range are possible.

The **Output** histogram shows the resulting histogram. The horizontal axis represents the grey values from 0 to the maximum, which is either 255 or 4095, depending whether the input is 8 bit or 12 bit. The vertical axis represents the pixel count. The selected range is marked by the borderlines in the histogram. The blue line or **L** indicates the lower boundary, the red line or **H** the upper one, **C** indicates the center of the range.

There are three ways to change the range: clicking and dragging the borderlines with the mouse.

Entering a new value in the appropriate text boxes, clicking on the buttons  or using the arrow keys from the keyboard. To alter the values within the histogram move the mouse pointer over one of the three coloured lines until the shape changes. Press and hold the left mouse button to move the line to a new position. To change the values with the arrow keys click once into the histogram. Using the left or right arrow key by its own will move the whole range. Pressing the **Shift** key additionally moves the lower boundary, the **Control** key the upper boundary.

The vertical scale of the histogram is set using the scroll bar. The units are percents of the maximum grey value distribution. This setting has no influence on the function.

Parameters:

Input	Input image sequence
Output	Output image sequence
Channel	Selection of the channel numbers for the Output image after contrast enhancement
Clip Grey Values	Clipping of grey values to the Low (L) and High (H) output grey values boundaries
Input L	Lower boundary of grey value range Input
Input C	Center of grey value range Input
Input H	Upper boundary of grey value range Input
Output L	Lower boundary of grey value range Output
Output C	Center of grey value range Output
Output H	Upper boundary of grey value range Output

Contrast - Automatic

This function scales the grey values of an image sequence to the maximum possible range.

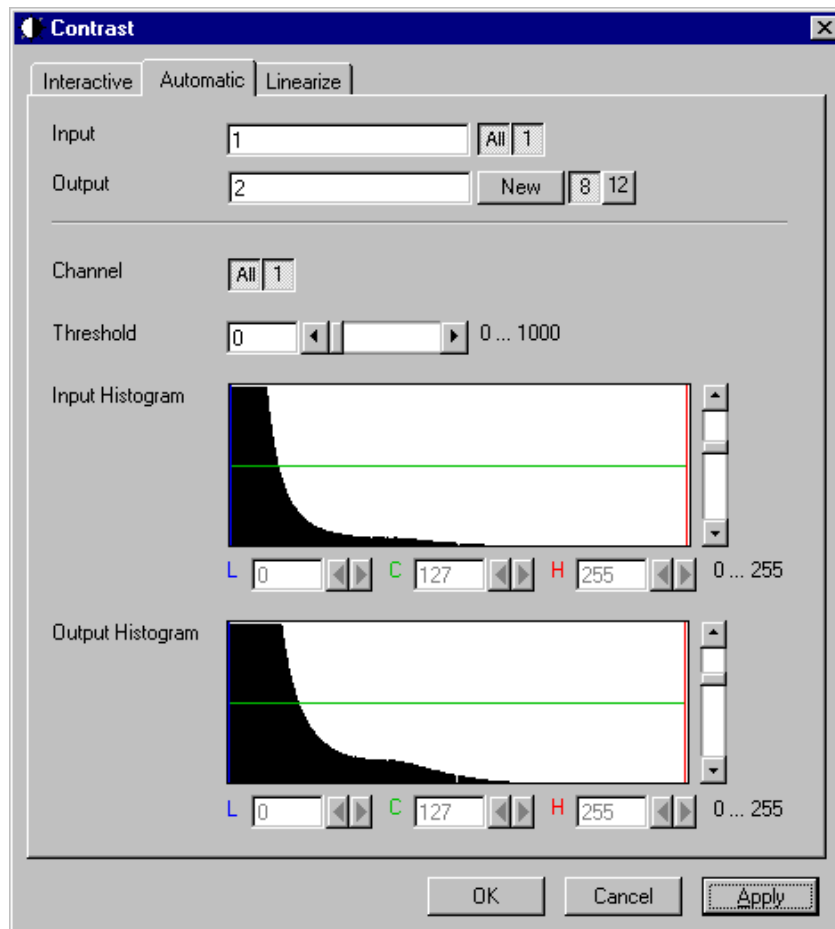


Fig. 14

The **Automatic** tab sheet of the **Contrast** dialog window must be selected.

This function enhances the contrast of an image sequence by spreading the grey value distribution over the maximum possible range. This function is used to achieve a better view of an image.

The light and dark grey value ranges with a low share of pixels are excluded from the operation by the parameter **Threshold**. The **Threshold** units are in thousandths of the total number of voxels. Using a value of 10 means that the scale interval is set so that 5/1000 of the total number of voxels on the light side, and 5/1000 of the total number of voxels on the dark side of the grey value distribution are excluded.

Input indicates the sequence to enhance. If it is a multichannel sequence, a single channel, all channels, or any number can be selected. The **Input** histogram shows the grey value distribution of the selected channels of the **Input** image sequence.

Output defines the name of the result sequence. It will get only those channels which are chosen by the **Input** parameter. The buttons labeled with 8 and 12 define the grey value (intensity) resolution in bit. Normally the result will get the same resolution as the **Input** sequence. A change will be needed if image sequences with different resolutions should be combined. Raising the grey value range to 12 bit will not enhance the display quality or measurement accuracy. The smooth and morphology functions will produce results with finer gradations.

The **Output** histogram shows the resulting histogram. They are not editable. The horizontal axis represents the grey values from 0 to the maximum, which is either 255 or 4095, depending whether the input is 8 bit or 12 bit. The vertical axis represents the pixel count. The vertical scale of the histogram is set using the scroll bar. The units are percentages of the grey value distribution maximum. This setting has no influence on the function.

Parameters:

Input	Input image sequence
Output	Output image sequence
Threshold	Exclusion value - 0...1000
Input L	Lower boundary of grey value range Input
Input C	Center of grey value range Input
Input H	Upper boundary of grey value range Input
Output L	Lower boundary of grey value range Output
Output C	Center of grey value range Output
Output H	Upper boundary of grey value range Output

Contrast – Linearize

This function scales a range of grey values of an image sequence to equal area fractions in the histogram.

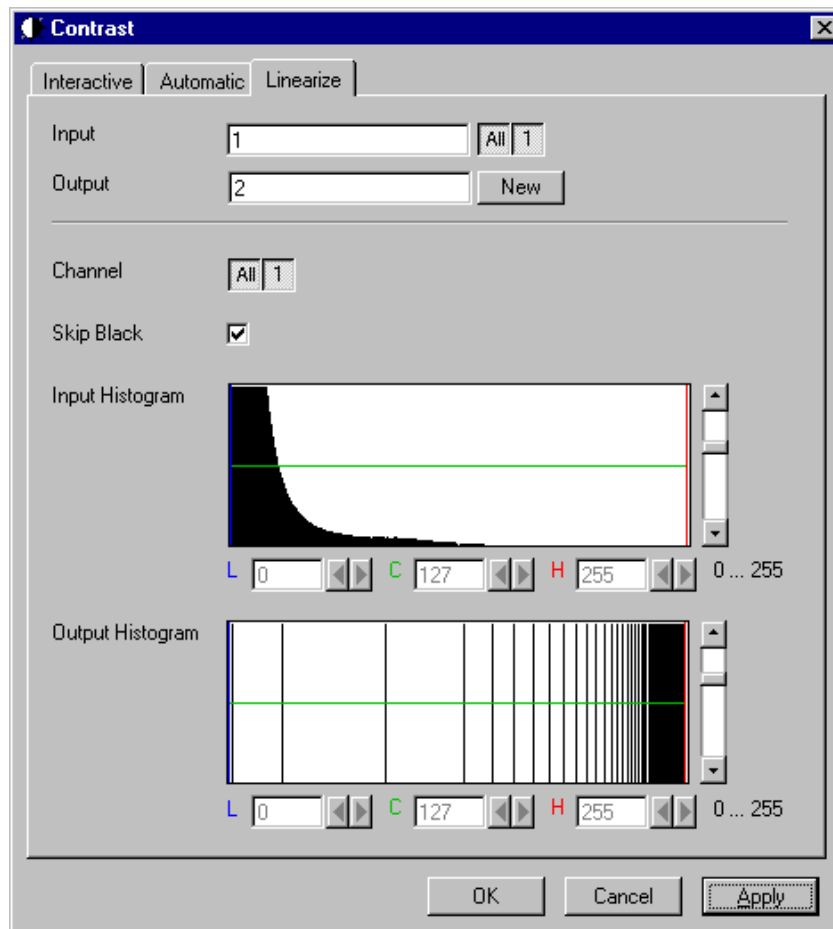


Fig. 15

The **Linearize** tab sheet of the **Contrast** dialog window must be selected.

This function enhances the contrast by linearizing the histogram of the image sequence to equal area fractions in the histogram. The areas (voxel count multiplied by grey value range) of all grey values in the **Output** histogram are the same. This function is used to achieve a better view of an image sequence. When **Skip Black** is checked the grey value 0 will not be taken into account for linearization.

Input indicates the sequence to enhance. If it is a multichannel sequence, a single channel, all channels, or any number can be selected. The **Input** histogram shows the grey value distribution of the selected channels of the **Input** image sequence.

Output defines the range of the result sequence. It will get only these channels which are chosen by the **Input** parameter. The grey value (intensity) resolution will be the same as the one from **Input**.

The **Output** histogram shows the resulting histogram. The horizontal axis represents the grey values from 0 to 255. The vertical axis represents the pixel count. The vertical scale of the histogram is set using the scroll bar. The units are percentages of the grey value distribution maximum. This setting has no influence to the function.

Parameters:

Image	Input image sequence
Output	Output image sequence
SkipBlack	0 - Grey value black is ignored 1 - Grey value black is taken into account
Input L	Lower boundary of grey value range Input
Input C	Center of grey value range Input
Input H	Upper boundary of grey value range Input
Output L	Lower boundary of grey value range Output
Output C	Center of grey value range Output
Output H	Upper boundary of grey value range Output

Smooth (Gauss)

This function performs a Gauss filter.



Fig. 16

The noise in the image sequence is reduced, the edge shape is nearly unchanged, local maxima are leveled, the dynamic range is reduced.

Image sequences should be smoothed before they are reconstructed or segmented. For most sequences a **Size** value of 3 is sufficient enough. If **Input** is a multichannel sequence, any number and combination of channels can be selected. **Output** will only get the selected channels as results.

The grey value of every pixel is substituted by a weighted average of its surrounding neighbors. The neighbors are defined by a cube. The affected pixel is the central pixel of the filter cube. The weighted filter cube is approximated by a binomial distribution. The size of the filter cube is set using the **Size** scroll bar. Even numbers are set to the next odd value. The **Size** defines the strength of the smoothing.

Parameters:

Input	Input image sequence
Output	Output image sequence
Size	Filter size (3...31, only odd numbers)

Morphology

The following four functions perform basic operations of mathematical morphology on image sequences.

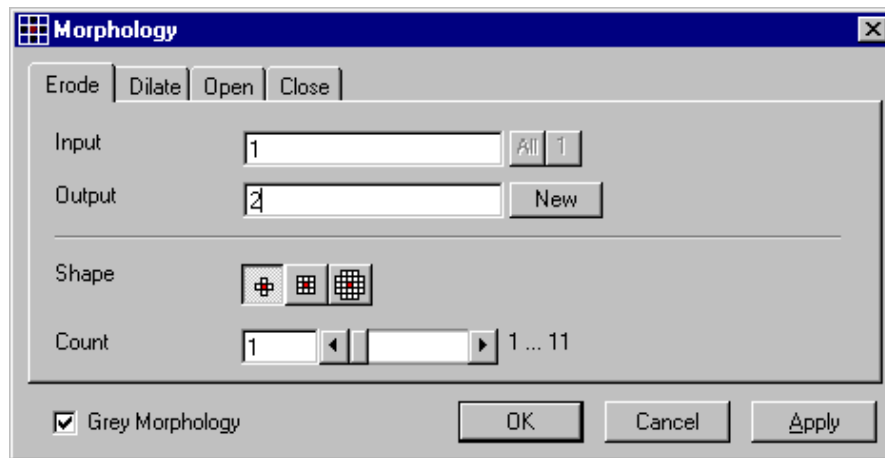


Fig. 17

As generalization of the morphology of two-dimensional images to three dimensions the structural elements are small volumina.

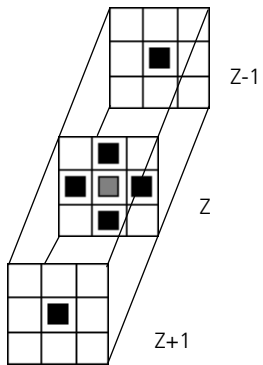
Literature

- Bomans, M.; Höhne, K.-H.; Tiede, U.; Riemer, M.:
3D-Segmentation of MR Images of the Head for 3-D Display
IEEE Transactions on Medical Imaging 9, 1990, 177-183
- Schiemann, T.; Bomans, M.; Tiede, U.; Höhne, K.-H.:
Interactive 3D-Segmentation of Tomographic Image Volumes
14. DAGM-Symposium Mustererkennung, Springer-Verlag 1992, 73-80

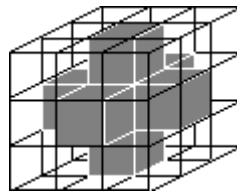
The input image sequence is analyzed voxel by voxel with a selected shape (**Shape**). The voxel to be analyzed is always the central voxel of the shape. The shape type determines which neighboring voxels are used to compute the resulting voxel.

The following structural elements are available for all morphological operations. They represent approximated spheres with an increasing radius.

Sequential image:

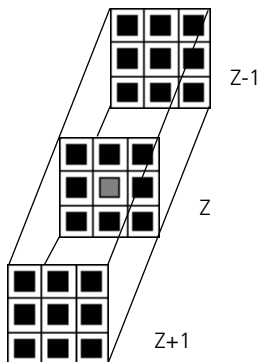


Volume view:

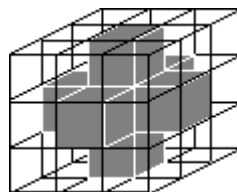


Cross shape

Sequential image:

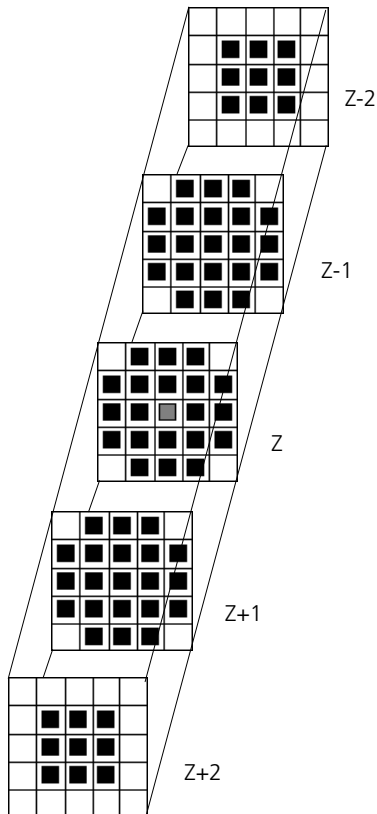


Volume view:

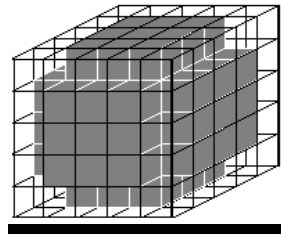


Cross shape

Sequential image:



Volume view:



Cube cross shape: created through application of "cube" and "cross" one after the other.

For regions (voxels) that are at the edge of the image sequence, it is assumed for erosion that there are white voxels with a grey value of 255 (4095) outside the edge. For dilation, it is assumed that there are black voxels with the grey value 0 outside the image sequence.

If the **Grey Morphology** checkbox is activated, erosion sets the grey value of the central voxel to the minimum of all neighboring voxels affected by the structural element; dilation sets the grey value of the central voxel to the maximum.

If the **Grey Morphology** checkbox is not activated, the neighboring voxels are only distinguished by grey value 0 and non-0. For erosion the central voxel is set to 0 if any of the neighbors is 0. It is set to 255 (4095) if any neighbor is not 0. For dilation the central voxel is set to 255 (4095) if any of the neighbors is not 0. It is set to 0 if all neighbors are 0.

Erosion reduces the size of bright regions, separates thin connections between them, and makes small regions disappear. Dilation, on the other hand, makes bright regions of the image grow in size, fills gaps, and smoothes small contour details.

The result of erosion and dilation is called opening. On the one hand, this maintains to some extent the original size of the regions while not losing the smoothing effect of erosion on the image. This name stands for the operation of reducing convex bulges in the contour of the region. Thin connections between regions are eliminated, broken borders between regions are connected, and small regions disappear.

The opposite operation (first dilation, then erosion) is called closing. Concave bulges in the contours of regions are filled in; connections are formed between adjacent regions.

The following example illustrates the operations "Open" and "Close" in two dimensions:

Open = Erosion + Dilation

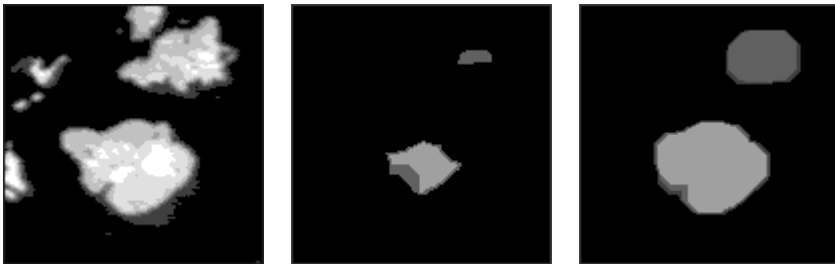


Fig. 18

Close = Dilation + Erosion



Fig. 19

The "cube cross" shape was used for the operations shown.

Morphology - Erode

This function erodes structures in an image sequence.

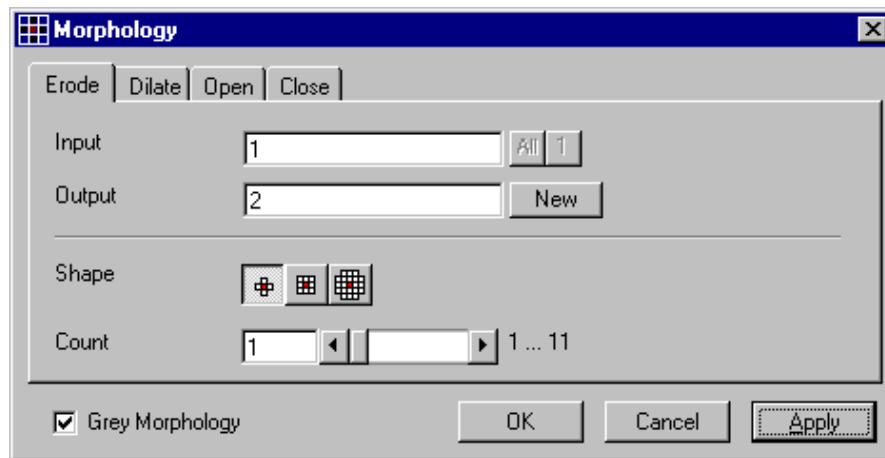


Fig. 20

In the **Morphology** dialog window, the tab sheet **Erode** must be selected.

Erosion makes bright regions smaller on a dark background. It also results in separation of thin connections between regions. Small regions disappear entirely.

If **Input** is a multichannel sequence any number and combination of channels can be selected. **Output** will only get the selected channels as results. The Input image sequence is eroded **Count** times with the shape **Shape**. The **Count** scroll bar determines the number of recursive operations.

The following shapes (numbered 1 to 3 from left to right) are available:



If **Grey Morphology** is selected the function will respect all grey value shades of the sequence **Input**. If **Grey Morphology** is not selected the function will distinguish between 0 and non-0 only. The result **Output** will be a binary sequence.

Parameters:

Input	Input image sequence
Output	Resulting image sequence
Shape	Shape used 1 - cross 2 - cube 3 - cube cross
Count	Number of recursive operations
Grey Morphology	0 - Distinguish between 0 and non 0 only 1 - All grey value shades are taken into account

Morphology - Dilate

This function dilates structures in an image sequence.

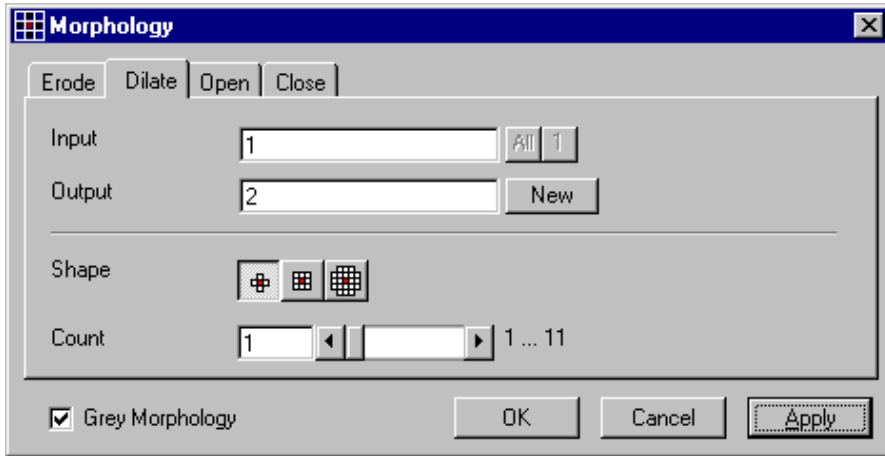


Fig. 21

In the **Morphology** dialog window, the tab sheet **Dilate** must be selected.

Dilation makes bright regions larger on a dark background. It also results in the filling of gaps and smoothing of small contour details.

If **Input** is a multichannel sequence any number and combination of channels can be selected. **Output** will only get the selected channels as results.

The **Input** sequential image is dilated **Count** times with the shape **Shape**. The **Count** scroll bar determines the number of recursive operations.

The following shapes (numbered 1 to 3 from left to right) are available:



If **Grey Morphology** is selected the function will respect all grey value shades of the sequence **Input**. If **Grey Morphology** is not selected the function will distinguish between 0 and non-0 only. The result **Output** will be a binary sequence.

Parameters:

Input	Input image sequence
Output	Resulting image sequence
Shape	Shape used 1 - cross 2 - cube 3 - cube cross
Count	Number of recursive operations
Grey Morphology	0 - Distinguish between 0 and non 0 only 1 - All grey value shades are taken into account

Morphology - Open

This function carries out an opening.

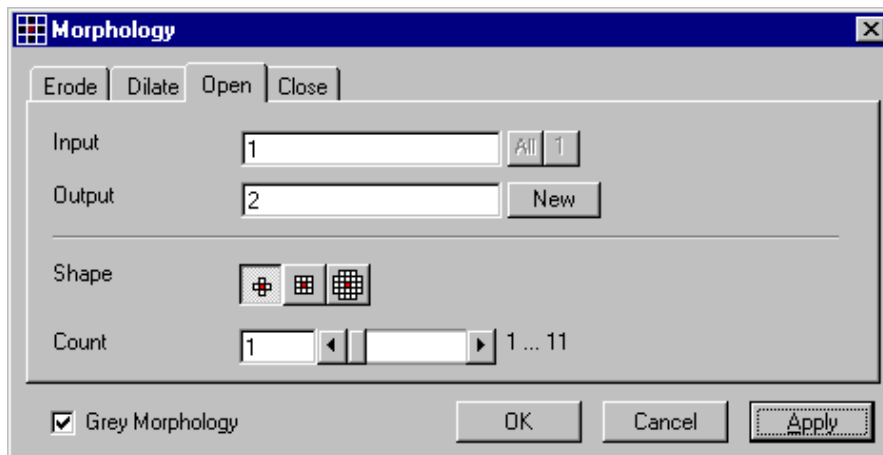


Fig. 22

In the **Morphology** dialog window, the tab sheet **Open** must be selected.

This function carries out an erosion followed by a dilation. For the most part, the opening maintains the original size of the regions. Thin connections between regions and small regions themselves disappear. Convex bulges in the contours of the regions are reduced. The opening is applied to the grey value image sequence **Input Count** times with the shape **Shape**. If **Input** is a multichannel sequence any number and combination of channels can be selected. **Output** will only get the selected channels as results.

The **Count** scroll bar determines the number of recursive operations.

The following shapes (numbered 1 to 3 from left to right) are available:



If **Grey Morphology** is selected the function will respect all grey value shades of the sequence **Input**. If **Grey Morphology** is not selected the function will distinguish between 0 and non-0 only. The result **Output** will be a binary sequence.

Parameters:

Input	Input image sequence
Output	Resulting image sequence
Shape	Shape used 1 - cross 2 - cube 3 - cube cross
Count	Number of recursive operations
Grey Morphology	0 - Distinguish between 0 and non 0 only 1 - All grey value shades are taken into account

Morphology - Close

This function carries out a closing.

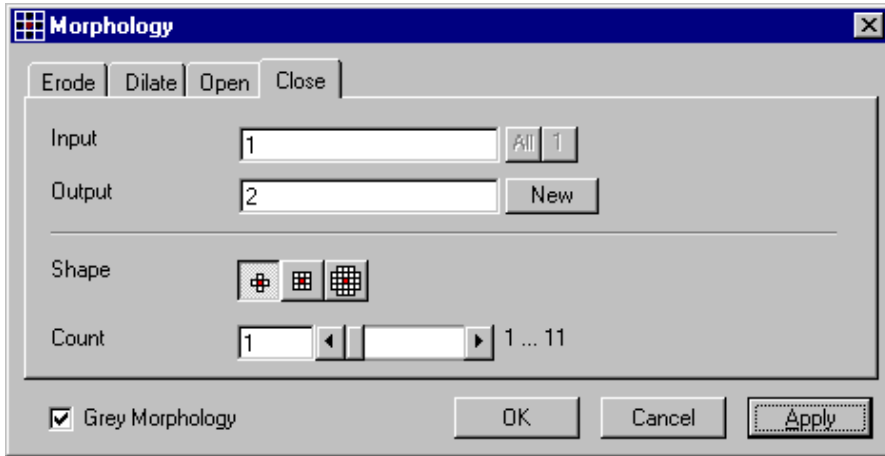


Fig. 23

In the **Morphology** dialog window, the tab sheet **Close** must be selected.

This function carries out a dilation followed by an erosion. For the most part, the closing maintains the original size of the regions. Connections are formed between adjacent regions; gaps and bright concave bulges in the contours of regions are filled in. The closing is applied **Count** times to the grey value image sequence Input with the shape **Shape**. If **Input** is a multichannel sequence any number and combination of channels can be selected. **Output** will only get the selected channels as results.

The **Count** scroll bar determines the number of recursive operations.

The following shapes (numbered 1 to 3 from left to right) are available:



If **Grey Morphology** is selected the function will respect all grey value shades of the sequence **Input**. If **Grey Morphology** is not selected the function will distinguish between 0 and non-0 only. The result **Output** will be a binary sequence.

Parameters:

Input	Input image sequence
Output	Resulting image sequence
Shape	Shape used 1 - cross 2 - cube 3 - cube cross
Count	Number of recursive operations
Grey Morphology	0 - Distinguish between 0 and non 0 only 1 - All grey value shades are taken into account

Segment - Interactive

This function carries out a grey value segmentation by means of thresholding.

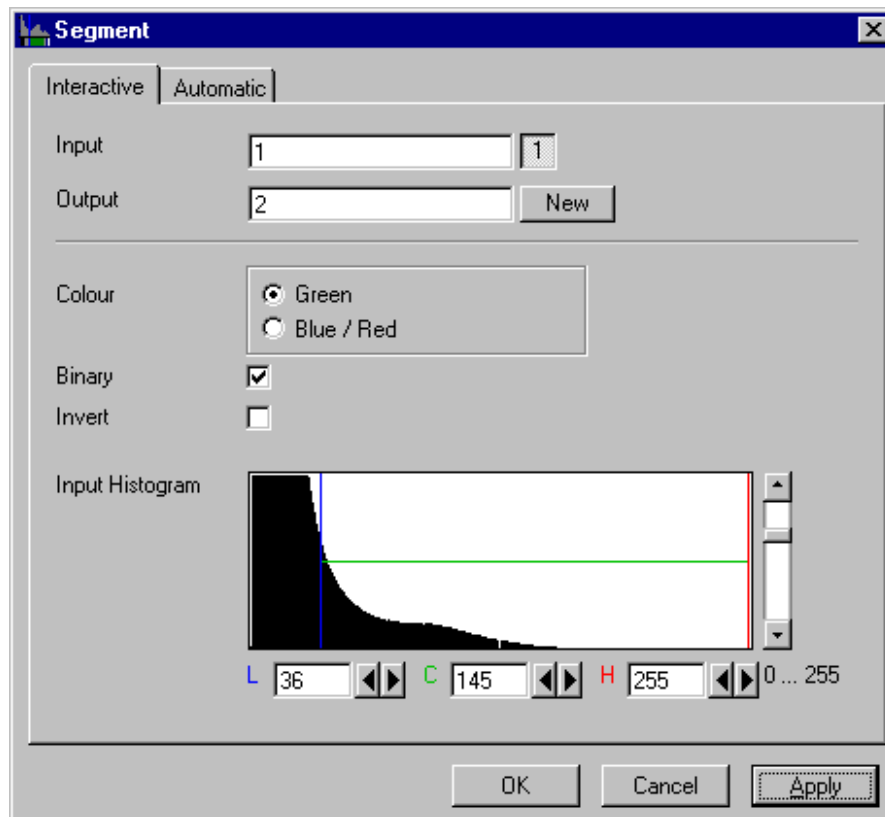


Fig. 24

The **Interactive** tab sheet of **Segment** dialog window must be selected.

Segmentation is especially used to generate binary regions. These are required for the measurement.

Two threshold values determine which grey value range of the **Input** image sequence is preserved and/or deleted in the **Output** image sequence. Only one channel of a multichannel sequence can be selected as **Input**. **Output** will always be a single channel sequence.

The vertical scaling of the histogram can be adjusted with the scroll bar at the right edge of the histogram. This setting has no influence on the function.

The thresholds **Low** and **High** are determined either by moving the borderlines in the grey value histogram or by the scroll bars underneath. Furthermore, the values for **Low**, **Center** and **High** can be set through entry in the corresponding fields.

To move the lower (**L**) and upper (**H**) thresholds at the same time, move the vertical line in the grey value histogram or set the scroll bar (**C**).

The **Green** and **Blue/Red** option buttons of the parameter **Colour** determine whether the voxels within (**Green**) or outside (**Blue/Red**) of the grey value interval [**L**, **H**] are displayed with the corresponding colour.

If **Green** is selected, the voxels within the selected interval are highlighted in green. The rest of the image retains its original grey values. The voxels with the grey values **Low** and **Low+1** are displayed in blue. The voxels with the grey values **High** and **High-1** are displayed in red.

If **Blue/Red** is selected, the voxels with grey values within the interval **Low**, **High** remain unchanged. Voxels with grey values less than **Low** are highlighted in blue; those with grey values higher than **High** are highlighted in red.

If the **Invert** option is selected, the grey values outside the defined interval will be segmented.

If the option **Binary** is selected, then all grey values in the range from **Low** to **High** will be set to white (grey value 255) in the **Output** image sequence, while all others will be set to black (grey value 0). If the option is not selected, the grey values within the selected interval remain unchanged, while those outside the range will be set to black. The measurement function accepts both results without any difference in the results.

Parameters:

Input	Input image sequence
Output	Resulting image sequence
Colour	Green - Selected interval is displayed in green
Blue/Red	Grey values below the selected interval are displayed in blue, grey values above in red
Binary	0 - Selected voxels retain the original grey value 1 - Selected voxels are set to grey value 255, the rest to grey value 0
Invert	0 - Grey values inside the selected interval are segmented 1 - Grey values outside the selected interval are segmented
L	Low grey value threshold
C	Center of threshold interval
H	High grey value threshold

Segment - Automatic

The function carries out an automatic grey value segmentation by means of thresholding.

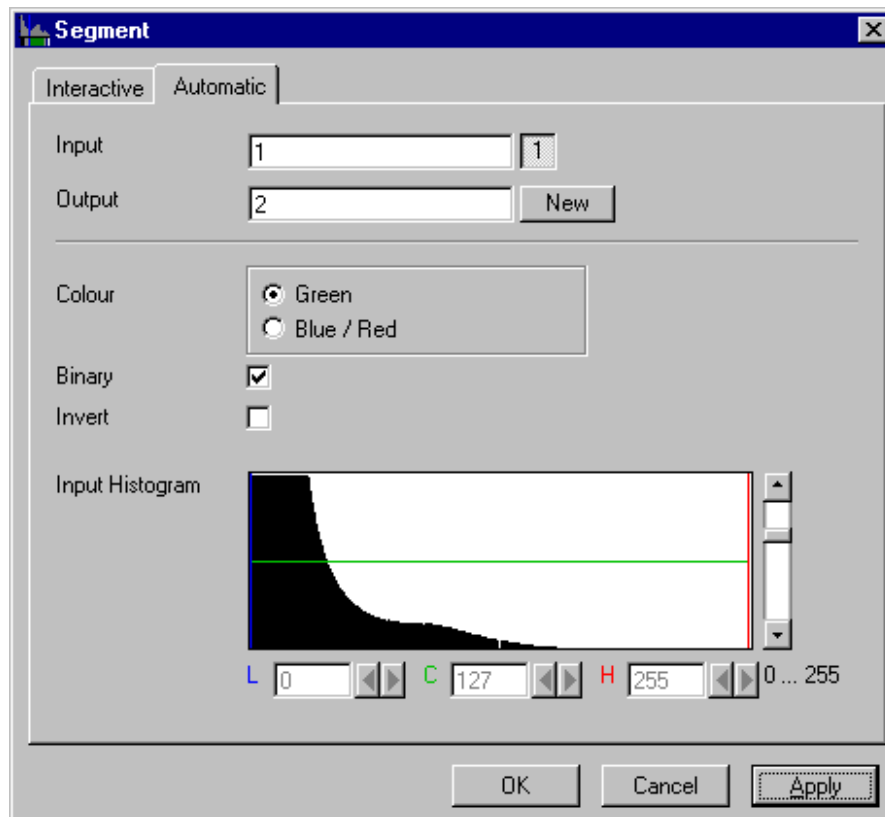


Fig. 25

The **Automatic** tab sheet of the **Segment** dialog window must be selected. Segmentation is especially used to generate binary regions. These are required for the measurement.

The function calculates the two strongest local minimums in the histogram of the **Input** image sequence. These values are used for the discrimination. Only one channel of a multichannel sequence can be selected as **Input**. **Output** will always be a single channel sequence. The vertical scaling of the histogram can be adjusted with the scroll bar at the right edge of the histogram. This setting has no influence on the function.

The **Green** and **Blue/Red** option buttons of the parameter **Colour** determine whether the voxels within (**Green**) or outside (**Blue/Red**) of the grey value interval [**L**, **H**] are displayed with the corresponding colour.

If **Green** is selected, the voxels within the selected interval are highlighted in green. The rest of the image retains its original grey values. The voxels with the grey values **Low** and **Low+1** are displayed in blue. The voxels with the grey values **High** and **High-1** are displayed in red.

If **Blue/Red** is selected, the voxels with grey values within the interval **Low**, **High** remain unchanged. Voxels with grey values less than **Low** are highlighted in blue; those with grey values higher than **High** are highlighted in red.

If the **Invert** option is selected, the grey values outside the defined interval will be segmented.

If the option **Binary** is selected, then all grey values in the range from **Low** to **High** will be set to white (grey value 255 (4095)) in the **Output** image sequence, while all others will be set to black (grey value 0). If the option is not selected, the grey values within the selected interval remain unchanged, while those outside the range will be set to black.

Parameters:

Input	Input image sequence
Output	Resulting image sequence
Colour	Green - Selected interval is displayed in green Blue/Red - Grey values below the selected interval are displayed in blue, grey values above in red
Binary	0 - Selected voxels retain the original grey value 1 - Selected voxels are set to grey value 255 (4095), the rest to grey value 0
Invert	0 - Grey values inside the selected interval are segmented 1 - Grey values outside the selected interval are segmented
L	Low grey value threshold
C	Center of threshold interval
H	High grey value threshold

Boolean - And

This function carries out a bit-by-bit **And** calculation for the image sequences **Input 1** and **Input 2**.

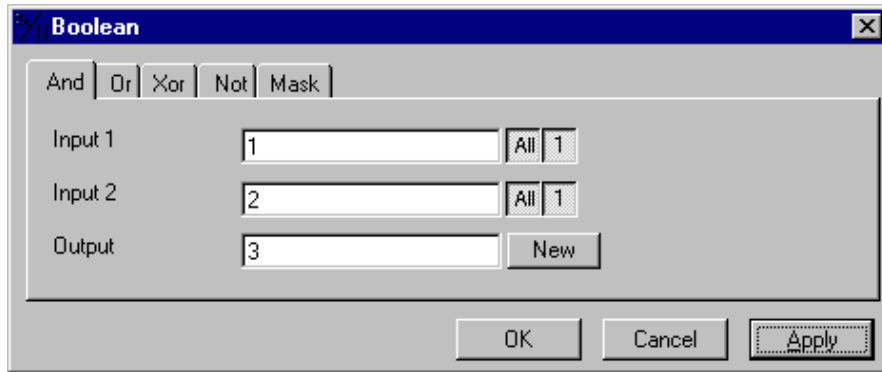


Fig. 26

The **And** tab sheet of the **Boolean** dialog window must be selected.

This function is especially well suited for masking images.

If one or both input sequences are multichannel sequences, any number or combination can be selected. The number of selected channels for **Input 1** and **Input 2** must be the same. They will be combined from left to right.

Parameters:

- Input 1** First input image sequence
- Input 2** Second input image sequence
- Output** Resulting image sequence

Boolean - Or

This function carries out a bit-by-bit **Or** calculation for the images **Input 1** and **Input 2**.

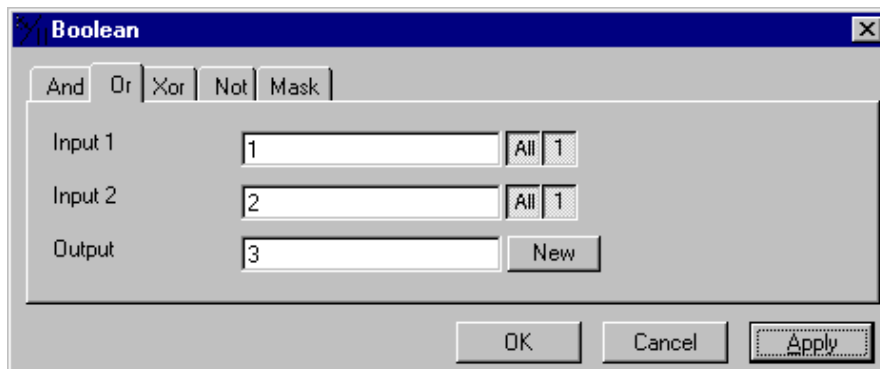


Fig. 27

The **Or** tab sheet of the **Boolean** dialog window must be selected.

This function can be used to combine binary masks or regions.

If one or both input sequences are multichannel sequences, any number or combination can be selected. The number of selected channels for **Input 1** and **Input 2** must be the same. They will be combined from left to right.

Parameters:

Input 1	First input image sequence
Input 2	Second input image sequence
Output	Resulting image sequence

Boolean - Xor

This function carries out a bit-by-bit **Xor** calculation for the images **Input 1** and **Input 2**.

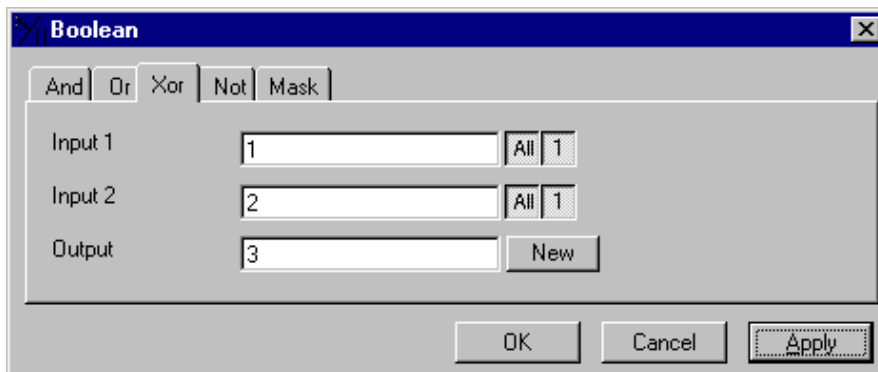


Fig. 28

The **Xor** option button of the **Function** option group in the **Boolean** dialog window must be selected.

This function can be used to combine binary masks or regions.

If one or both input sequences are multichannel sequences, any number or combination can be selected. The number of selected channels for **Input 1** and **Input 2** must be the same. They will be combined from left to right.

Parameters:

Input 1	First input image sequence
Input 2	Second input image sequence
Output	Resulting image sequence

Boolean - Not

This function carries out a bit-by-bit negation of an image.

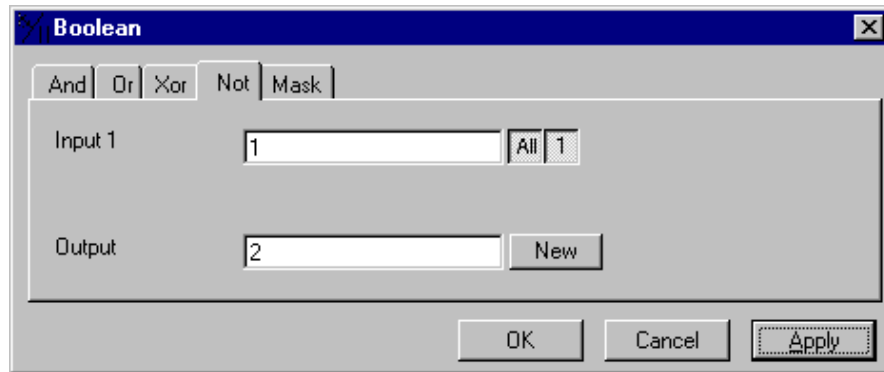


Fig. 29

The **Not** tab sheet of the **Boolean** dialog window must be selected.

If **Input** is a multichannel sequence any number or combination can be selected.

Parameters:

Input	Input image sequence
Output	Resulting image sequence

Boolean - Mask

This function masks a grey value image sequence.

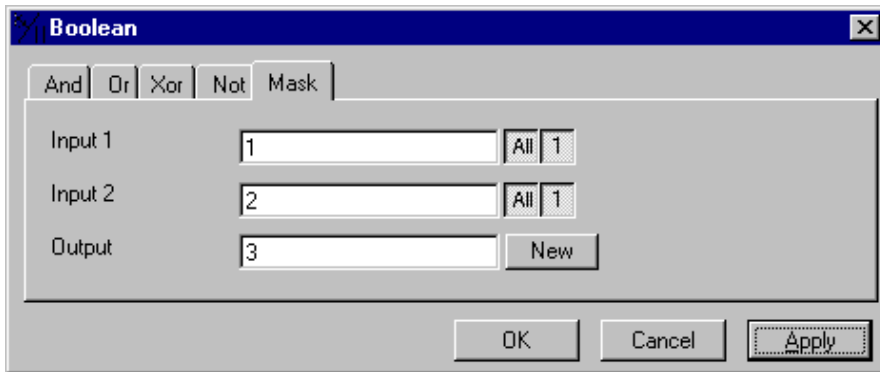


Fig. 30

The **Mask** tab sheet of the **Boolean** dialog window must be selected.

This function modifies the **Output** image sequence depending on the mask image sequence used.

If the grey value in **Input 2** is higher than 0, then the voxel values are copied from **Input 1** to the image sequence **Output**. If the grey value of the voxel is 0, then the voxel value of the **Output** image sequence is taken over.

If one or both input sequences are multichannel sequences, any number or combination can be selected. The number of selected channels for **Input 2** must be 1 or the same as for **Input 1**. They will be combined from left to right.

Parameters:

Input 1	First input image sequence
Input 2	Second input image sequence
Output	Resulting image sequence

Scrap

This function deletes or selects objects in a specified size range.

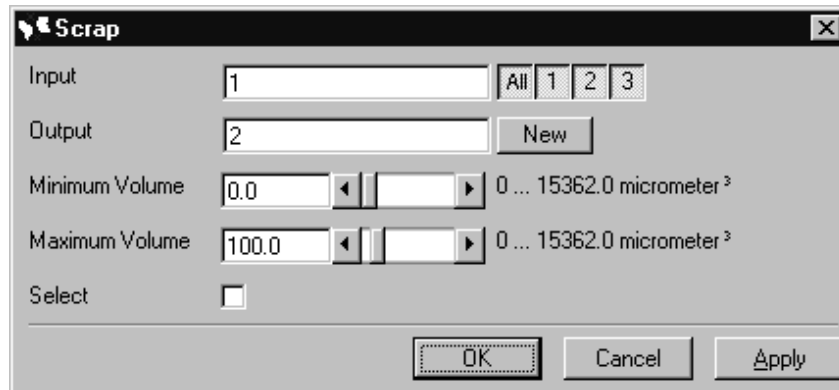


Fig. 31

The operation deletes or selects objects on the basis of their total volume in voxels. Objects with a volume within the range **MinVolume** to **MaxVolume** are effected.

To delete objects outside the range, the parameter **Select** must be active. If the parameter is not activated objects outside the defined volume range are deleted.

Parameters:

Input	Input image sequence
Output	Output image sequence
MinVolume	Minimum object size
MaxVolume	Maximum object size
Select	0 - Select the objects outside the size range 1 - Select the regions within the size range

Fill Holes

This function fills holes in all objects.

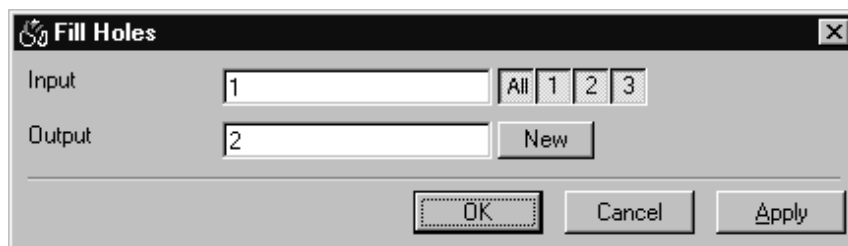


Fig. 32

All holes in objects are filled by this operation. Holes are structures, which have a grey value of 0 and are surrounded completely by voxels with a grey value not equal to 0. It is assumed that regions outside the image are black. Holes, which touch the image border, are retained.

Parameters:

Input	Input image sequence
Output	Output image sequence

6.1.3.4 Functions in the View Menu

Render - Surface

This function displays an image sequence according to the **gradient shading method**.

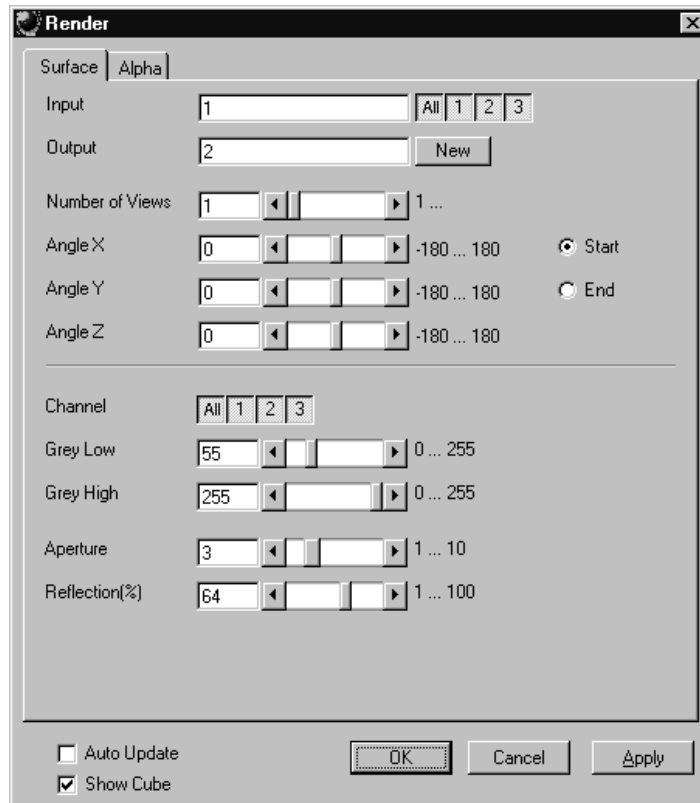


Fig. 33

The **Surface** tab sheet of the **Render** dialog window must be selected.

Method

The **Input** sequence defines the data to be reconstructed. If it is a multichannel sequence one or all channels can be selected for the reconstruction.

Output sets the name of the result image (sequence). If the sequence exists it is overwritten. Pressing the button **New** will generate a new name (number). The size of the sequential images in **Output** is determined by the size of the sequential images in **Input**.

Number of Views determines the number of reconstructions which should be computed. The radio buttons **Start** and **End** define which angle settings are currently shown. A definition for the angle **End** is only necessary if **Number of Views** is higher than 1. If this is true the result sequence will get views from the **Start** to the **End** angle definition. The other reconstructions are determined through the linearly interpolated intermediate angles. The direction of view is determined from the angles as follows:

The angle **Angle Z** determines the rotation of the direction of view on the Z-axis. The angle **Angle Y** determines the rotation of the direction of view on the Y-axis that has been rotated by the angle **Angle Z**. The angle **Angle X** determines the rotation of the direction of view on an X-axis that is rotated by **Angle Z** and **Angle Y**.

Channel defines if the following parameters are valid for **All** or just for one. Defining the thresholds for the channels independently is useful if the grey value boundaries of the objects differ too much in the different channels. The thresholds **Grey Low** and **Grey High** define the grey value range of the objects.

The parameter **Aperture** is a measure of the size of the highlights. Small values generate large highlights. Large values generate small highlights (similar to a spot).

Use the parameter **Reflection** to control the ratio of diffuse and reflective brightness components, i.e., the overall basic brightness compared with the highlights. When the value of **Reflection** is low, the highlights predominate; when the values are high, the region appears to be uniformly illuminated and the highlights are not so pronounced. When **Auto Update** is selected, the reconstruction is updated automatically whenever a parameter is modified (except **Input**, **Output**, or **Number of Views**). **Show Cube** defines whether a wire frame cube is shown in the **Display window** or not.

Application

This method can be applied, if the structures in the **Input** sequence can be segmented by grey value thresholding. Because the gradient is calculated for every pixel, the **Output** appears in very fine detail.

Noisy **Input** sequences must be smoothed (function **Smooth**) before rendering, otherwise the surface appears rough.

Parameters:

Input	Input image sequence
Output	Resulting image sequence
Number of Views	Number of reconstructions to be calculated
Angle X	Angle of rotation on the X-axis, start position
Angle Y	Angle of rotation on the Y-axis, start position
Angle Z	Angle of rotation on the Z-axis, start position
Channel	All - The following parameters are valid for all channels X - The following parameters are valid for the selected channel only
Grey Low	Low grey value threshold of the region to be displayed

Grey High	High grey value threshold of the region to be displayed
Aperture	Measure of the extent of the highlights
Reflection	Weight of the diffuse brightness components in comparison to the highlights
Auto Update	0 - Function execution is performed on OK or Apply 1 - Function execution for the current angle is performed on any parameter change
Show Cube	0 - The wire frame cube is not shown 1 - The wire frame cube is shown in the Display window

Render - Surface: Method Description

This method displays the surface of structures in the **Input** sequence shaded as if a light illuminated it. The position of the light is behind the view point with parallel rays in the direction of the sequence.

The input sequence is segmented into object and background by grey value thresholding: object voxels are within the grey value range **Grey Low** to **Grey High**.

Each **Output** pixel corresponds to a point at the surface at which the ray in view direction through the **Output** pixels hits the surface. All rays are parallel.

The surface normal required for shading in this gradient renderer is the grey value gradient in the **Input** volume at the surface voxel position. It is not the geometric surface normal. The grey value gradient is determined from the grey values in a 3x3x3 cube around the surface voxel by averaging e.g. the x-gradient in y- and z-direction [4].

There is no depth cueing (far objects would appear darker).

The illumination model is a Phong model [1] (surface normal is determined for each **Output** pixel) with diffuse reflection and specular reflection. Diffuse reflection means that the surface reflects light with equal intensity in all directions. The brightness of a given surface patch depends not on the view-direction, but only on the angle between light and surface normal. Specular reflection is observed on shiny surfaces as a highlight. The light is reflected as from a mirror. The maximum intensity is observed when the view direction is the one of the mirrored light direction.

Render - Alpha

This function displays an image sequence according to the **alpha rendering method**.

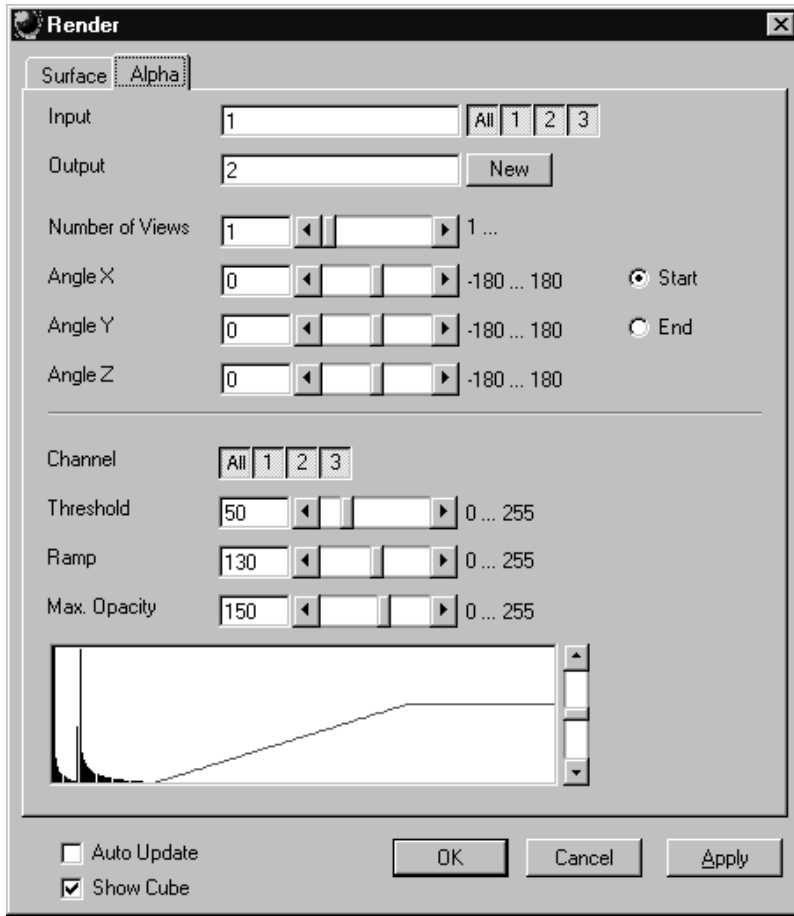


Fig. 34

The **Alpha** tab sheet of the **Render** dialog window must be selected.

One or more reconstructions of the input image sequence are computed according to the alpha rendering method. This type of reconstruction should be used if there is no possibility to segment the structures in the image sequence and also if the objective is to make deeply layered structures visible.

Method

The **Input** sequence defines the data to be reconstructed. If it is a multichannel sequence one or all channels can be selected for the reconstruction.

Output sets the name of the result image (sequence). If the sequence exists it is overwritten. Pressing the button **New** will generate a new name (number). The size of the sequential images in **Output** is determined by the size of the sequential images in **Input**.

Number of Views determines the number of reconstructions which should be computed. The radio buttons **Start** and **End** define which angle settings are currently shown. A definition for the angle **End** is only necessary if **Number of Views** is higher than 1. If this is true the result sequence will get views from the **Start** to the **End** angle definition. The other reconstructions are determined through the linearly interpolated intermediate angles.

The direction of view is determined from the angles as follows:

The angle **Angle Z** determines the rotation of the direction of view on the Z-axis. The angle **Angle Y** determines the rotation of the direction of view on the Y-axis that has been rotated by the angle **Angle Z**. The angle **Angle X** determines the rotation of the direction of view on an X-axis that is rotated by **Angle Z** and **Angle Y**.

Channel defines if the following parameters are valid for **All** or just for one. Defining the opacity for the channels independently is useful when the brightness and contrast of the channels differ too much. **Threshold** defines the range with no opacity. It is completely transparent. The range starts at grey value 0.

The length of slope is defined by **Ramp**. The maximum opacity value is set with the parameter **Max. Opacity**. This range ends at the maximum grey value. The **Opacity Table** shows the grey value histogram of Input with the opacity definition as a red line.

When **Auto Update** is selected, the reconstruction is updated automatically whenever a parameter is modified (except **Input**, **Output**, or **Number of Views**). **Show Cube** defines whether a wire frame cube is shown in the **Display window** or not.

Application

1. This method can be applied, if the structures in the Input sequence are unsharp so that objects are poorly defined by their grey value.
2. In this case, the Opacity Table is defined as a ramp. Low grey values have weight 0 to suppress the background voxels. The opacity rises with increasing grey values, depending on the parameter Ramp. The value of Max. Opacity defines the weight of the high grey values. High grey values above a threshold have weight 255 to show the "object" voxels unsuppressed. Of course a smooth step can be used.
3. The result is a display with inside structures shining through. A 3D impression can be obtained by rendering with several view directions.
4. In contrast to this, a voxel renderer like the gradient renderer would display only the surface of objects that are defined by grey value-thresholds. This surface would appear shaded as if illuminated by a light.
5. The method can also be applied to visualize pronounced structures within other enclosing structures, if the structures have different grey value ranges.
6. In this case, the Opacity Table is defined as a step. Low grey values (background) have weight 0. High grey values (inside structures) have maximum weight.

Parameters:

Input	Input image sequence
Output	Resulting image sequence
Number of Views	Number of reconstructions to be calculated
Angle X	Angle of rotation on the X-axis, start position
Angle Y	Angle of rotation on the Y-axis, start position
Angle Z	Angle of rotation on the Z-axis, start position
Channel	All - The following parameters are valid for all channels X - The following parameters are valid for the selected channel only
Threshold	Grey value where the opacity starts rising
Ramp	Length of the opacity slope
Max. Opacity	Maximum opacity value
Opacity Table	Maximum opacity value
Auto Update	0 - Function execution is performed on OK or Apply 1 - Function execution is performed on any parameter change
Show Cube	0 - The wire frame cube is not shown 1 - The wire frame cube is shown in the Display window

Render - Alpha: Method Description

Each **Output** pixel is a weighted sum of the **Input** voxels along a ray in view direction through the **Input** sequence. Each **Input** voxel has an opacity value, dependent only on its grey value. The opacity values are defined by the parameters **Threshold**, **Ramp**, and **Max. Opacity**.

Accumulation of pixels proceeds along the ray from back to front, i.e. from far pixels to near pixels. If a new pixel is added, it increases the result intensity by its grey value weighted by the opacity value, and attenuates the previously accumulated intensity according to the opacity value. Full intensity stops accumulation.

This calculation must be repeated for each pixel of the ray to generate one **Output** pixel. Then for each **Output** pixel to produce a 2D **Output** image for the selected view-angle. Then for each view-angle to produce an output sequence for **Number of Views** different view angles.

Render - References

- [1] J.D. Foley, A. van Dam, S. K. Feiner, J.F. Hughes, Computer Graphics: Principles and Practice, Addison Wesley, Reading, MA, 1990.
- [2] M. Levoy, Display of Surfaces from Volume Data, IEEE Computer Graphics & Applications, May 1988, 29-37.
- [3] J. Ylä-Jääski, F. Klein, O. Kübler, Fast Direct Display of Volume Data for Medical Diagnosis, VGIP: Graphical Models and Image Processing 53, 1991, 7-18.
- [4] K.H. Höhne, R. Bernstein, Shading 3D-Images from CT Using Gray-Level Gradients, IEEE Transactions on Medical Imaging, 5, 1986, 45-47.
- [5] D. Gordon, R.A. Reynolds, Image Space Shading of 3-Dimensional Objects, CVGIP 29, 1985, 361-376.

6.1.3.5 Functions in the Measurement Menu

Measurement Concept

Measurement is based on regions (objects) in three-dimensional space. Segmenting an image sequence generates these. The image segmentation process produces a mask image that defines the region.

A region is a group of voxels that touch at the surfaces or at the edges, but not at the corners (18 voxel neighborhood).

This is illustrated by the following example. The voxels marked black in sequential image Z-1, Z, Z+1 all belong to the same region as the grey central voxel in sequential image Z. The volume view shows the neighborhood interrelationships as a 3D projection.

Sequential image:

Volume view:

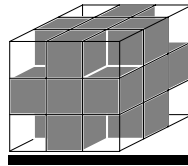
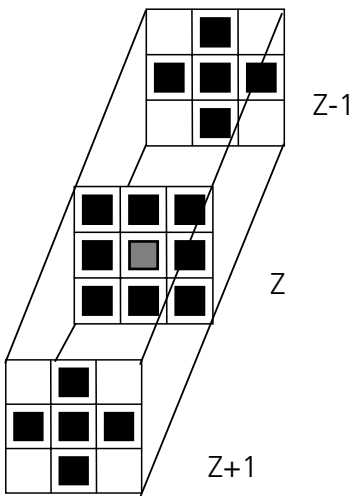


Fig. 35

Measurement Process

The measurement process consists of three steps: region definition, checking of the validity of the regions, and feature calculation.

- | | |
|-------------------------------------|---|
| Region definition: | - Automatically from the mask image |
| Region validation check depends on: | - Minimum volume
- Measurement condition |
| Feature calculation depends on | - Shape of the region
- Densitometric value distribution of the region
- Feature parameters |

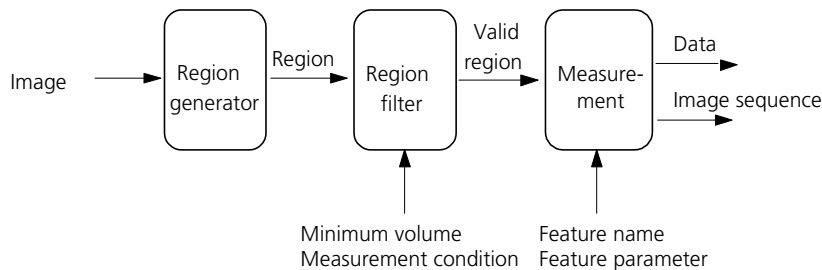


Fig. 36

All regions found are checked according to certain conditions. The voxel volume of each region must be equal to or greater than **MinVolume**. The measurement condition must be fulfilled. Only those regions that meet all the conditions are valid for the measurement. The region can be measured or labeled. Measurement is a process that produces data. Labeling is a process that generates an image volume.

Automatic Object Measurement – Object Features

A measurement feature describes a region characterized by a number (e.g. volume, area or a densitometrical statistic). The features can be selected on the **Object Features** and **Volume Features** tab sheets.

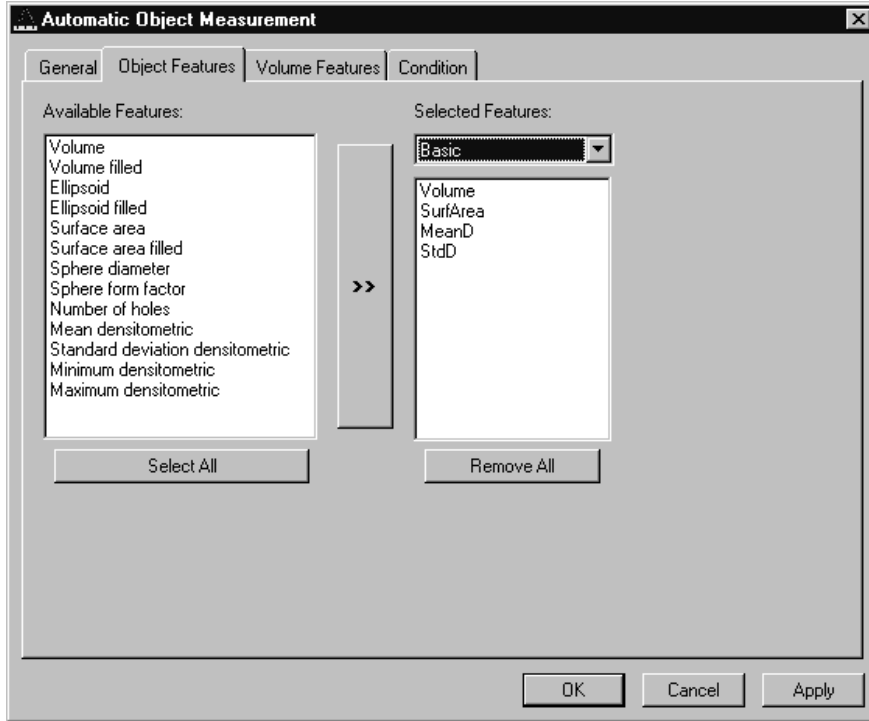


Fig. 37

The scalings and units are taken automatically from the assigned sequence.

The measurement features can be selected individually for each measurement. The object features generate a result value for every single object.

The dialog shows two lists. One shows the **Available Features** as groups (on the left). The other one shows the **Selected Features**. Double-clicking on items of the left list will add the **Selected Features** to the right list. Double-clicking on an item of the right list will remove this item from the list. **Selected Features** can also be transferred by clicking on the button in the middle (<< / >>) of the dialog.

The combo box above the right list represents predefined feature lists. Selecting one of the entries will fill the right list with these features; previously selected features will be overwritten.

The button **Select All** will copy all features to the list of selected features.

The button **Remove All** will clear the list of selected features.

Clicking on the **Apply** button will execute the measurement process and switch to the **General** tab sheet of the dialog.

Parameters:

Available Features	List of available object features
Selected Features	List of selected object features
Select All	Select all available object features for measurement
Remove All	Remove all object features from the selected features list

The following sections describe all measurement features which are defined in the system.

Object Features (geometric)

If **Object Features** are selected, one set of measurement data is calculated for each object.

Group Name	Name	Description
Volume	Volume	Volume of the object.
Volume Filled	VolumeF	Volume of the filled object.
Ellipsoid	EllipseA	Length of the main axis of the ellipsoid with the same geometrical moment of inertia as the object.
	EllipseB	Length of the middle axis of the ellipsoid with the same geometrical moment of inertia as the object.
	EllipseC	Length of the minor axis of the ellipsoid with the same geometrical moment of inertia as the object.
Ellipsoid filled	EllipseAF	Length of the main axis of the ellipse with the same geometric moment of inertia as the filled object.
	EllipseBF	Length of the middle axis of the ellipse with the same geometric moment of inertia as the filled object.
	EllipseCF	Length of the minor axis of the ellipse with the same geometric moment of inertia as the filled object.
Surface Area	SurfArea	Surface area of the object.
Surface Area Filled	SurfAreaF	Surface area of the filled object.
Sphere Diameter	Dsphere	Diameter of the sphere with the same volume. $\sqrt{6 * \text{VOLUMEF} / \pi}$
Sphere Form Factor	Fsphere	Form factor of the object. $6 \cdot \sqrt{\pi} \cdot \frac{\text{VOLUMEF}}{\sqrt{\text{SURFAREA}^3}}$
Number of Holes	Nparts	Number of holes within an object.

Object Features (densitometric)

Group Name	Name	Description
Mean Densitometric	MeanD	Densitometric mean value of an object.
Standard Deviation Densitometric	StdD	Standard deviation of the densitometric values of an object.
Minimum Densitometric	MinD	Minimum grey value of an object.
Maximum Densitometric	MaxD	Maximum grey value of an object.

Automatic Object Measurement - Volume Features

A measurement feature describes a region characterized by a number (e.g. volume, area, or a densitometrical statistic). The features can be selected on the **Object Features** and **Volume Features** tab sheets.

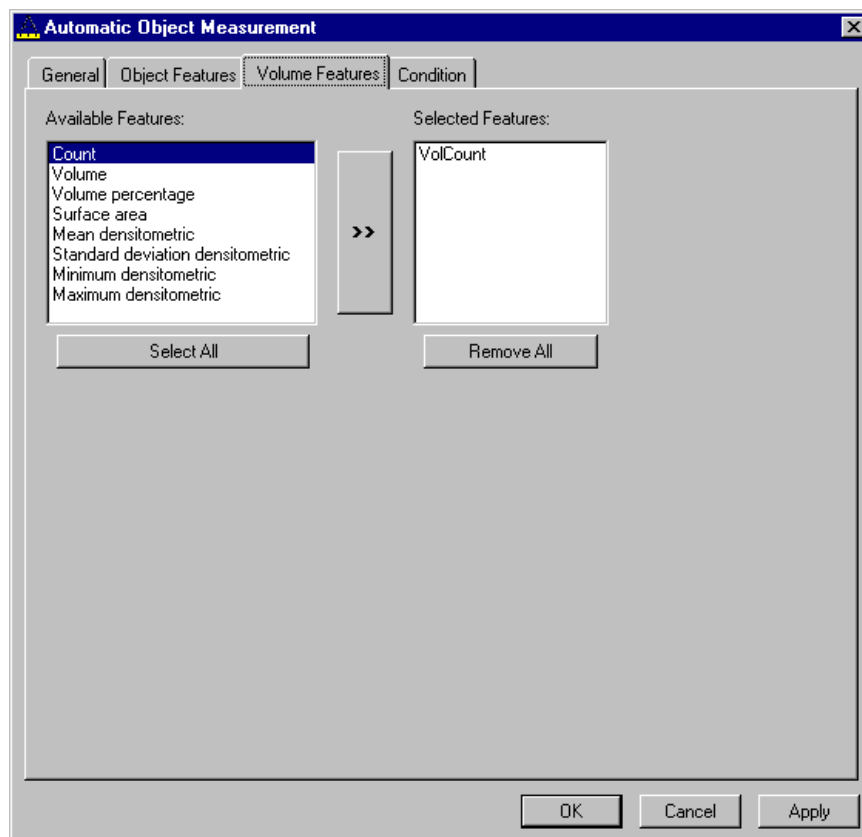


Fig. 38

The measurement features can be selected individually for each measurement. The object features generate a result value for every single object.

The dialog shows two lists. One shows the **Available Features** as groups (on the left). The other one shows the **Selected Features**. Double-clicking on items of the left list will add the **Selected Features** to the right list. Double-clicking on an item of the right list will remove this item from the list. **Selected Features** can also be transferred by clicking on the button in the middle (<< / >>) of the dialog.

The combo box above the right list represents predefined feature lists. Selecting one of the entries will fill the right list with these features; previously selected features will be overwritten.

The button **Select All** will copy all features to the list of selected features.

The button **Remove All** will clear the list of selected features.

Clicking on the **Apply** button will execute the measurement process and switch to the **General** tab sheet of the dialog.

Parameters:

Available Features	List of available object features
Selected Features	List of selected object features
Select All	Select all available object features for measurement
Remove All	Remove all object features from the selected features list

Volume Features (geometric)

The volume-related measurement generates one measured value per image sequence. The following table contains the predefined volume characteristics.

Group Name	Name	Description
Count	VolCount	Number of regions measured.
Volume	VolVolume	Total volume of all regions.
Volume Percentage	VolVolumeP	Total volume of all regions, in relation to the volume of the image sequence.

Volume Features (densitometric)

Group Name	Name	Description
Surface Area	VolSurfArea	Total surface area of all regions.
Mean Densitometric	VolMeanD	Mean grey value of all regions.
Standard Deviation Densitometric	VolStdD	Grey value standard deviation of all regions.
Minimum Densitometric	VolMinD	Minimum grey value in the image sequence.
Maximum Densitometric	VolMaxD	Maximum grey value in the image sequence.

Automatic Object Measurement - Condition

The measurement conditions are used to limit the objects to be evaluated (e.g. only objects with defined minimum value). All objects are tested against the defined conditions. If the conditions are fulfilled the feature values are written to the data table.

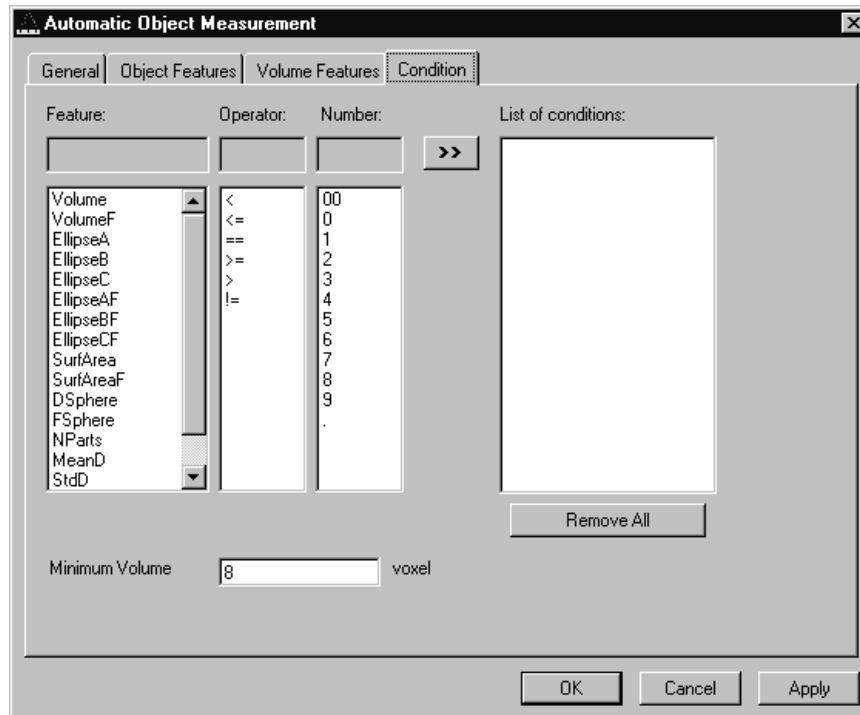


Fig. 39

To define the following parameter select the **Condition** tab sheet of the **Automatic Object Measurement** dialog window.

The list on the very left at the dialog shows all the measurement **Features**. The second list provides the comparison **Operators** and the next **Numbers** to define a value. This gives the possibility to compose an expression to test a feature value against a constant value. The fields above the lists will show the composed (selected) string. Clicking on the desired list entry does the selection. The button with the „>>“ characters adds this string to the **List of Conditions**. All lines of the **List of conditions** are combined with the AND expression automatically. To remove a condition line double-click on it.

The parameter **Minimum Volume** defines the minimum voxel volume for the measurement. This is an easy way to eliminate very small regions caused by noisy sequences and segmentation process.

The button **Remove All** will clear the list of defined conditions.

Clicking on the **Apply** button will execute the measurement process and switch to the **General** tab sheet of the dialog.

Parameters:

Feature	List of available object features
Operator	List of available condition operators
Number	List of numbers to compose the value
List of conditions	Defined condition list
Remove All	Remove all entries from the List of conditions
Minimum Volume	Minimum object volume in voxel

Automatic Object Measurement - General

This function carries out an automatic measurement and labeling.

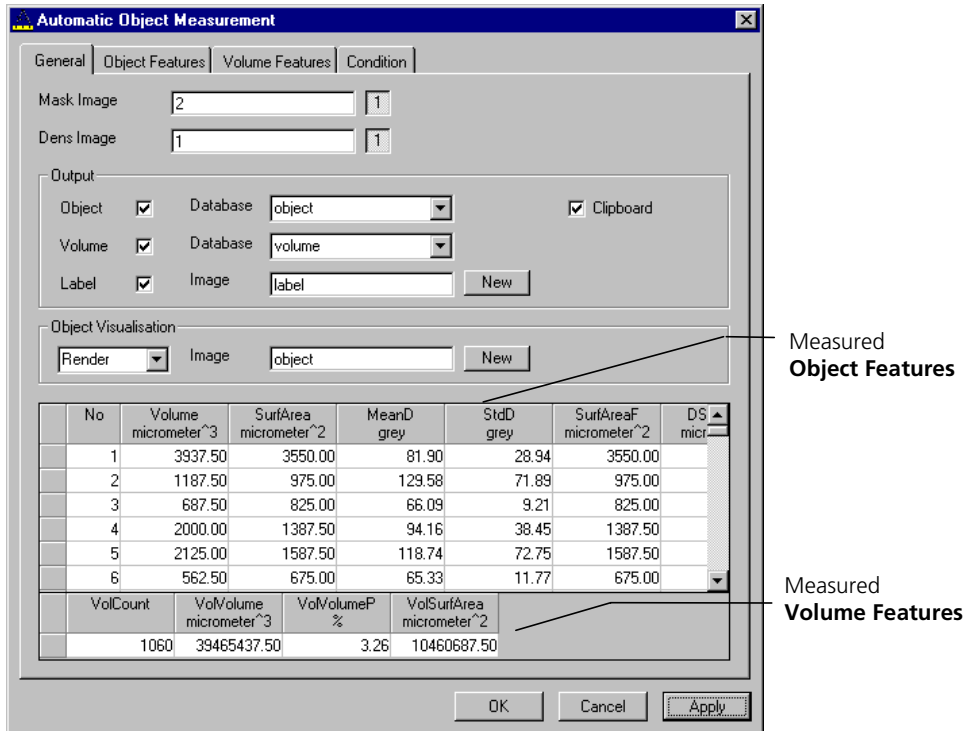


Fig. 40

The regions must be defined by an image sequence **Mask Image** (the objects must be separated from one another by black voxels with the grey value 0). This sequence is generated with the function **Segment**. If it is a multichannel sequence a single channel has to be chosen.

The image **Dens Image** is needed for the measurement of the densitometric features. Image sequence properties like scaling and unit are taken from **Dens Image**. A single channel of this sequence (if it is multichannel) must be selected with the buttons to the right of the parameter.

The measurement results can be stored to database files. These files are tab delimited ASCII files which can be easily imported to major Windows programs like text processing or spread sheet application. Writing database files are independently supported for object and volume features. Activating the corresponding check boxes enables it. The name of the database is defined with the field **Database**. The files will be located in the subdirectory DATA of the main installation directory. The filename extension TXT will be added automatically.

If the check box **Label** is activated a single channel sequence will be generated. It contains all the measured objects, each object is coloured homogeneous but in different colours. To copy all measurement values to the clipboard activate the check box **Clipboard**.

A single object of interest can be visualized. Clicking on a specific row in the data grid chooses the object. By selecting a row in the data grid a new image is created with the object of interest visualized. The visualization depends on the settings in the **Object Visualisation** field. If **Render** is chosen, the object of interest is displayed with the **Surface Rendering** method. If **Mask** is chosen, the object is labelled in a pseudo colour in a new image stack.


Parameters:

Mask Image	Single channel mask image sequence that defines the objects
Dens Image	Image sequence for densitometric measurement and property source
Object	Stores measurement values of objects, including database filename
Volume	Stores volume measurement values of objects, including database filename
Label	Generates an image sequence with all objects labelled in different pseudo colours
Clipboard	Measurement values are automatically written to the clipboard

6.2 Change Filters

The **Change Filters** tool is used to update the filter data in the software after a change of filters in the reflector turret.

- Close the ZEN software program.
- Insert the new filter module in the reflector turret.
- Double-click on the **Change Filters** icon on the desktop.
 - The **Emission Filter & Beam Splitter Control** window appears on the screen. The name of the currently used database is displayed in the **System Database** box, with the filter type being indicated below for checking purposes.
 - The **Filter Cubes Stand** panel shows the **Filter-Wheel No.** and the filter positions available.
 - Use the **Name** and **ID** selection boxes to enter the filters installed in the individual positions of the filter wheel.
- Open the **Name** (or **ID**) selection box of the relevant filter position and select the new filter set from the list.
- Click on the **Store** button to accept the new settings.
- Click on the **Close** button to close the **Emission Filter & Beam Splitter Control** window.

 All available filter sets have to be registered in the filter list (see **Edit Filter List** function, next page).

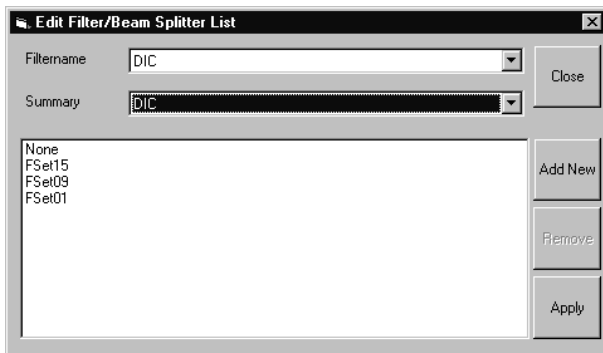


Fig. 41 Edit Filter/Beam Splitter List window

Edit Filter List

The **Edit Filter List** function permits updating of the filter data in the software after a change of filters on the stand.

- Close the ZEN software program.
- Double-click on the **Change Filters** icon on the desktop.
- Click on the **Edit Filter List** button in the **Emission Filter & Beam Splitter Control** window.
 - The **Edit Filter/Beam Splitter List** window is opened.

This window permits a list of the most frequently used filter sets to be compiled.

- Click on the arrow button in the **Filename** list box to open it.
- Select the filter set which shall be included in the list.
- Click on the **Apply** button.

The selected filter set is included and displayed in the list (below the **Summary** list box).

This filter set is now also available in the **Name** selection boxes of the **Filter Cubes Stand** panel and can be assigned to a filter wheel position.

To remove a filter set which is no longer needed from the list, proceed as follows:

- Click on the name of the filter set concerned in the list box of the **Edit Filter/Beam Splitter List** window.
- Click on the **Remove** button. The filter set is deleted from the list and is then no longer available in the **Filter Cubes Stand** panel of the **Emission Filter & Beam Splitter Control** window.


Add New

This function permits new filter sets to be added to the database.

For this, proceed as follows:

- Click on the **Add New** button on the **Edit Filter/Beam Splitter List** window.
 - The **Add New Filter/Beam Splitter** window is opened.
- Enter the data of the new filter set in the **Filter Cubes Stand Description** panel, then click on the **Apply** button.

The new filter set is stored in the database and included in the **New Filter Cubes Stand** panel. You can now activate the filter for a filter wheel position using the procedure described above.

 If you have activated the **Non Zeiss** check box, filter sets from other manufacturers can also be included in the database.

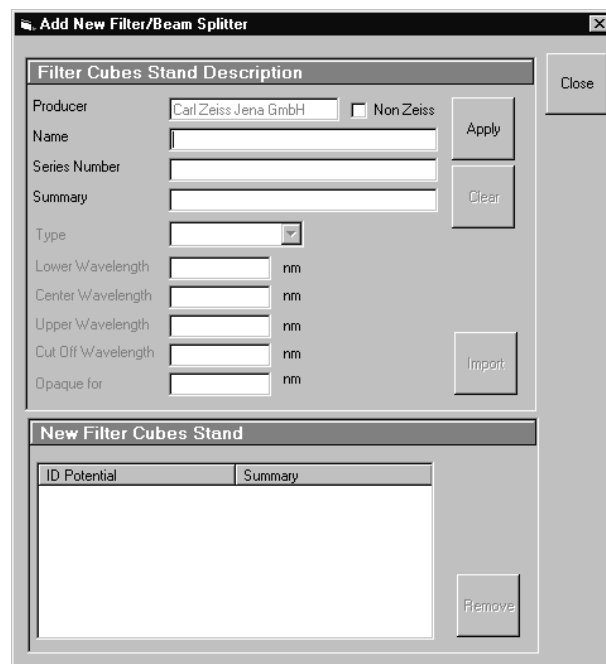


Fig. 42 Edit Filter/Beam Splitter List window

- To remove an new filter set from the database, select it with a click of the mouse in the **New Filter Cubes Stand** panel and then click on **Remove**.
- Click on **Close** to close the **Add New Filter/Beam Splitter** window.
- Click on **Close** to close the **Edit Filter/Beam Splitter** List window.
- Click on the **Store** button to accept the new settings.
- Click on the **Close** button to close the **Emission Filter & Beam Splitter Control** window.

When you start the ZEN software, the filter data are updated.

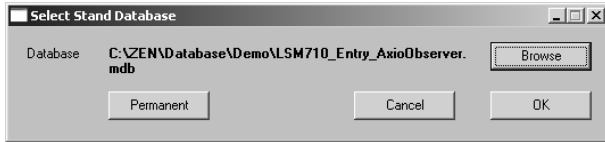


Fig. 43 Select Stand Database window

6.3 Stand Select

The **Stand Select** tool permits a new or updated database to be assigned to the ZEN software program. This function should preferably be performed by authorized service personnel.

If this is not possible, proceed as follows:

- Close the ZEN software program and double-click on the **Stand Select** icon on the desktop.
 - The **Select Stand Database** window appears on the screen. The currently used database is displayed in the **Database** box.

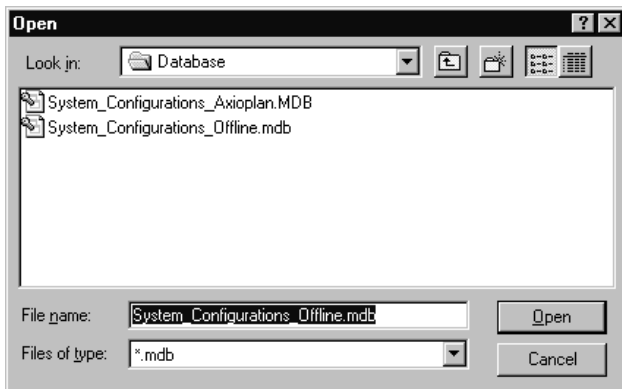


Fig. 44 Open window

- Click on the **Browse** button to activate the new database.
 - The **Open** window appears on the screen.

- Select the directory where the new database is stored.
- Click on the name of the database (file extension: ***.mdb**) and then on the **Open** button.
 - The **Open** window is closed and the name of the new database appears in the **Database** box.

- The **Open** window is closed and the name of the new database appears in the **Database** box.

- Click on the **Permanent** button. The **Select Name** window appears.

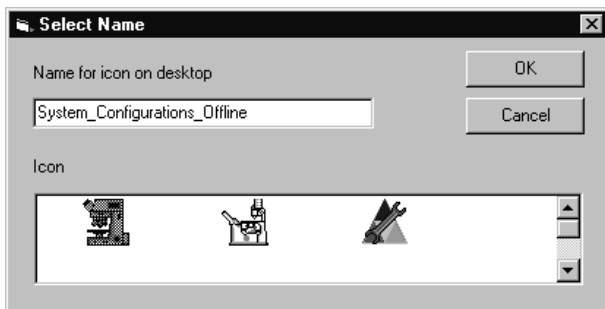


Fig. 45 Select Name window

- Select the relevant stand icon from the **Icon** list box and click on **OK**. The **Select Name** window is closed and the desktop icon is updated.

- Then click on the **OK** button in the **Select Stand Database** window to accept the new settings and to close the window. (Clicking on **Cancel** will cancel the procedure.)

- After the next restart of the ZEN software, the new database will be automatically loaded.

6.4 Maintenance Tool

With a calibration objective and correct system configuration, the maintenance tool allows convenient self adjustment of the LSM 710 and LSM 780 systems. The optical beampath, relative pinhole position and scanner adjustment can be set and checked automatically on the LSM 710 and LSM 780 systems.

6.4.1 Calibration objective

Observe the following notes:

- The calibration objective is not suitable for NLO, there is a risk of bubble formation in the substrate.
- Using the HAL, the IR protection filter must be used, and the intensity of the HAL should only briefly be set to more than 70 %.
- With strong heat there is a risk of deformation of the substrate in the calibration objective.
- The lateral screws need to be tightened carefully without applying too much force.
- The calibration objective needs to be entered in the system database as "APO Calibration LSM" with SAP no. 420639-9000-700. It needs to be entered at ZEN \ Maintain \ Objectives.
- Calibration objectives with other samples than shown in Fig. 46 shall not be used. The cap with the calibration sample can be obtained separately under SAP-No. 420639-9900-700.

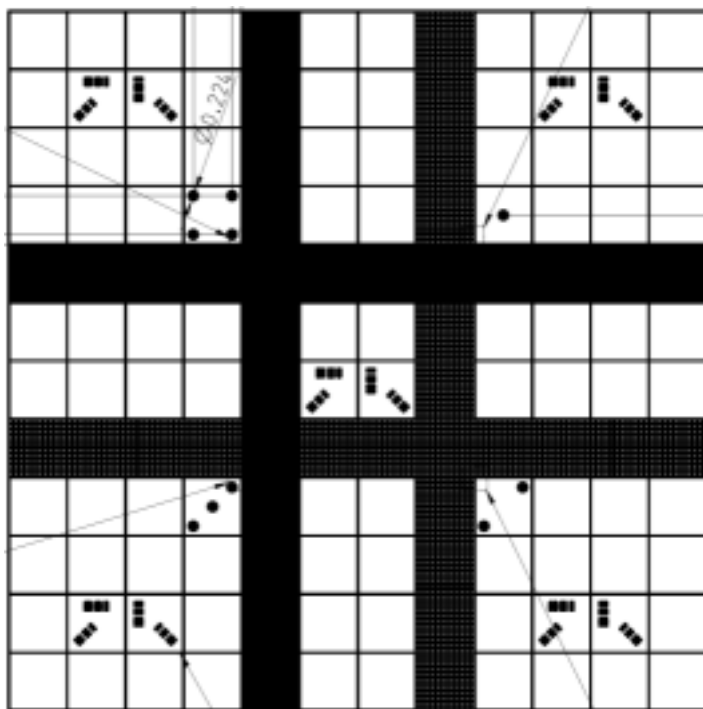


Fig. 46 Calibration objective

6.4.2 Starting the Maintenance Tool

Before starting the maintenance tool, the system hardware must be fully activated.

With ZEN 2010, check the following settings:


- Correct entry of all existing lenses; the calibration objective needs to be entered as "APO Calibration LSM".
- For systems with a 405 nm laser, an approximate collimator position should be saved for the calibration objective.
- The focus plane needs to be approximately correct
- All light sources (Hal, LED's, lasers) need to be activated
- After start, choose "Log in... Customer".

6.4.3 General operation of the Maintenance Tool

The desired task can be chosen from the list and started with the start button.

The calibration result is displayed with a traffic light type green/yellow/red indicator.

- If yellow is indicated, repeat the task and try to optimize the settings (e.g. check focus, KÖHLER lamps, lasers (no standby) etc.
- If red is indicated, repeat the test one more time; if it still fails, contact your local LSM service technician.

 On LSM 7 *DUO* systems, the maintenance tool calibrates only the components of the LSM 710 scanhead, not the LSM 7 *LIVE* scanhead.

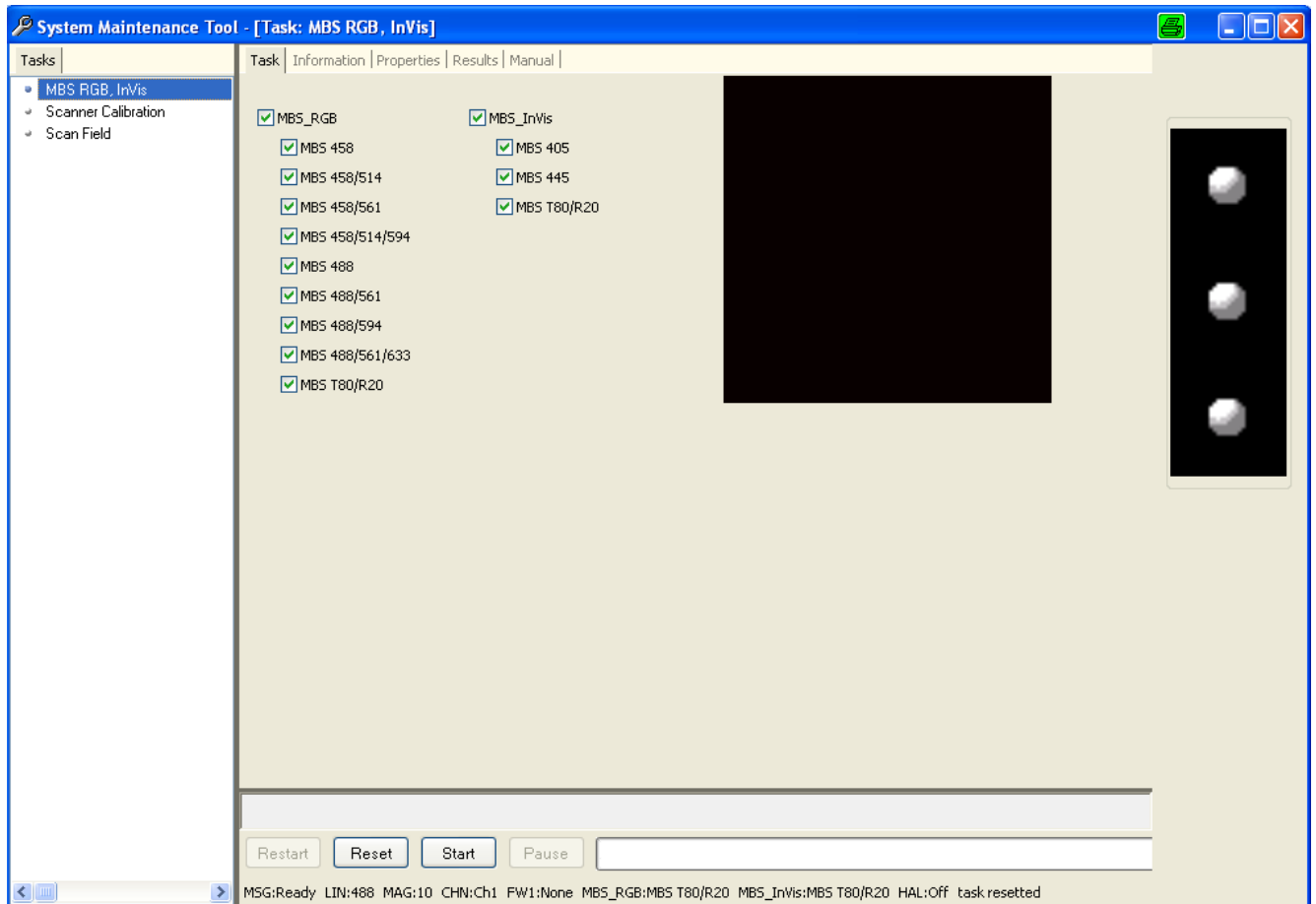


Fig. 47 Maintenance Tool main window

Main beam splitter (MBS) calibration, RGB, InVis:

Allows to automatically adjust the optimal beampath between the MBS, the scanning mirrors and the master pinhole on all LSM 710 and LSM 780 systems. On LSM 710 and LSM 780 systems with additional 405, 440 or IR (NLO) lasers, make sure the respective lasers are checked.

=> Test tool: calibration objective (turret will be set automatically)

- KÖHLER illumination for transmitted light must be properly set

The calibration data will be included in the file "... \ bin \ PH1_6.pos".

Scanner calibration

=> Test tool: calibration objective (turret will be set automatically)

- The scanner calibration requires a properly focused optics (see section 6.4.2).



There is no longer a difference between electrical and optical scanner calibration (as it was with earlier LSM systems).

Scanner linearity test (Scan field):

=> Test tool: calibration objective (turret will be set automatically)

Subset of task scan field checks the scanner linearity and runs much faster than scanner calibration.

Resolution test

=> Test tool: calibration objective (turret will be set automatically)

Checks the resolution of the fine structures on the calibration tool. If the resolution test is not successful, this hints on wrong collimator (and eventually pinhole) positions.

Illumination (optional):

Illumination test (fluorescence) for homogeneous coverage

=> Test tool: Delta Vision Slide orange.

After each call the image exposure needs to be set, so that no magenta-colored pixels can be seen.

 This task requires a service login.

CHAPTER 7 ANNEX

CONTENTS

	Page
7 ANNEX	2
7.1 Software and Hardware Options.....	2
7.1.1 Software	2
7.1.2 Hardware	4
7.2 Courses on "How to Operate the System in an Optimized Way"	5
7.3 Beam path Configuration Guide for Fluorescence Microscopy with the LSM 710 and LSM 780 Systems	6
7.3.1 Optical elements in the Configuration Control window	6
7.3.2 Setup of Tracks Using Single Detectors (channel mode)	6
7.3.3 Beam path Configuration for Multi Photon Excitation.....	9
7.3.4 Acquisition conditions for RICS.....	9
7.4 Recommendations for Excitation Laser Lines and Emission Filters of Dyes	10
7.5 Changing the Filter Wheel in the LSM 710 and LSM 780 Systems	11
7.6 Changing Filters in the LSM 7 LIVE Scanning Module	12
7.7 Mounting and Dismounting the LSM 710 / LSM 780 Scan Head	13
7.8 Detaching / Attaching the LSM 7 LIVE Scanning Module from / to Microscope Stands	14
7.9 Changing Filters in the scanning module of the of the LSM 700	16
7.10 The Use of the Piezo Fine Focusing Stage.....	17
7.10.1 General Description.....	17
7.10.2 Applications of the Piezo Fine Focusing Stage.....	17
7.10.3 Additional Information on the Operation.....	17
7.11 Piezo Objective Focusing Device.....	19
7.12 Z-Piezo Focussing Insert for Scanning Stages	20
7.13 Specifications of Trigger-Interface.....	21
7.14 AxioCam High Resolution Digital Cameras	24
7.14.1 High Resolution Microscopy Camera AxioCam HRm Rev.3 FireWire	24
7.14.2 High Resolution Microscopy Camera AxioCam HRc Rev.3 FireWire	24
7.14.3 AxioCam MRm FireWire	25
7.14.4 Microscope camera ports and camera port adapters for the AxioCam	26

7 ANNEX

7.1 Software and Hardware Options

This section describes optional software and hardware configurations. Depending on your configuration, the content of dialogue and function may differ.

7.1.1 Software

The following software packages for ZEN 2010 are available:

- Software "Physiology "
- Software "Topography "
- Software "Macro Recorder and Editor"
- Software "3D for LSM"
- Software "Multiple Time Series"
- Software "Image VisArt plus"
- Software "Deconvolution"
- Software "StitchArt plus"
- Software "FRAP"
- Software "FRET"
- Software "Visual Macro Editor"
- Software "Image Correlation Spectroscopy"

If your configuration does not include any of the SW packages "Physiology", "FRAP" or "FRET", the following functions are not available:

- Mean of ROI view type and analysis functions

If your configuration does not include the "Physiology" software package, the following functions are not available:

- Mean of ROI scan button in Time Series Control
- Ion Concentration analysis in the Process tab

If your configuration does not include the "FRAP" software package, the following functions are not available:

- Kinetics analysis view type.

If your configuration does not include the "FRET" software package, the following functions are not available:

- **FRET** Macro button in the **Macro** Menu and **FRET** view button

If your configuration does not include the "Visual Macro Editor" software package, the following functions are not available:

- **VME** button in the **Macro** Menu

If your configuration does not include the "Topography" software package, the following functions are not available:

- **Topo** view type in the **Image Display** document.

If your configuration does not include the "Macro Recorder and Editor" software package, the following functions are not available:

- **New, Save** and **Save as** buttons in the **Macro Control** window
- **Edit, Step, Delete, Editor** buttons in the **Macro Control** window

If your configuration does not include the "3D for LSM" software package, the following separate application is not available:

- **3D for LSM**

If your configuration does not include the "Multiple Time Series" software package, the following function is not available:

- Macro: "Advanced Time Series"

If your configuration does not include the "Image VisArt plus" software package, the following functions are only available in a basic, stripped down version.

- **3D** view type in the **Image Display** document

If your configuration does not include the "Deconvolution" software package, the following functions are not available

- **DCV Settings** button in the **Ortho** function of the **Image Display** window
- **DCV** button in the **Process** menu

If your configuration does not include the "StitchArt plus" software package, the following function is not available:

- Macro: "**StitchArt plus**" and **Stitch** function in **Processing**

If your configuration does not include the "Image Correlation Spectroscopy" software package, the following function is not available:

- **Correlation** function in **Processing**

7.1.2 Hardware

Depending on whether the following hardware components are available or not, the content of the screens may differ:

- Piezo objective focusing device / Z-Piezo stage
- X-Y scanning stage (different types available)
- Axio Observer.Z1 / Axio Imager.Z2 / Axio Examiner.Z1
- Depending on the configuration the scan head equipment may differ in filters, beam splitters and the number of photomultiplier
- Transmitted-light PMT
- Non Descanned Detectors (NDD)
- Monitor diode

If your configuration does not include the Piezo objective focusing device or the Z-Piezo stage, the following functions are not available:

- **Hyperfine Z Sectioning** in the **Z Stack** tool in the left tool area
- **Fine Focus** parameters in the **Stage and Focus Control** window

If your configuration does not include a X-Y scanning stage, the following functions are not available:

- **Stage** tool, **Positions** tool and **Tile Scan** tool in the left tool area

Depending on the used microscope stand: Axio Imager.Z2, Axio Imager.M2, Axio Examiner or Axio Observer.Z1, the following dialogue and available functions may differ:

- Context and accessibility of the **Ocular** tab .

If your configuration does not include scan head QUASAR, monitor diode, transmitted light PMT and/or NDD, the following functions may differ:

- Context and accessibility of the **Light Path** tool

If your configuration does not include an AxioCam, the following functions are not available:

- **Camera** in the **Light Path** tool, **Channel** tool

If your configuration does include the LSM *DuoScan* or a second LSM LSM 7 MP scanner the content of the **Bleach** tool varies.

7.2 Courses on "How to Operate the System in an Optimized Way"

Carl Zeiss is offering training courses on how to operate the system in an optimized way.

- Courses are held in our application center in Jena, Germany.
- Courses are held in English or German language, respectively.

Check out:

www.zeiss.de/lsm

for the latest dates and ask your Zeiss representative for a quotation on courses.

7.3 Beam path Configuration Guide for Fluorescence Microscopy with the LSM 710 and LSM 780 Systems

7.3.1 Optical elements in the Configuration Control window

All wavelength values given in Nanometer [nm].

7.3.1.1 Main Dichroic Beam Splitter (MBS)

- A **MBS XXX/YYY** deflects the indicated laser lines onto the specimen and allows the emitted fluorescent light to pass through.
Example: MBS 458/514, MBS 488/543/633 (deflects also UV excitation light)
- A **MBS XXX+** is a special type of a main dichroic used for IR multiphoton excitation. The **MBS 690+** for example, deflects laser light with a wavelength longer as 690 nm onto the specimen and allows fluorescent emission light in the visible range below 660 nm to pass through.
Example: **MBS 690+**
- A **MBS XXX/YYY+** is a combination of a MBS XXX and MBS YYY+ used for simultaneous IR multi photon and single photon excitation.
Example: MBS 405/710+.

7.3.2 Setup of Tracks Using Single Detectors (channel mode)

a) One track only – simultaneous acquisition of channels

- Switch on the suitable lasers for excitation of the dyes in the specimen. For the Argon laser set the tube current of the laser to a value of app. 50% (**Show All**, as described in chapter 4, section 4.3 of this manual). Example: for Alexa 488 and CY 3 switch on **Argon** (blue excitation) and **HeNe1 or DPSS 561** (green excitation).
- Activate the proper laser lines in the **Line Active** check box, set **Transmission [%]** for each active line.
Example: Select 488 to 4% and 543 to 50%
- Select a main dichroic beamsplitter (MBS) which deflects the selected laser lines to the specimen.
Example: MBS 488/543

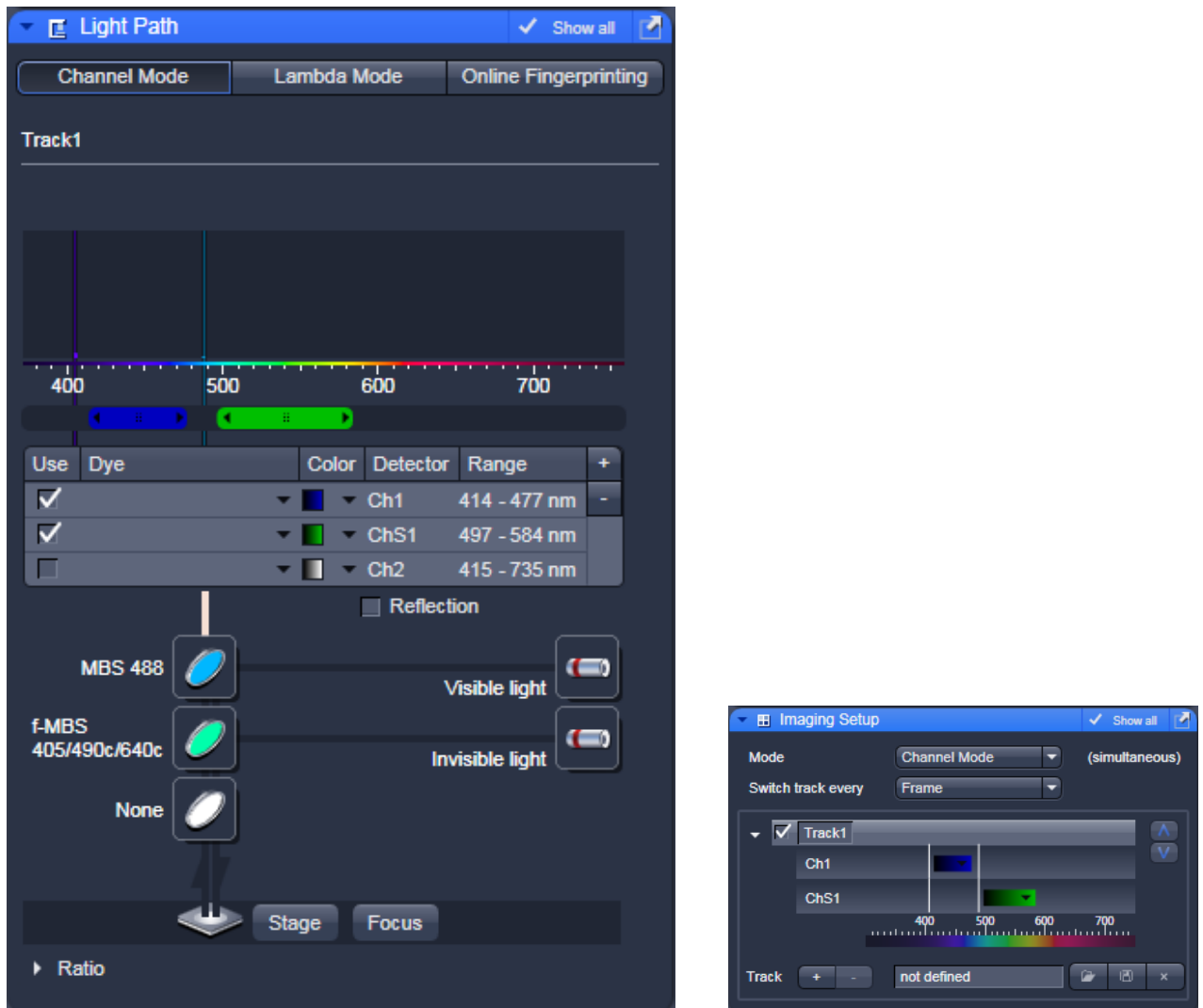


Fig. 1 Light Path tool, Imaging Setup tool

- Select the proper emission bands in front of the channels and activate channels. Example: select > 575 nm in front of Ch 3, and a band of 500 – 550 nm in front of Ch 2.
- Make sure that the active detection bands do not include any of the active laser lines.

Additional hints:

- Do not forget to turn on the corresponding lasers and detectors.
- Assign appropriate colors to these activated channels. Example: Ch 2 - green (for Alexa 488 emission, Ch 3 - red (for CY3 emission)

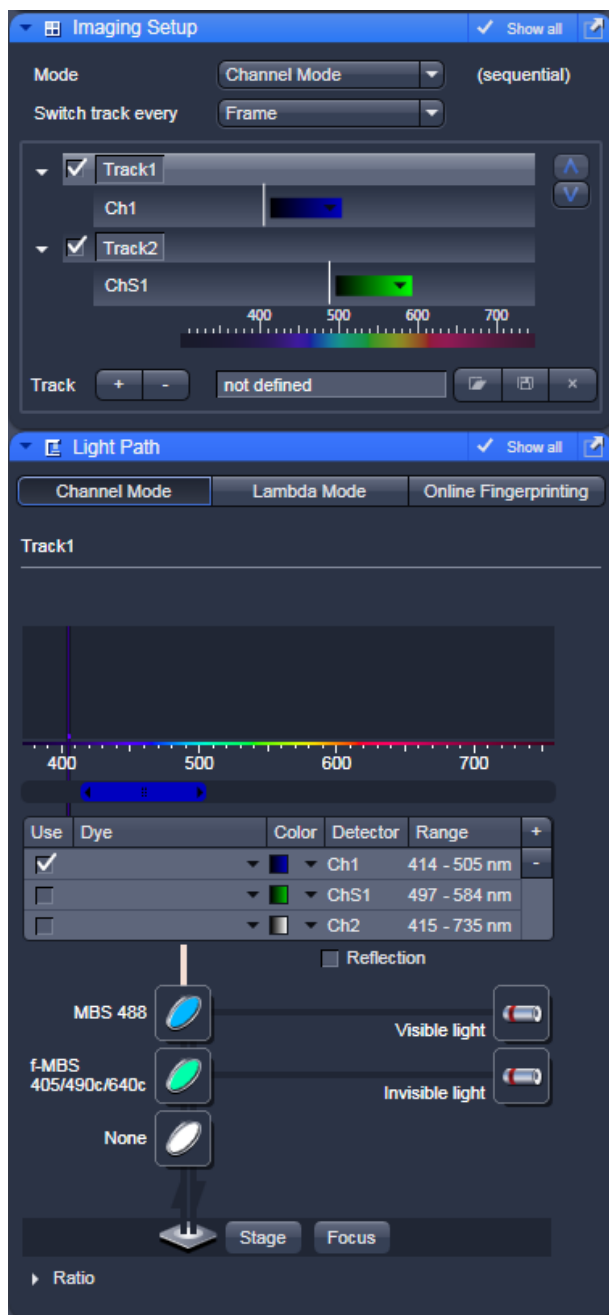



Fig. 2 Image Setup and Light path tools

b) Multiple tracks – sequential acquisition of channels

Multi-tracking is the method of choice for multi-fluorescence imaging. It allows avoiding artifacts from emission crosstalk that can occur in simultaneous excitation and detection of multiple dyes. To sequentially acquire multiple channels, laser lines are switched very fast and channels are recorded quasi-simultaneously.

The configuration of multiple tracks follows the same rules described above for a single track. The main difference is that each track is configured to excite and detected only one fluorescent dye to prevent cross talk (or two dyes with non overlapping emission spectra).

- Create a track for Alexa 488.
- Add a new track by clicking the  button.
- Create a second track for Cy 3.
- By selecting the dyes from the pulldown menu, you can see the emission spectra to set the matching detection bands.

Line and Frame Mode of Multitracking

- Settings can be used for **Line** or **Frame** wise multi-tracking acquisition.
- In Line mode the lines are scanned in turns for all tracks with the corresponding laser lines turned on exclusively. Preferred for living samples with moving objects. Acquisition time can be reduced using bidirectional scan mode.
- In Frame mode, the whole frames are scanned in turns for all tracks with the corresponding laser lines turned on exclusively. This mode can be advantageous for dyes that tend to bleach and need time to recover.
- There are parameters that can be changed quickly in a line wise acquisition: Digital Gain, Digital Offset, Laser Line Attenuation,
- Any other changes of track settings of the selected tracks, e. g. different filters, dichroics or Detector Gain settings, need a bit more time to be changed and therefore should be changed only when Frame mode is used.
- There is a fast Frame mode, which requires identical settings of these parameters.

7.3.3 Beam path Configuration for Multi Photon Excitation

- The beam path configuration for multi photon excitation follows the same rules as described for a single and multi track configuration (see above, paragraph 7.3.2)
- Use a MBS 690+ or MBS 760+ as main dichroic beam splitter to deflect the IR excitation light (690 or 760 -1050 nm) onto the specimen.
- On the detection side, use an additional band pass filter in front of the NDD to prevent a bleed through of IR excitation light to the detector.

7.3.4 Acquisition conditions for RICS

For RICS the pixel size should be at least 5 times smaller than the PSF of the objective, so appropriate zooms have to be employed.

For the C-Apo 40 x objective with a beam radial extension of approximately 0.25 μm zoom factors of 10-20 will guarantee a sufficient size ratio. In addition, scanning speed should not be too high or slow.

As a rule of thumb for solution studies speeds 7-8, for measurements in cytodol and nucleus of 5-6 and for membrabe studies of 3-4 will be appropriate.

Expression levels should not be too high. A maximum of 1 μM concentration can be tolerated.

7.4 Recommendations for Excitation Laser Lines and Emission Filters of Dyes

Dye	Laser line/MBS	Emission bands
DAPI	405	> 385/420, max. at 461
EBFP	405	> 385/420, max. at 447
Hoechst	405	> 385/420, max. at 440
Fluoro-Gold	405 or 458	> 420/475, max. at 536
ECFP	405 or 458	> 420/475, max. at 501
Lucifer Yellow	458	> 475, max. at 536
EGFP	477 or 488	> 505, max. at 507/516
FM 1-43™	477 or 488	> 505, max. at 598
Alexa Fluor 488™	488	> 505, max. at 520
Calcium Green	488	> 505, max. at 531
Cy2™	488	> 505, max. at 508
DiO (DiOC18(3))	488	> 505, max. at 508
Fluo-3	488	> 505, max. at 520
Fluorescein (FITC)	488	> 505, max. at 520
Cy3™	514/532	> 530, max. at 566
EYFP	488 or 514/532	> 530, max. at 535
Oregon Green	514/532	> 530, max. at 535
SYTOX Green	514/532	> 530, max. at 536
FM 4-46	514 or 532/543	> 560, max. at 640
Alexa Fluor 546™	532/543	> 560, max. at 572
Calcium Orange	532/543	> 560, max. at 575
DiI (DiI18(3))	532/543	> 560, max. at 565
DsRed	532/543 or 561	> 560, max. at 583
Tetramethylrhodamine (TRITC)	532/543 or 561	> 560, max. at 576
Rhodamine B	532/543	> 560/585, max. at 625
Texas Red™	561 or 594	> 570/600, max. at 620
Alexa Fluor 633™	633/635	> 650, max. at 654
Cy5™	633/635	> 650, max. at 666

7.5 Changing the Filter Wheel in the LSM 710 and LSM 780 Systems

You can remove and replace filter wheels by push and click.

When opening the cover, the safety control will switch off the laser light.

To exchange the filter wheel of the LSM 710 and LSM 780 systems proceed as follows:

- Loosen the four fastening screws (Fig. 3/1).
- Remove the cover (Fig. 3/2) of the scanning module.
- Turn the filter wheel (Fig. 4/1) until the free position points upwards. Do not touch the filters!
- Grab the filter wheel on its free position and pull it out upwards.
- Grab the new filter wheel on its free position. Do not touch the filters!
- Insert the new filter wheel and snap it into the holder.
- Close the cover and fasten the four screws.

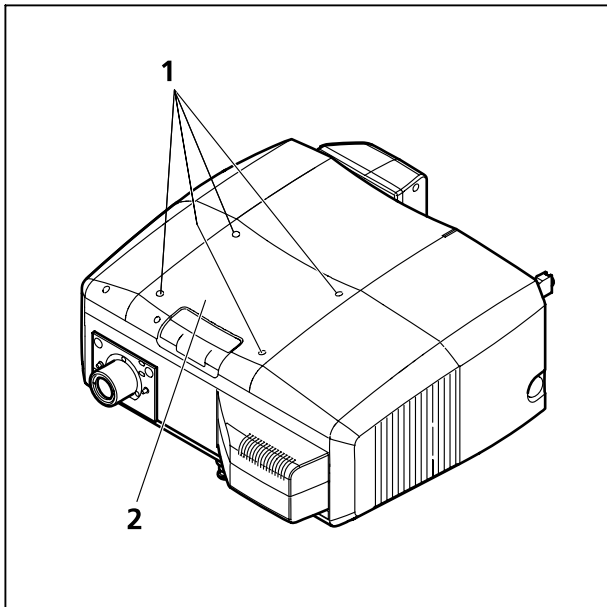


Fig. 3 Removing the cover

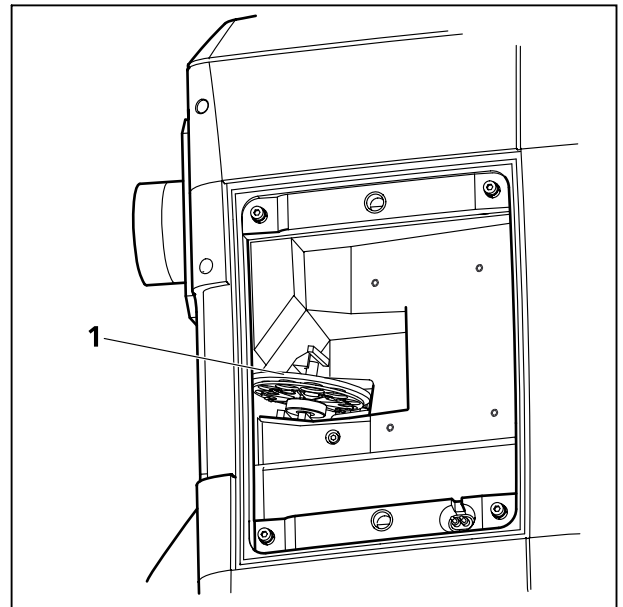


Fig. 4 LSM 710 / LSM 780 filter wheel

7.6 Changing Filters in the LSM 7 LIVE Scanning Module

For optimum investigation of specimens it is useful to employ filter wheels permitting the motor-controlled change between different filters for narrow-band or broad-band detection depending on the wavelength. The number of filters is limited by the capacity of the filter wheel. The change of the filter wheel as a whole involves complete readjustment.

The filter can be exchanged as a whole. Please ask your local LSM specialist to do this exchange in order to maintain your warranty.

Filter-wheel change

- Pull the filter-wheels carefully out of the appropriate guide well, see Fig. 5:
 - **1** – filter-wheel 1 for emission filters (EM 1)
 - **2** – filter-wheel for secondary dichroic beam splitters (NFT)
 - **3** – filter-wheel 1 for emission filters (EM 2)
- Use the filter exchange tool carefully and applying as little force as possible to pull the filter-wheel.
- Do not touch the filters.

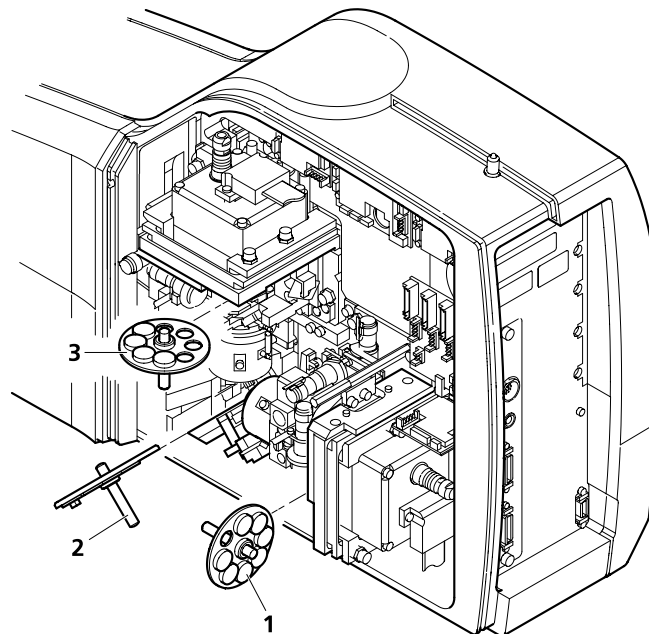




Fig. 5 Change-over of the filter-wheels

- Change filter-wheel to suit the application. Make sure that the filter-wheel is correctly fitted in the mount.
- Enter the designation of this particular filters into the System Software database.

7.7 Mounting and Dismounting the LSM 710 / LSM 780 Scan Head

The scan head is connected to the microscope via an integrated safety interlock. It can be moved between two microscopes. Make sure the system is shut off completely before starting the following procedure:

-  Be aware that the scan head weights up to 28 kg.
-  Please see chapter 1 for safety relevant cables and connections.

Moving the scan heads between Axio Observer.Z1, Axio Examiner and Axio Imager.Z2:

- Loosen the three fastening screws of the LSM 710 / LSM 780 (Fig. 6/1 and Fig. 7/1).
- Slowly pull the scanning module (Fig. 7/2) away from the microscope port or the tube (Fig. 7/3).
- For mounting the scan head onto a microscope, make sure the pins and the electronic connections of the safety interface match closely.
- Push the scan head to the microscope or the tube.
- Fasten the three fastening screws of the LSM 710 / LSM 780 (Fig. 6/1 and Fig. 7/1).

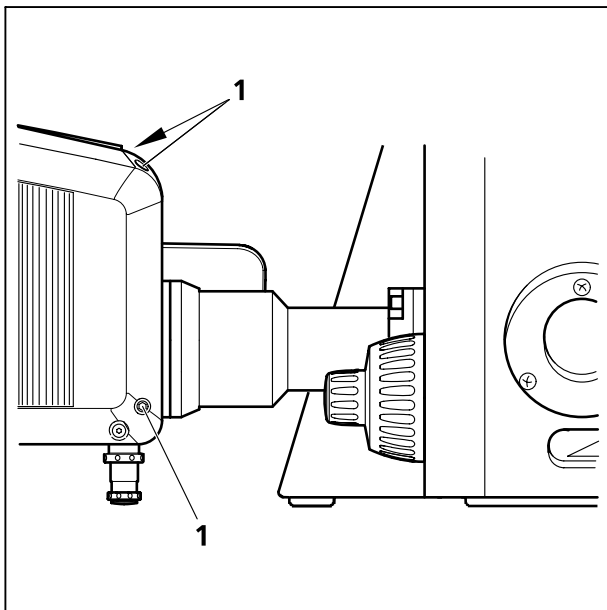


Fig. 6 Port connection between LSM and Axio Observer.Z1

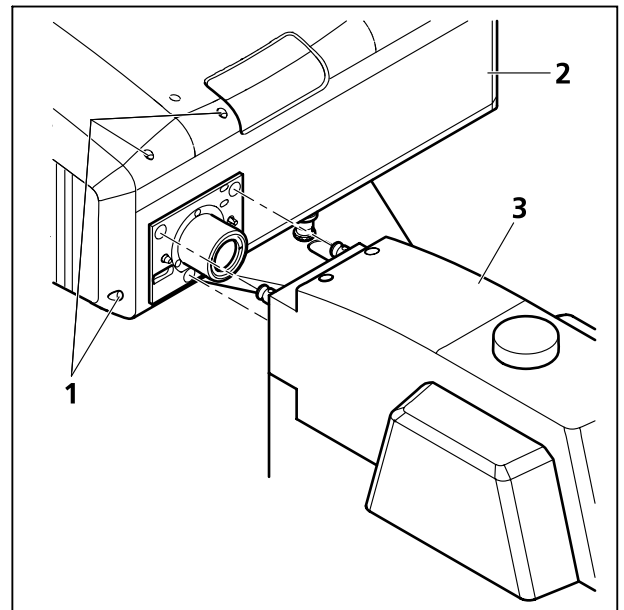




Fig. 7 Port connection between LSM and Axio Examiner or Axio Imager.Z2


7.8 Detaching / Attaching the LSM 7 LIVE Scanning Module from / to Microscope Stands

Tool needed: 3 mm Allen key

 The user can remove the Scanning Module from one microscope and attach it to another within a few minutes. Described below is the change-over from an Axio Examiner to an Axio Observer.Z1 in sideport configuration.


 **Before** the change-over, **shut down** the system as described in chapter 4 in order to avoid damage to the system and loss of data.

- Loosen the three screws (8/1) at the Scanning Module (8/2) fitted to the Axio Examiner.
- Cautiously pull Scanning Module off the Axio Examiner stand.
- Attach Scanning Module to the left sideport of the Axio Observer.Z1, minding the guide pins (8/5), and secure it with the three screws (8/1).

 As the Scanning Module is heavy, weighing about 19.5 kg, it is easier if the changeover is carried out by two persons.

- Pull off covering caps (8/3) from the CAN-BUS and RS232 interface ports at the rear of the Axio Observer.Z1, remove the two cables 457411-9011 (CAN-BUS) and 457411-9012 (RS232) from the Axio Examiner, plug them into the Axio Observer.Z1 and secure them there.
- Switch the LSM 7 DUO on.
- Click on the **Stand select** icon to update the system database with the new database of the Axio Observer.Z1 microscope.
- Restart the ZEN software.

 Please see chapter 1 for safety relevant cables and connections.

 For optimal performance, an optical realignment of the LSM 7 LIVE scanhead is mandatory. Use the **Kollimatic** macro for this procedure, as described in chapter 4.

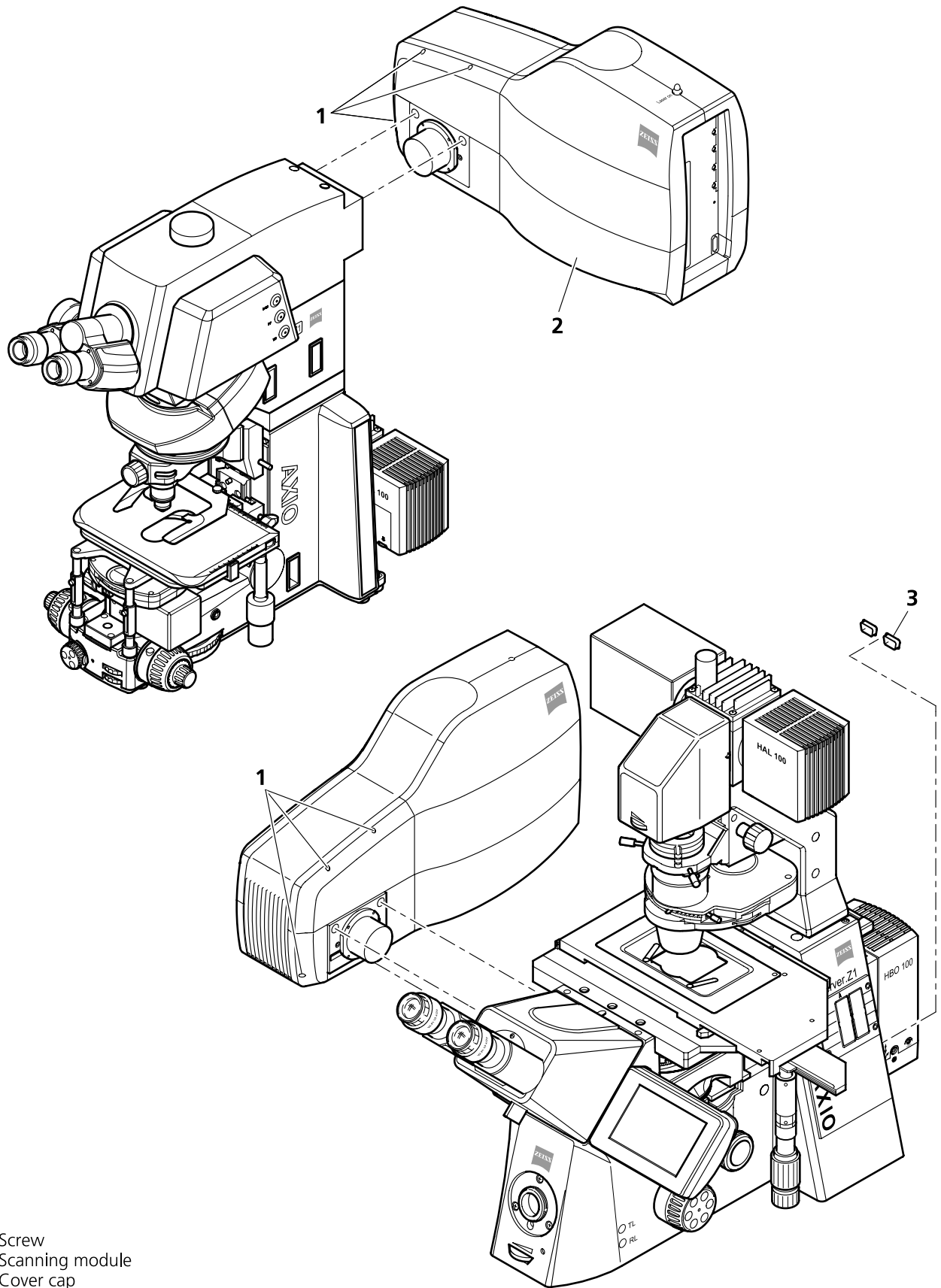


Fig. 8 Change-over of the Scanning Module

7.9 Changing Filters in the scanning module of the of the LSM 700

For optimum investigation of specimens it is useful to employ filter wheels permitting the motor-controlled change between different filters for narrow-band or broad-band detection depending on the wavelength. The number of filters is limited by the capacity of the filter wheel. The change of the filter wheel as a whole involves complete readjustment by trained Zeiss service personnel.

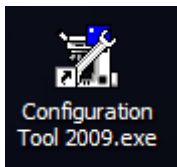
The filter wheels of channel 1 (vertical filter wheel) and 2 (horizontal filter wheel) of the Scanning Module have 7 positions in which a filter, including its mount, can be changed in a reproducible position without requiring readjustment.

Removing the cover from the scanning module

- Close the software and **switch off the instrument. Make sure the instrument is disconnected from electricity and the laser rack is switched off using the power switch on the back of the rack!**
- Unscrew the 4 hex socket screws on the customer side of the scanning module. The screws are not secured against falling out!
- Pull cover cap off the Scanning Module.
- Unscrew the 4 screws to open the black cover.

Filter change

- Turn the filter wheel required into a position where the filter to be changed is accessible.
- Use the filter tool carefully and applying as little force as possible to pull the filter mount with the filter out of the guide well.
- Change filter to suit the application. Make sure that the filter is correctly fitted in the mount.
- **Enter the designation of this particular filter into the System Software database by using the Configuration Tool.**



The link is on the desktop, if this is not the case – the program can be found in C:\ZEN\HWT\

7.10 The Use of the Piezo Fine Focusing Stage

7.10.1 General Description

The Piezo fine focusing stage is a compact attachment for the Axio Imager.Z2, Axioskop 2 FS MOT and Axio Observer.Z1 microscope stages, which allows the particularly fast and high-precision fine focusing of the object. The piezo stage permits fine focusing over a range of up to 250 µm (200 µm guaranteed), with the smallest step width being less than 10 nm, reproducibility better than 40 nm, and the maximum speed amounting to 60 Hz. The stage allows the use of specimens with a weight of less than 100 g.

The piezo stage is not used if manual coarse focusing is performed. To position the objective in relation to the optical Z-axis, the standard XY-microscope stage is used.

The piezo stage features a mount for standard object carriers of 76 mm x 26 mm x 1 mm and a milled-out receptacle for Ø 36 mm x 1 mm Petri dishes.

7.10.2 Applications of the Piezo Fine Focusing Stage

- High-precision fine focusing and translation of the object along the optical axis.
- Fast and high-precision mounting of one-dimensional Z-line sections.
- Fast and high-precision mounting of two-dimensional R-Z-longitudinal sections.
- Fast and high-precision mounting of XY-Z-Stacks for the three-dimensional reconstruction of the object.
- Exact measurement of Point-Spread-Functions for deconvolution.

7.10.3 Additional Information on the Operation

The piezo fine focusing stage is a high-precision, sensitive accessory for the LSM systems from Carl Zeiss and must therefore be treated carefully.

High mechanical stress, such as the use of specimens weighing more than 100 g or the application of pressure or knocks on the movable stage tongue, can result in damage and therefore in failure of the stage function.

To be able to fully utilize the outstanding precision attainable with the fine focusing stage, anything which could interfere with its operation, especially mechanical knocks and impact of the LSM system components, should be avoided. We would recommend you to always use the actively vibration-damped table.

The specifications of the stage are obtained only after a warm-up phase of approx. 30 minutes. Furthermore, the installation conditions for the LSM system must be observed.

The maximum reproducibility (better than 40 nm) for moving to an absolute position in Z is achieved by always moving to the required position from below.

Fine focusing is performed mechanically via an inclined position of the stage tongue. Therefore, the lifting range Z at the location of the image field depends on the position of the piezo stage in relation to the optical axis. This means: if the user shifts the object on the microscope stage to the right via the piezo stage, the lift will be different from the one in the zero position of the stage (max. 250 μm) and also from the one after a shift of the stage to the left.

If the LSM system is equipped with a motorized scanning stage, this shift is read back to Δx and the lift is calibrated automatically if the zero position of the piezo stage has been matched to the zero position of the scanning stage via an initialization run. For this, activate the **Stage** button of the **Acquire** toolbar. Then position the scanning stage in such a way that the optical axis of the microscope corresponds to the zero position of the piezo stage, i.e. to the center of the specimen holder in the stage tongue. Then perform initialization by pressing the **piezo Null** button. This step must be repeated after every new start of the system. Also see the notes on the operation of the motorized scanning stages.

If the system is equipped with a manual microscope stage, the user has the option of performing the calibration by entering the Δx shift in mm via the **Calibration** slider.

The shift is read off from the microscope stages. In the case of the manual Axio Imager stage, Δx can be read directly from the scale adhered to the front of the stage. In the case of the manual Axio Observer.Z1 stage, a scale is located on the right of the knob, where the 45 mm Δx shift relative to the zero position of the microscope stage can be read off. The Δx value is positive for both stages if shift from the zero position is made to the right and negative if the shift is made to the left.

On account of the inclined position of the stage tongue, the object is also shifted laterally during the fine focusing motion. This lateral shift is negligibly small if, as recommended by us, specimen carriers with thickness 1.0 mm are used exclusively. Otherwise, the marked lateral shift of the object during fine focusing can result in image distortion. For the same reason, Petri dishes without fixation ring must be used exclusively.

The nosepiece of the Axio Observer.Z1 stand is moved to the load position prior to switching off the LSM system and the piezo stage is then moved to the lowest position to avoid damage of the objective or object by a possible collision. The user must refocus after start-up of the system. Before an objective change in the Axio Observer.Z1 or the Axio Imager.Z2 the nosepiece and the microscope stage must be moved to the load position by the user, and then back to the work position to prevent the objectives from hitting the piezo components. This is performed automatically if the objectives are changed menu-controlled via the relevant buttons of the ZEN program.

7.11 Piezo Objective Focusing Device

For Axio Imager.Z2, Axio Imager.M2 and Axio Observer.Z1

Range: $\geq 200 \mu\text{m}$

Minimum step size: 15 nm

Speed:

		Piezo objective focussing device
Slices	Step size [μm]	xz-lines / s
20	0.5	460

Objectives:

- W0.8/M27
- Modified Achromplan 40x / 0.8 W with reduced length to compensate for piezo height

Installation:

- Screw in your microscope objective into Piezo Objective Focusing Device (see Fig. 9/1).
- Screw the thread-ring into your microscope (see Fig. 9/2).
- Easy clamp the Piezo Objective Focusing Device on the thread-ring (see Fig. 9/3).

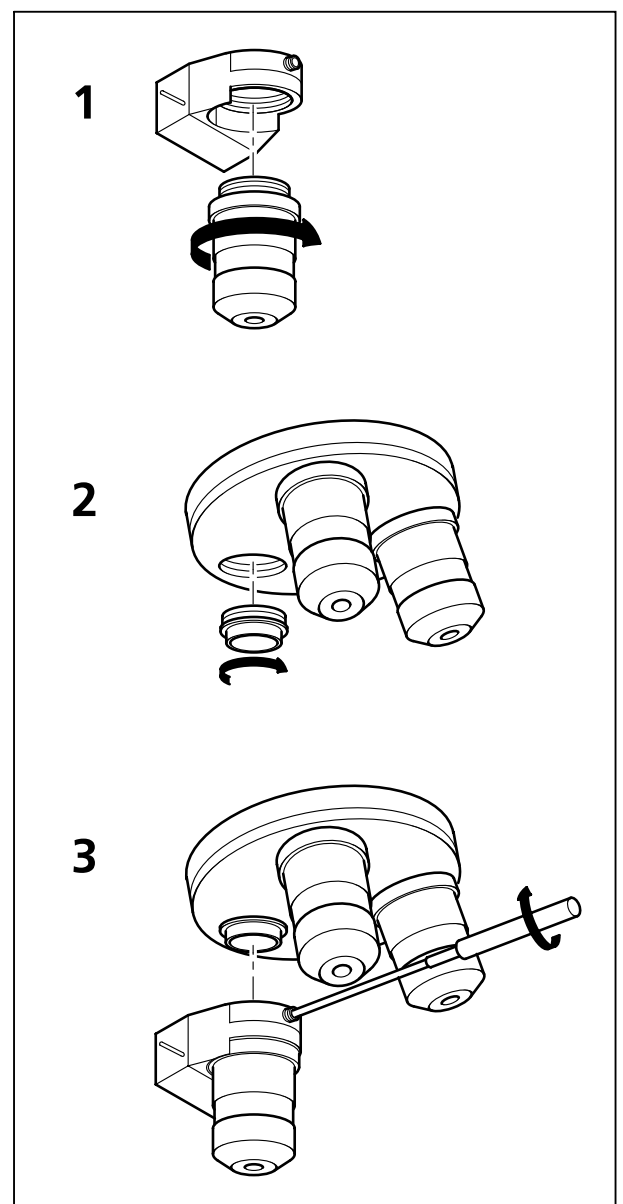


Fig. 9 Installation of the Piezo Objective Focusing Device

7.12 Z-Piezo Focussing Insert for Scanning Stages

For Axio Imager.Z2, Axio Imager.M2 and Axio Observer.Z1

Range: $\geq 200 \mu\text{m}$

Minimum step size: 5 nm

Speed:

		Piezo objective focussing device
Slices	Step size [μm]	xz-lines / s
20	0.5	290

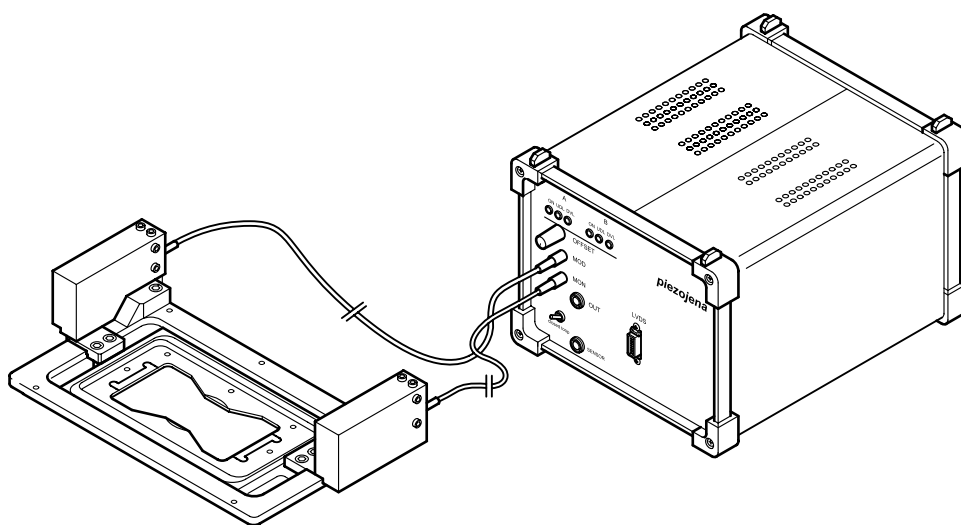


Fig. 10 Z-Piezo focusing insert for scanning stages

The Z-Piezo stage can only be mounted onto scanning stages. The insert is used instead of the standard inserts. The Z-Piezo insert needs to be screwed onto the scanning stage to ensure maximum fixation to the stage. It can hold classic objective slides and 35 mm Petri dishes.

7.13 Specifications of Trigger-Interface

Application:

With LSM 710, LSM 780, LSM 710 NLO, LSM 780 NLO and LSM 7 MP you can control various actions externally using Trigger-In or force external devices to work at a defined time depending on an action using Trigger-Out during time series.

These actions are: Scan-Start / Stop, Bleach, Change of Scan-Interval, end of a countdown, set marker into image or even a mouse-click on a button.

Interface:

- User Port Adapter on the back of the Real Time Electronics in the System Electronic Rack
- Connector 2x **15-point** high density D-Type plug, 1x coax with outer shield (Triax Lemo S. A. Serie 00, EPL.00.650NLN)

Number:

- 8x signal IN (all able to generate an interrupt)
- 14x signal OUT (10 synchronous, 4 asynchronous relative scan position)
The label synchronous refers to the data stream PCIe2LVDS.
The label asynchronous refers to the data stream PCIe2LVDS.
All input signals are asynchronous.
- 1x clock

Connector:

Coax: Triax Lemo S. A. Serie 00, EPL.00.650NLN

Pin	Signal name	Description
Signal	PCLK_Out	PixelClock Output
Signal shield	GND	Digital ground
Outer shield	Shield	Chassis ground

The pixel clock is exactly symmetrical to the pixel. For example if the pixel rate is 10 kHz the high-level and the low level both have a time of 50 microseconds. The width of the TTL pulse therefore is $1/(2 \times \text{pixelrate})$.

15-point high density D-Type plug: Plug "A"

Pin	Signal name	Description	Software interface
1	SyncOUT0 synch output	Synchronous output	Trigger 1 out
2	SyncOUT1	Synchronous output	Trigger 2 out
3	SyncOUT2	Synchronous output	Trigger 3 out
4	SyncOUT3	Synchronous output	Trigger 4 out
5	GND	Digital ground	-
6	AsyncOUT0 asynch output	Asynchronous output	-
7	AsyncOUT1	Asynchronous output	-
8	AsyncOUT2	Asynchronous output	-
9	+5 V	Va	-
10	GND	Digital ground	-
11	AsyncIN0 input	input	Trigger 1 in
12	AsyncIN1	input	Trigger 2 in
13	AsyncIN2	input	Trigger 3 in
14	AsyncIN3	input	Trigger 4 in
15	Connector detector*	Input / Connector detector	-

15-point high density D-Type plug: Plug "B"

Pin	Signal name	Description	Hardware output only
1	SyncOUT4 ** (stack)	Synchronous output	Sync. signal: Stack out
2	SyncOUT5 out Grabbing	Synchronous output	Sync. signal: Grabbing
3	SyncOUT outline **	Synchronous output	Sync. signal: Line out
4	SyncOUT outframe **	Synchronous output	Sync. signal: Frame out
5	GND	Digital ground	-
6	SyncOUT6	Synchronous output	-
7	SyncOUT7	Synchronous output	-
8	AsyncOUT6	Asynchronous output	-
9	+5 V	Asynchronous output	-
10	GND	Va	-
11	AsyncIN4 input	Digital ground	-
12	AsyncIN5	Asynchronous input	-
13	AsyncIN6	Asynchronous input	-
14	AsyncIN7	Asynchronous input	-
15	Connector detector*	Input / Connector detector	-

*) If the pin is connected to ground, the software recognizes that at least one connector is connected to the UserPort2.

**) The position of the two switches on the UserPortAdapter inside the RT-PC must switch thrown towards enclosure = default position.

Timing of the synchronization signals Stack out, Line out and Frame out

These signals are directly generated by the hardware and cannot be influenced by the software. They are also not seen by the user software and cannot be used to generate any markers within the image acquisition. They are highly precise tools to control external hardware. The signals are precise to the pixel and depending on the chosen pixel time the time between the signal and the start of the image acquisition varies.

The Line out signal is set 44 pixels before the first image pixel of each line.

The Frame out signal is set 42 pixels before the first image pixel of each frame.

The Stack out signal is set 40 pixels before the first image pixel of each Z-stack.

The signal itself is identical to the signal of the pixelclock but is only set for one pixel.

The Grabbing signal is set to high-level with the start of data grabbing and set to low-level with the stop of data grabbing for each line.

Type/Voltage Range:

- TTL signal level 3.3 V, CMOS low power consumption
- 5.0 V tolerant input/output for interfacing with 5 V logic

Load:

- Output: < 50 mA (internal serial 68 ohm resistor)
- Input: 4.7 kOhm input impedance (internal 4.7 kOhm pullup to 3.3 V)

Trigger pulse description:

Signal output:

- Low level < 0.4 V, high level > 2.4 V (I = 10 mA)
- Slew rate 10 ns/V
- Reaction time trigger out 8 msec typical

Signal input:

- Low level <0.5 ... 0.8 V, high level >2.0 ... 5.5 V
- Falling edge force interrupt
- Pulse width to detect signal > 50 ns
- Reaction time trigger in 16 msec typical

Caution:

- Never apply more than 5 V or negative voltages to avoid any damage.
- In and outputs are not galvanically decoupled.
- Therefore proper measures for galvanic decoupling of external devices have to be taken (opto-coupler etc.).

7.14 AxioCam High Resolution Digital Cameras**7.14.1 High Resolution Microscopy Camera AxioCam HRm Rev.3 FireWire**

Cat. No	426511-0000-000, incl. digital interface and cable
High Range Monochrome	
Number of Pixels:	1388 (H) x 1040 (V) = 1.4 Mega pixel
Chip size:	8.9 mm x 6.7 mm, equivalent to 2/3"
Spectral range:	With BK-7 protection glass up to 1000 nm, with IR barrier filter BG40 limited to about 350 nm to 700 nm

Selectable Resolution by Binning or Microscanning

H	x	V	Acquisition Time (s) @ 20 ms exposure
1388	x	1040	0.2 (5 images / s)
2776	x	2080	0.8 (1.25 images / s)
4164	x	3120	1.7
Dynamic Range:			Better than 2000 : 1 @ 8 e readout noise
Integration Time:			1 ms to several minutes
Cooling:			Single stage Peltier cooling
Optical Interface:			C-Mount
Size:			about 11 cm x 8 cm x 6.5 cm (2.3" x 3.2" x 2.6")
Registration:			CE, cUL
Power Supply:			12 V DC, 1 A, 230 V/110 V, autodetecting

7.14.2 High Resolution Microscopy Camera AxioCam HRc Rev.3 FireWire

Cat. No	426510-0000-000, incl. digital interface and cable
High Range Color	
Number of Pixels:	1388 (H) x 1040 (V) = 1.4 Mega pixel
Chip size:	8.9 mm x 6.7 mm equivalent to 2/3"
Spectral range:	Limited by IR barrier filter BG40, about 400 nm to 700 nm

Selectable Resolution by Binning or Microscanning

H	x	V	Acquisition Time (s) @ 20 ms exposure
1388	x	1040	0.2 (Color interpolation)
1388	x	1040	0.8 (full resolution for color channels)
2776	x	2080	2.9 (full resolution for color channels)
4164	x	3120	6.5 (full resolution for color channels)
4164	x	3120	1.6 (Fast Scan)
Dynamic Range:			Typical 2000 : 1 @ 9 e readout noise

Integration Time:	1 ms to several minutes
Cooling:	One stage Peltier cooling
Optical Interface:	C-Mount
Size:	about 11 cm x 8 cm x 6.5 cm (2.3" x 3.2" x 2.6")
Registration:	CE, cUL
Power Supply:	12 V DC, 1 A, 230 V/110 V, autodetecting

7.14.3 AxioCam MRm FireWire


Number of Pixels:	1388 (H) x 1040 (V) = 1.4 Mega pixel
Chip size:	8.9 mm x 6.7 mm, equivalent to 2/3"
Spectral range:	about 350 nm to 1000 nm, BK 7 protective cover glass

Resolutions with Binning:

H	x	V	
276	x	208	(Binning 5 x 5, RGB)
346	x	260	(Binning 4 x 4, B/W)
462	x	346	(Binning 3 x 3, RGB)
694	x	520	(Binning 2 x 2, B/W)
1388	x	1040	(Single exposure)

Live image frame rates:

Max. frame rate	Mode	H	x	V	Binning
11 frames/s	slow	1388		1040	1
26 frames/s	medium	460		344	3
38 frames/s	fast	276		208	5

 Above frame rates are supported by the camera electronics at 20 ms exposure time, computer hardware, operating system and application software may influence the frame rates.

Digitization:	12 Bit / 24.57 MHz
Dynamic Range:	typical > 2200 : 1
Integration Time:	1 ms up to 20 s
Cooling:	single stage Peltier-cooling
Optical Interface:	C-mount adapter
Size / Weight:	about 11 cm x 8 cm x 4.5 cm / 370 g
Registration:	CE, cUL
Power Supply:	12 V DC, 350 mA (no external power supply required)

7.14.4 Microscope camera ports and camera port adapters for the AxioCam

In order to mount a Camera onto the AxioObserver.Z1, the following parts are needed

To use the front port of the microscope:

Adapter Video V200 C 2/3" 0.63x at front port Axio Observer.Z1 Cat. No 000000-1071-171

To use the side port left on the microscope:

Sideport 60N 3 Positions. Cat. No's. 425151, 425154, 425155.

and

Camera Adapter 60N C 2/3" 0.63x Cat. No. 426113-0000-000

In order to mount a Camera onto the Axio Imager M2, Z2 the following parts are needed

Camera path deflection on the left side, interface 60N Cat. No. 425103-0000-000

Path deflecting mirror 100% for camera deflection, 34x46x4 mm Cat. No. 425110-9110-000

and

Camera Adapter 60N C 2/3" 0.63x Cat. No 426113-0000-000

In order to mount a Camera onto the Axio Examiner the following parts are needed

Camera Adapter 60N C 2/3" 0.63x Cat. No 426113-0000-000

 **No other cameras are supported by the LSM Software!**

CHAPTER 8

MULTIPHOTON LASER SCANNING MICROSCOPY WITH LSM FAMILY SYSTEMS

CONTENTS

	Page
8	MULTIPHOTON LASER SCANNING MICROSCOPY WITH LSM FAMILY SYSTEMS 2
8.1	NLO (Non Linear Optics) Laser for LSM 710 NLO, LSM 780 NLO and LSM 7 MP 2
8.1.1	Laser Control tool 3
8.1.2	Imaging Setup and Light Path tool 4
8.1.3	Pinhole and Collimator Settings..... 4
8.2	Non Descanned Detection (NDD)..... 5
8.2.1	Mounting and Dismounting of NDD modules from the NDD port 6
8.2.2	Electronic Connection of NDD modules 6
8.2.3	Filter for non descanned detectors (NDDs) 8

8 MULTIPHOTON LASER SCANNING MICROSCOPY WITH LSM FAMILY SYSTEMS

8.1 NLO (Non Linear Optics) Laser for LSM 710 NLO, LSM 780 NLO and LSM 7 MP

The LSM 710 NLO, LSM 780 NLO and LSM 7 MP scanning module are operated with a Titanium-Sapphire-Laser to perform Multiphoton Microscopy. Depending on the type of laser the following operation procedures apply:

- The operation of software controlled lasers (Chameleon laser from Coherent or Mai Tai laser from Spectra Physics) is integrated into the LSM software.
 - Both lasers should be kept in Stand by mode for daily or weekly operation. The cooling of the laser must not be shut down during stand by. Only in case of more than two weeks without operation the laser should be shut down completely. This has to be performed according to the operation manual for the laser provided by the manufacturer. The shut down and the start procedure can take up to one hour.
 - Specific for the operation of Chameleon lasers (Coherent; for further details please refer to the operators manual of the laser):

The key on the front panel of the laser power supply is used for switching between Stand by mode and Operation mode.

 The laser has to be in Operation mode in order to control it with the LSM software.

- Specific for the operation of Mai Tai lasers (Spectra Physics; for further details please refer to the operators manual of the laser):

The laser is put to **Operation** mode or Stand by mode using the LSM software. Therefore no further operation of the laser via the laser power supply and electronics unit is needed. The key on the front panel of the laser power supply can also be used to put the system from Standby to ON. It is also an interlock key. When the key is removed the system cannot be operated. The key needs to be in ON position to be able to control the laser with the software. The power switch on the laser electronics has to be kept **On** for leaving the laser in Standby.

- Operation of Verdi Mira lasers (Coherent)

These lasers are not operated via the ZEN software. Refer to the operator manual of the manufacturer for using these lasers in combination with the LSM 710 NLO, LSM 780 NLO or LSM 7 MP. However it is needed to indicate the tuned wavelength in the software to ensure the appropriate setting of the AOM frequency (as described below in section 8.1.1).

8.1.1 Laser Control tool

The **Laser Control** tool shows the NLO laser as an additional laser of the system.

Operation of the Chameleon (Coherent) and Mai Tai (Spectra Physics) laser

- Click **On** to activate the laser for the software. The laser is put from Standby to Operation and the power ramps up. This takes a few minutes until the laser is ready. The system now has access to the laser and reads out the actual status of the laser.
- The wavelength and laser intensity (transmission through an Acousto-Optical Modulator, AOM) are controlled in the laser control pop up from the **Light Path** tool.
- Enter the desired wavelength in the **Edit Laser Wavelength** input box.

Operating a Verdi Mira laser

- For other lasers: The laser itself is not switched on when clicking **On**, this has to be done manually on the laser control unit. The software is informed that the laser is switched on and the laser safety shutter in the AOM box can be opened.
- The wavelength has to be tuned manually and then entered manually in the **Edit Laser Wavelength** input box.

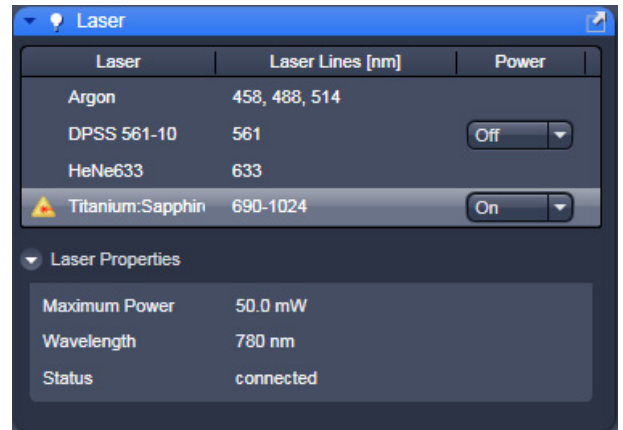


Fig. 1 Laser control tool

8.1.2 Imaging Setup and Light Path tool

Application of the NLO laser requires special main dichroic beam splitters to be activated in the **Light Path** tool.

NLO-excited signals can be detected in every channel. However, it is important to efficiently block NIR (near infrared) excitation stray light from the detector.

The following filters are designed for detection of NLO-excited fluorescence signals:

- **MBS 690+**: main dichroic beam splitter reflecting NIR excitation longer than 690 nm, transmitting shorter wavelengths
- **MBS -405/760+**: main dichroic beam splitter reflecting NIR excitation longer than 760 nm, transmitting shorter wavelengths and reflecting 405 nm excitation for simultaneous detection of signals from NIR and 405 excited fluorochromes.

8.1.3 Pinhole and Collimator Settings

- The pinhole can be fully opened for maximum detection efficiency due to the intrinsic optical sectioning capabilities of the NLO effect (see **Channel window**).
- In the **Pinhole & Collimator Control** window, the **NIR** collimator can be used to align the overlap of the excitation planes within the object for VIS as well as NIR excitation light in the **Collimator** panel (see **Maintain** menu, **Pinhole** button).

8.2 Non Descanned Detection (NDD)


The use of Non-Descanned Detectors with the LSM 710, LSM 780 NLO and LSM 7 MP is only useful in combination with the NLO laser.

The Non-Descanned Detection modules can be used on the reflected or transmitted-light beam path (transmission NDDs not available for Axio Imager) or simultaneously on both beam paths. This means that up to 10 NDD channels (depending on the microscope used) can be configured. If NDD channels have been assigned to the transmitted-light beam path on Axio Observer, no transmission PMT can be implemented.

In Non-Descanned Detection, the radiation emitted by the specimen is directly guided onto the relevant detector without passing the scanner mirror again.

Non-Descanned Detection is set and configured in the **Light Path** tool by choosing the **Non-Descanned** tab next to the **LSM** tab. This tab is only available when NDD detectors are connected.

- Click on the **Non-Descanned** tab to change to Non-Descanned Detection.
- After checking a box next to a channel the corresponding detection window is indicated in the bar in the upper part of the window. Within each bar an arrow opens a drop down window which allows choosing the fluorescent dye to be imaged. Its emission profile is then indicated in the spectral display.

 The configuration of multiple tracks is possible for NDD applications, but they can not be combined with tracks which are set up with the standard channels.

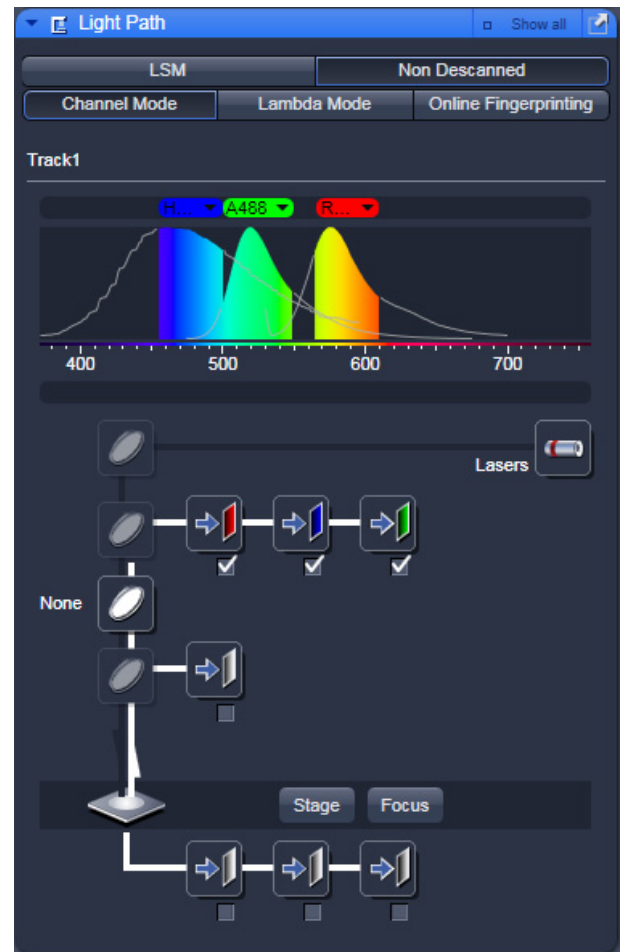


Fig. 2 Light Path tool with NDD detectors (3 in reflection, 3 in transmission) plus GaAsP nosepiece NDD detector on Axio Examiner

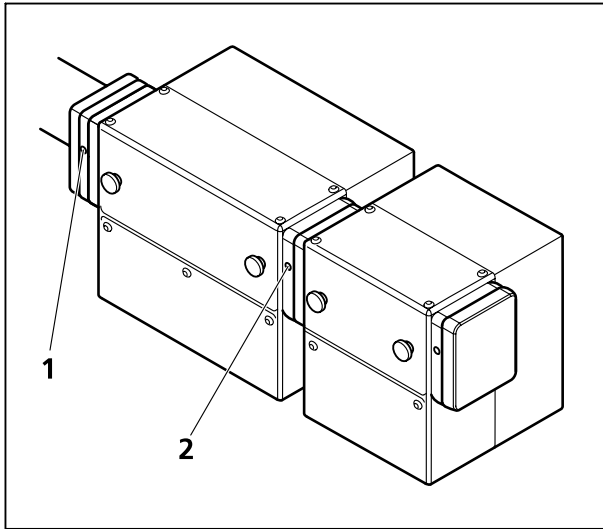


Fig. 3 Mounting and dismounting NDD modules

8.2.1 Mounting and Dismounting of NDD modules from the NDD port

To take off a NDD module from its port or from the NDD module before loosen the screws (Fig. 3/1 und 2) on the port connection. There are two screws at each connection port to fix the modules to the port or to each other. The ports are electronic connections, be careful when removing or mounting the modules. Each unoccupied port must be covered by the blind plate; otherwise the system is not safe and does not work.

Make sure not to use two modules of the same type on one LSM system. This leads to errors in the system and one of the modules will not be recognized. If a two channel module is extended with additional modules, the NDDs must be supported using the provided support posts which have to be fixed to the table.

8.2.2 Electronic Connection of NDD modules

The electrical connection of transmitted and reflected light NDD modules needs to be done to two different LVDS connectors.

On the realtime electronics unit, there are 4 LVDS ports, A-D (Fig. 4).

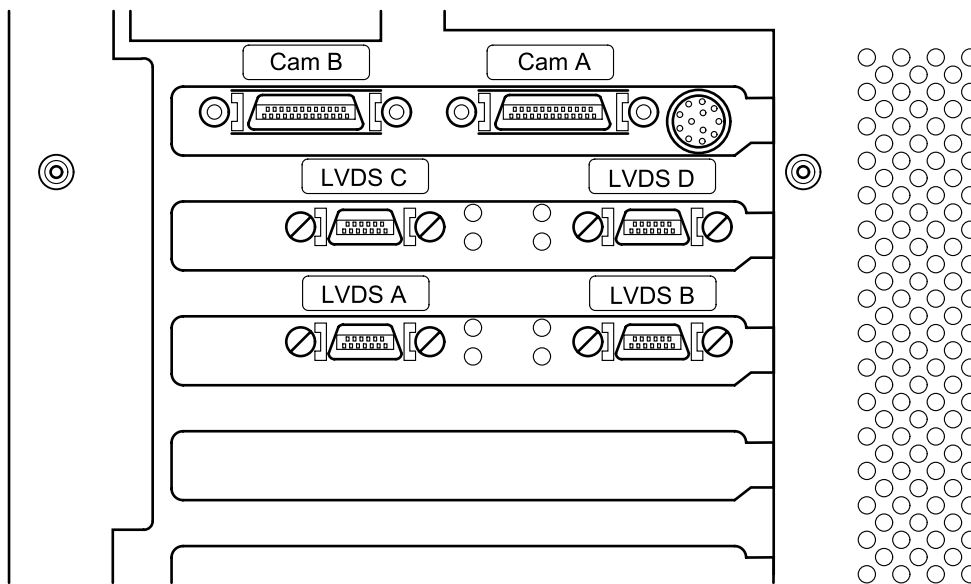


Fig. 4 LVDS connectors on the back of the realtime electronics unit.

The NDD detectors need to be connected to the systems in the following way:

	LSM 710 NLO, LSM 780 NLO	LSM 7 MP
LVDS A	(710 / 780 module)	GaAsP nosepiece NDD Detector (followed by LSM 7 MP I)
LVDS B	T-PMT (via 710 / 780 module)	Transmitted Light Detector (TPMT) (followed by LSM 7 MP M)
LVDS C	Reflected light NDDs (followed by NDD channel 5 , followed by GaAsP nosepiece NDD Detector)	Reflected light NDDs (followed by NDD channel 5)
LVDS D	Transmitted light NDDs	Transmitted light NDDs (followed by NDD channel 5)

If NDDs are present at a LSM system some of the hardware components are connected via sub-LVDS to the real time electronics as listed above. The NDD channels 3 and 4 only have to be connected to the 2 channel NDD module but don't need a connection to the realtime electronics.

In addition the power connections have to be made in the following way to the plugs on the back of the electronics rack:

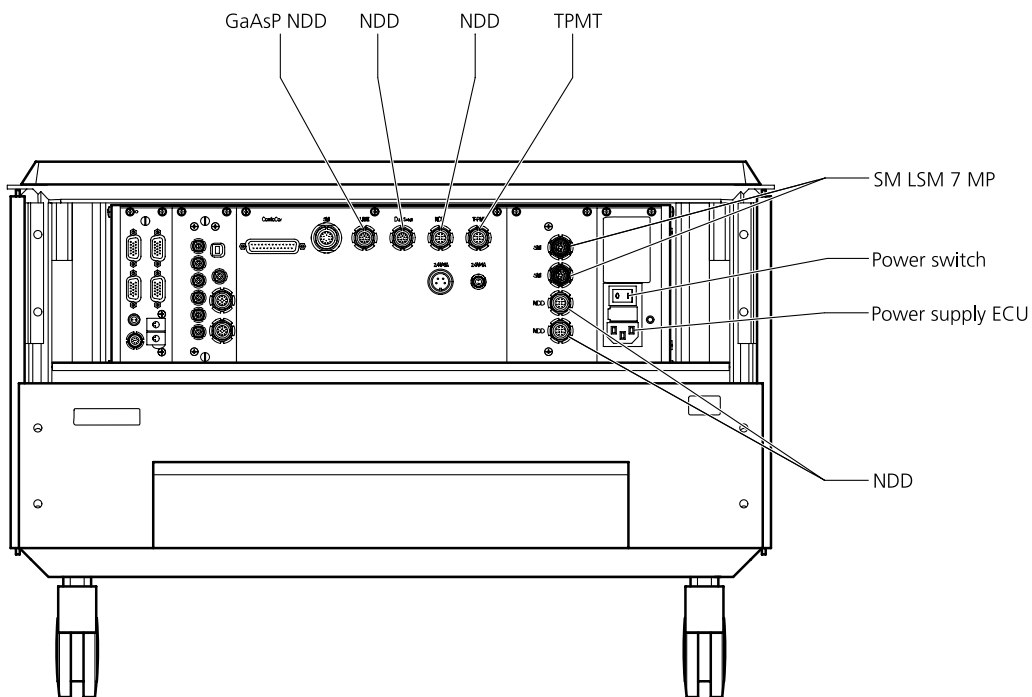


Fig. 5 Power connections of NDD detectors and the scan modules on the electronics rack of the LSM 7 MP.

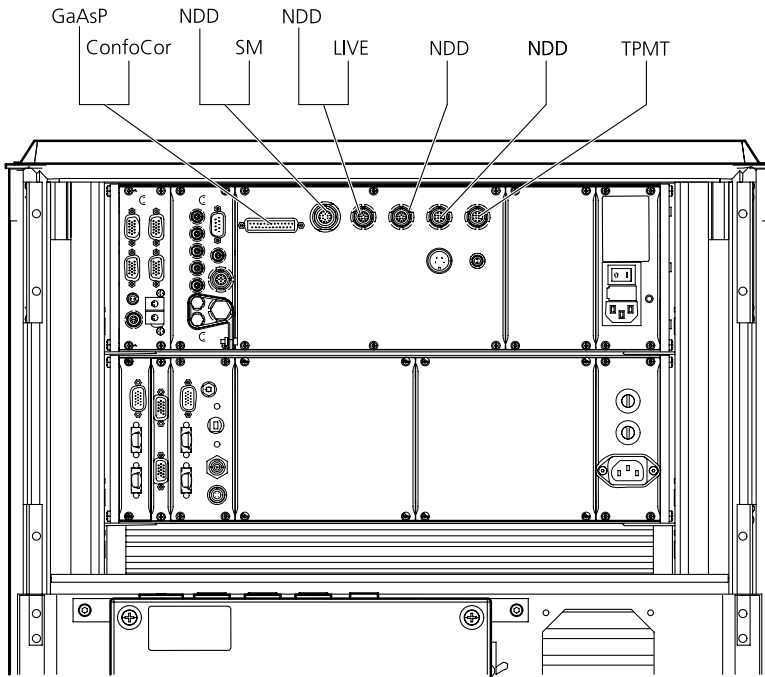


Fig. 6 Power connections of NDD detectors and the scan modules on the electronics rack of the LSM 710 NLO and LSM 780 NLO.

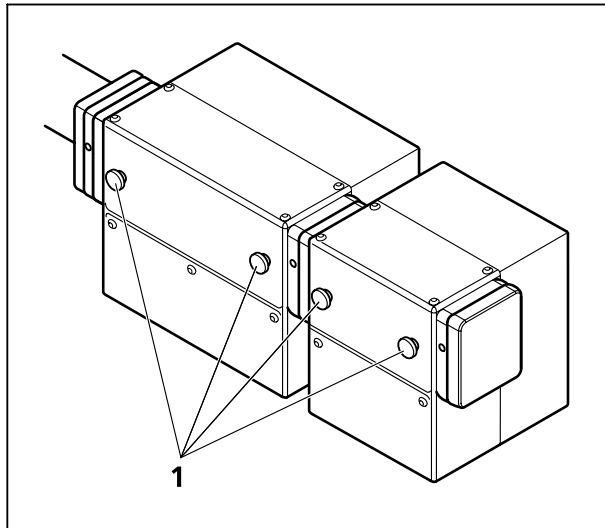


Fig. 7 Thumbscrews of the P&C sliders

8.2.3 Filter for non descanned detectors (NDDs)

To make the best use of NDDs it is necessary to achieve optimal blocking of the excitation laser light. This is done in the same way for all LSM 710 NLO and LSM 780 NLO systems with NDDs independent of the microscope used.

The first NDD module, which is attached to the NDD port, is always a two channel module (Fig. 7/1). Inside this module right at the opening towards the microscope is a small clamping that holds a blocking filter (1442-160 or 1442-161; order# Feb. 08). Both filters are short pass filters which block the IR light of the multiphoton laser with an optical density (OD) of at least 7. If none of these filters is installed, the image quality will not be sufficient as too much laser light will get to the detectors. Always make sure one of these filters is in place.

To install them, open the metallic grey lid of the NDD module turning the thumbscrews (Fig. 7/1). Once the lid is removed the clamping is accessible. Slid in the filter, which is attached to a small holder, into the clamping with the little screw on the side of the holder situated on the left side of the holder when facing towards the microscope.

All emission filters offered for the NDD modules have an additional IR blocking capacity of OD 5. Other filters without these characteristics may lead to inferior image quality.

All secondary dichroics for the NDDs Push&Click filter cubes are long pass filters. They split the emitted fluorescence according to the indicated wavelength into the longer and shorter spectral range. In this respect the dichroics are specified in the spectral range of 380 to 800 nm.

The Emission filters are mounted into Push&Click filter cubes which are clamped into the slider of the NDD modules. NDD modules with two channels hold two Push&Click filter cubes. NDD modules with one channel hold one Push&Click filter cube. The NDD module to be used for the end of the cascade does not have a slider for a Push&Click filter cube.

- To change the cubes simply take out the sliders which hold the cubes by unscrewing them from the rest of the module using the thumbscrews (Fig. 7/1).
- The filter cubes can now be mounted onto the slider by sliding the side noses of the cubes under the corresponding spring latches. The orientation of the dichroics and emission filters is indicated on the slider.

The arrangement of the filters inside the NDD modules depends on the orientation of the modules on the microscope.

For LSM 710 NLO and LSM 780 NLO systems on **Axio Observer** the NDDs are attached to the sideport (up to 5 channels are possible) or the transmission port (maximum of two channels is possible). All dichroics offered by Zeiss for this modules, are long pass dichroics. Therefore the blue part of the spectrum is detected with the first NDD whereas the red part is guided further on to the following NDDs (Fig. 8).

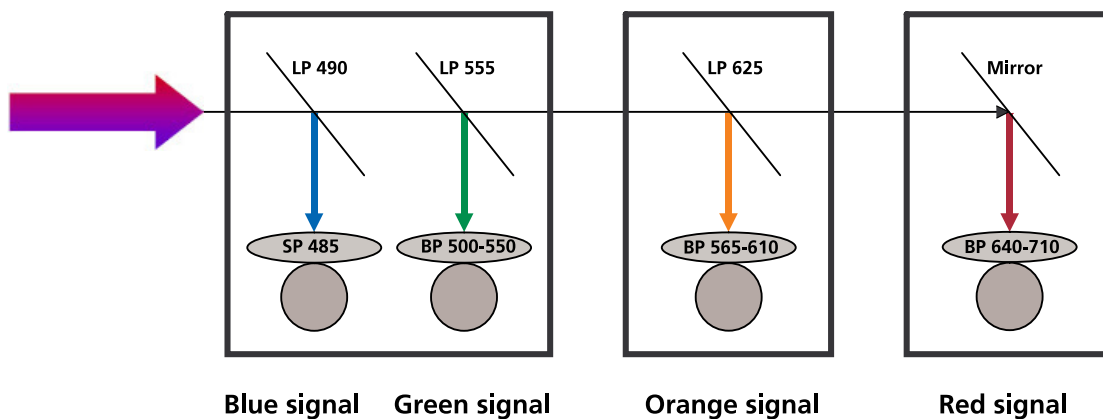


Fig. 8 Example for a filter equipment of a four channel NDD set up on Axio Observer starting with an NDD module type C or D

For LSM 710 NLO and LSM 780 NLO systems on **Axio Imager** (NDDs are only available for reflection) and **Axio Examiner** a total of 5 detectors can be mounted onto the ports starting of with a two channel module of type A or B.

The filter arrangement could be as described in Fig. 9. As the dichroics are also long pass filters channel 1 always needs to see the red part of the spectrum followed by the blue part of the spectrum within the required detection range. If more than 4 channels are required in reflection, a fiber coupled illumination system (X-Cite 120) instead of a standard HBO lamp is required.

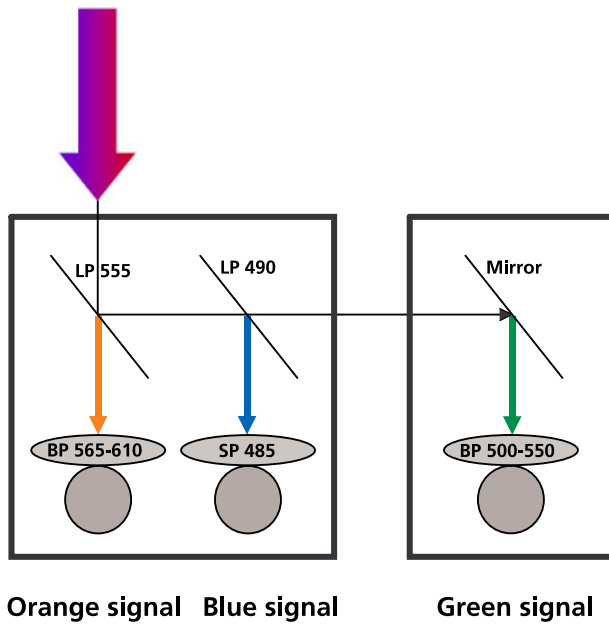


Fig. 9 Potential filter equipment for a three channel NDD set up on Axio Examiner starting with an NDD module type A or B

Adding NDD channel 3, 4 or 5 to an existing set up does require rearranging and swapping of individual filters within and between single P&C cubes for the systems with Axio Examiner or Axio Imager.

For example, to add a fourth channel to the cascade shown in Fig. 10 with a filter combination to additionally detect an emission signal in the far red range the filters have to be rearrange the following way:

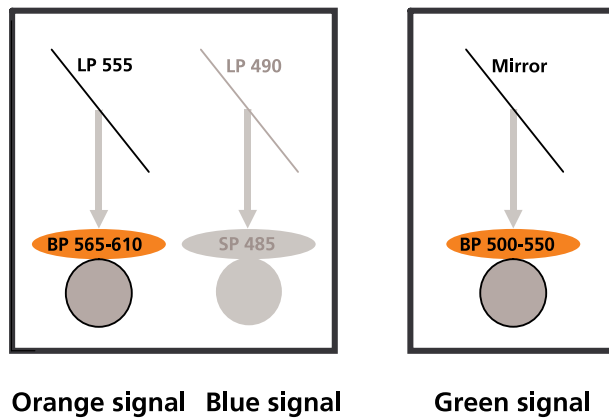


Fig. 10 Emission filters that need to be interchanged when upgrading a three channel to a four channel system using the standard filter set.

The emission filters in the filter cube for the green channel in front of channel three is interchanged with the emission filter of the filter cube for the orange signal which sits in front of channel one.

The cube with the mirror (now detecting the orange signal) is then placed in the new additional NDD module.

The filter cube with the emission filter for the green signal is then placed in front of channel three. The new additional filter cube for the red signal is placed into the two-channel NDD module in front of channel one. The result is shown in the following figure:

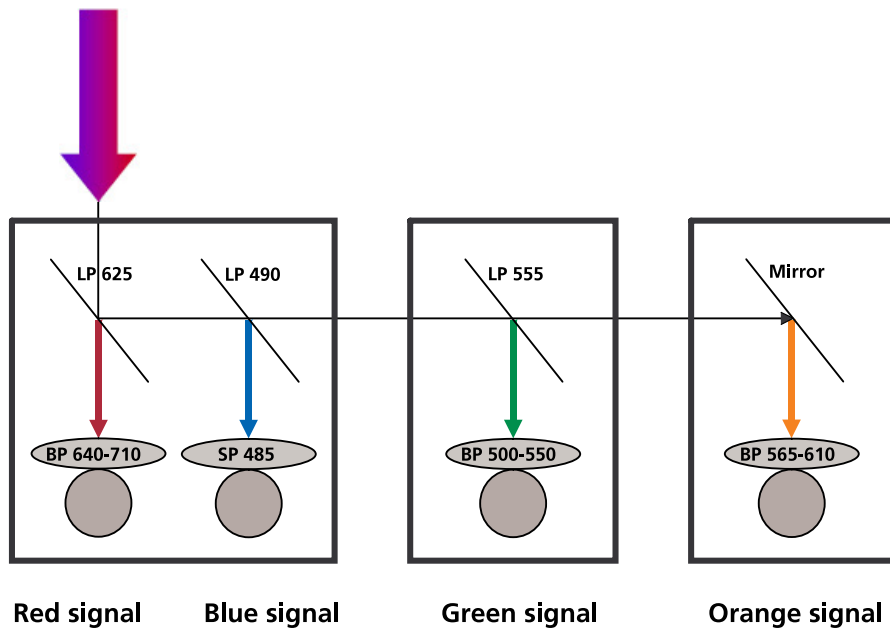
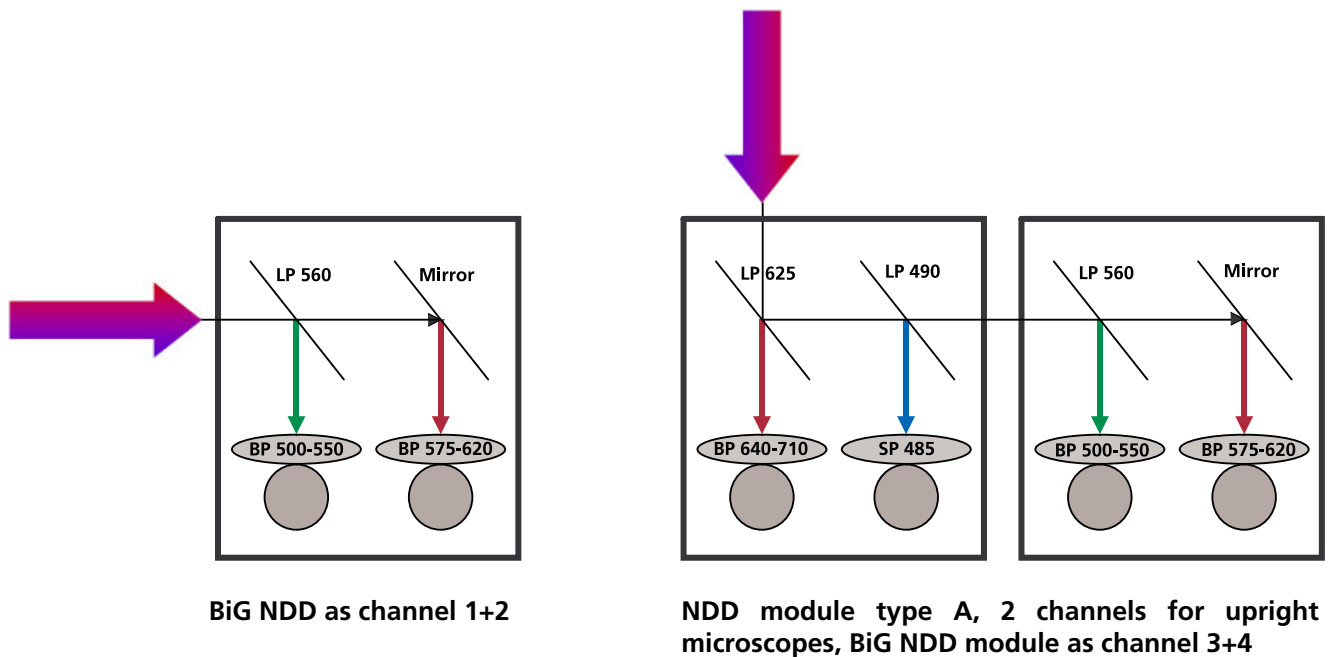


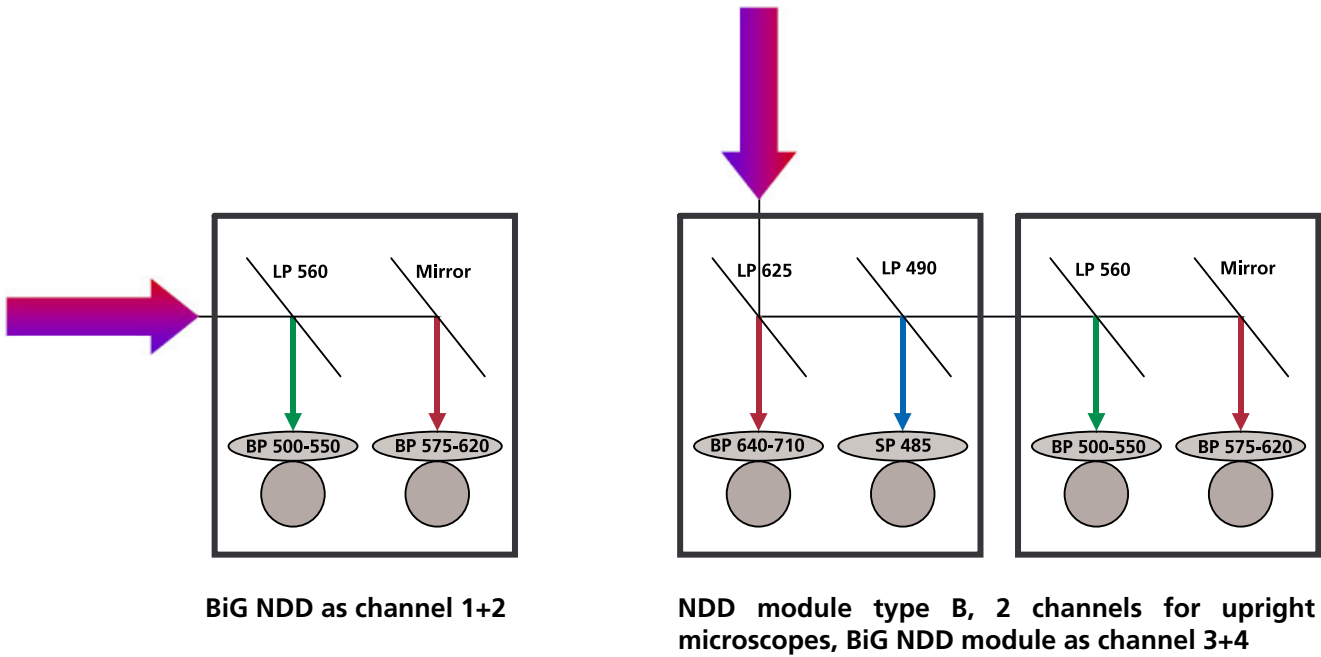
Fig. 11 Potential filter equipment for a four channel NDD set up on Axio Examiner starting with an NDD module type A or B

For Axio Examiner and Axio Imager:

LSM Detector BiG with GaAsP at Reflected Light NDD Port

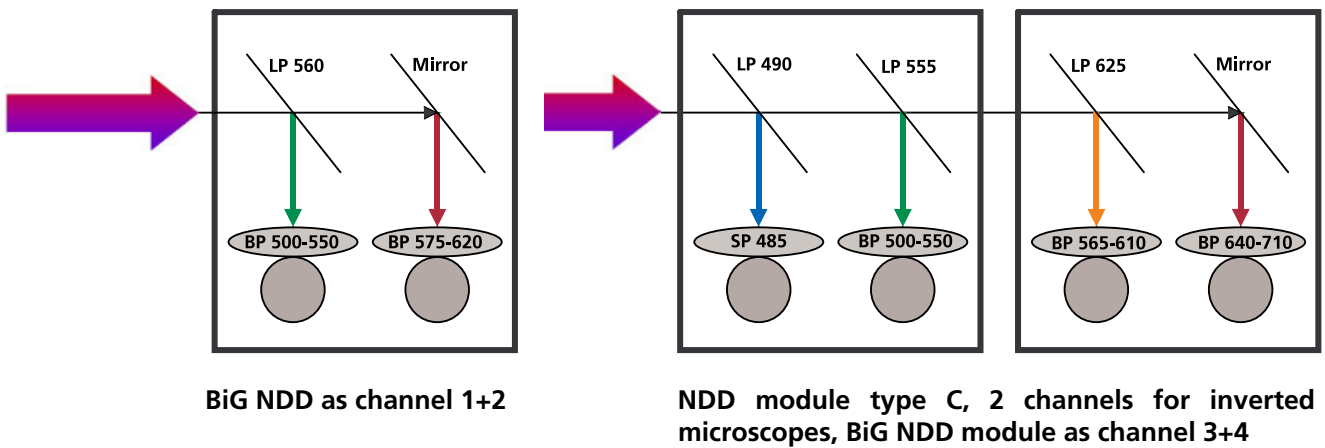


For Axio Examiner: LSM Detector BiG with GaAsP at Transmitted Light NDD Port



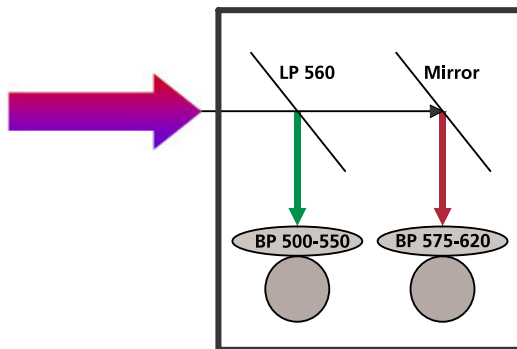
For Axio Observer:

LSM Detector BiG with GaAsP at Reflected Light NDD Port



LSM Detector BiG with GaAsP at Transmitted Light NDD Port

External detection module BiG DC/transmitted light



**BiG NDD as channel 1+2;
no additional NDD modules can be attached**

Once the NDD modules are connected and the filters are placed in front of the detectors, the hardware needs to be indicated to the software. This is done using the software "Configuration tool". Open the software which is either an icon on the desktop or placed in the HWT folder of the ZEN folder. Choose the NDD tab as shown in Fig. 12.

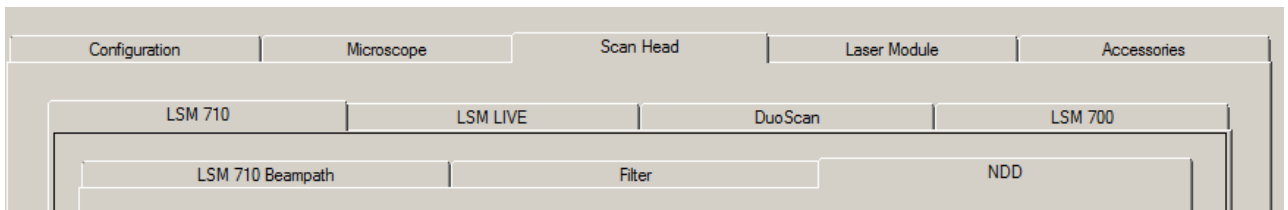


Fig. 12 Configuration tool with NDD tab active

In this tab the type (Fig. 13) and number of NDD modules (Fig. 14) can be set. From a drop down list the type of filter placed in front of each channel can be selected (Fig. 15). If an individual filter is used it can be defined by choosing "New filter" in the drop down list. In the additional window opening the filter parameters can be edited.

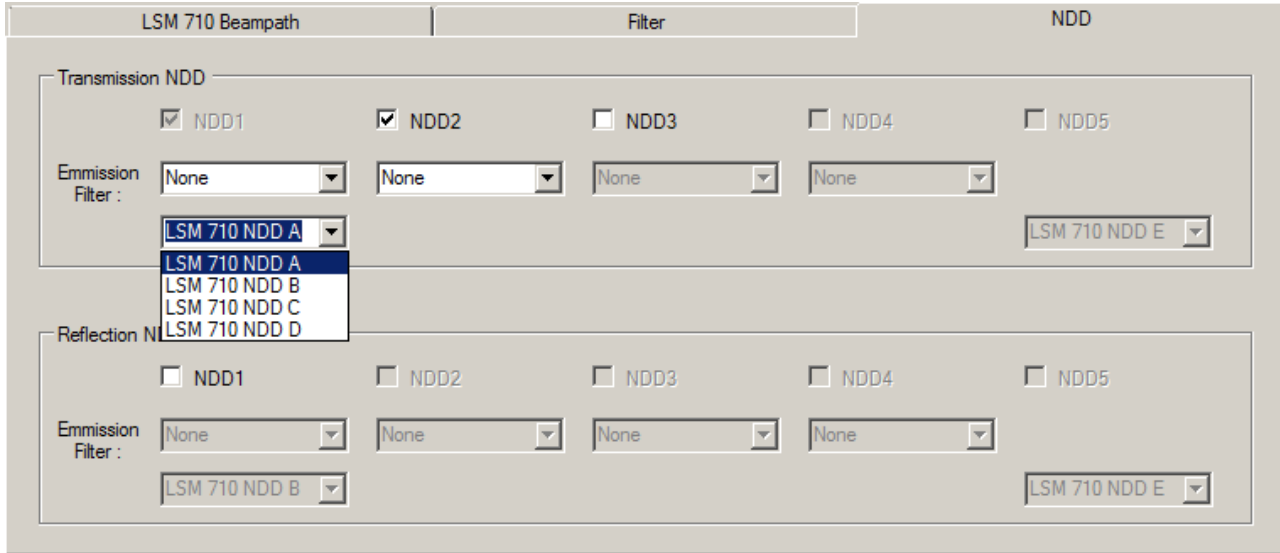


Fig. 13 Configuration tool with NDD tab active. In the drop down list the type of the NDD module can be selected. The type (A, B, C or D) is indicated on the module itself.

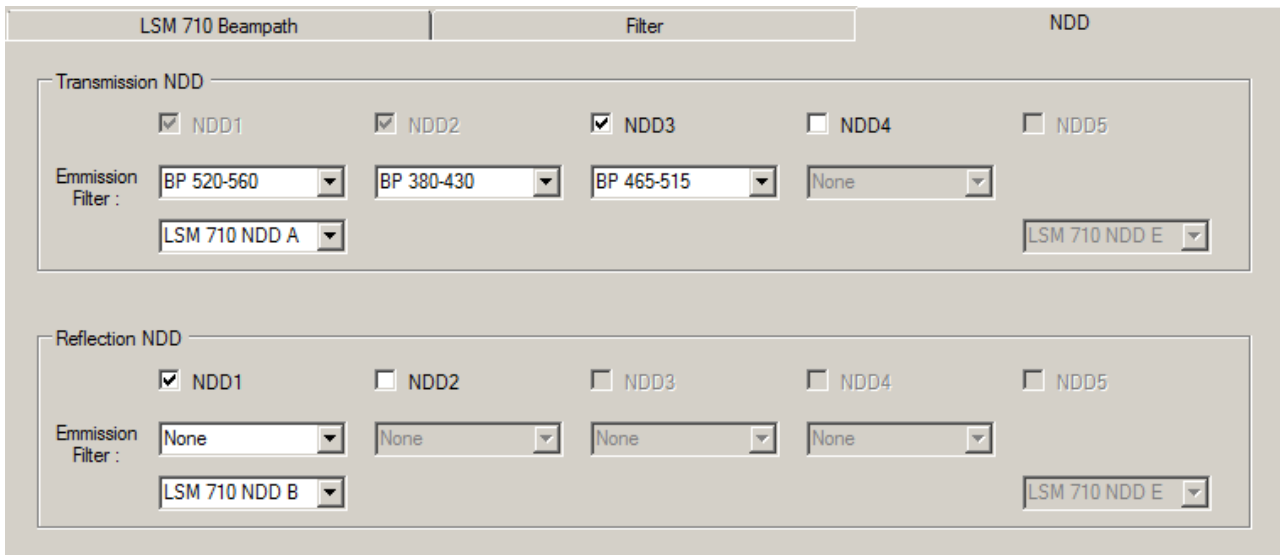


Fig. 14 Configuration tool with NDD tab active. In the example there are three NDD channels in transmission and one channel in reflection indicated to the software.

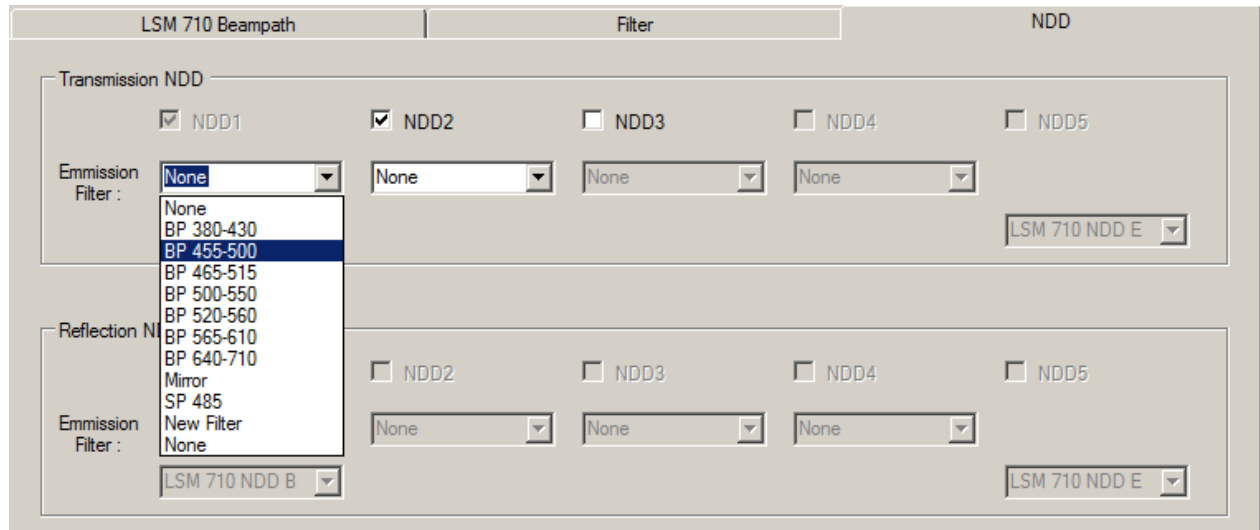


Fig. 15 Configuration tool with NDD tab active. The drop down list shows the available filters. The one positioned in front of the corresponding channel needs to be selected.

GaAsP nosepiece NDD detector

This detector module is located in a special objective holder. It replaces a standard objective holder on the Axio Examiner. It holds one objective. Standard objectives need to be used together with the optical adapter provided.

For attaching the holder to the microscope, check the manual for the Axio Examiner for details on exchanging objective holders. Make sure the detector is then connected to the real time electronics and the power supply as described in section 8.2.2.

To indicate the detector to the software use the configuration tool in the following way:

Open the tab for the Microscope and choose the tab Objectives. In the top most drop down list choose the 1 position Objective nosepiece (Fig. 16).

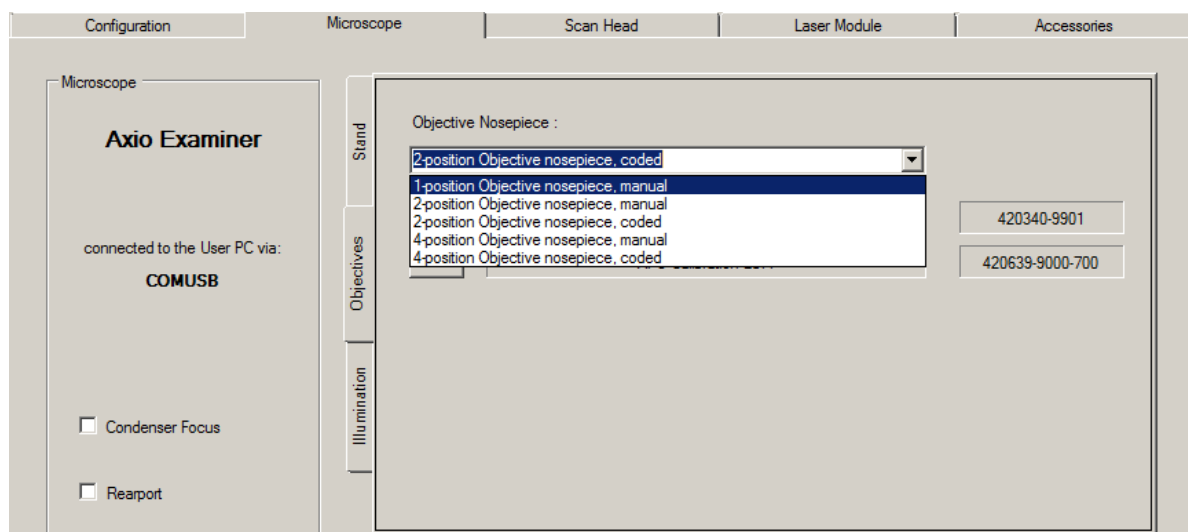


Fig. 16 Configuration tool with Microscope and Objectives tab active for choosing the objective nosepiece representing also the GaAsP nosepiece NDD detector.

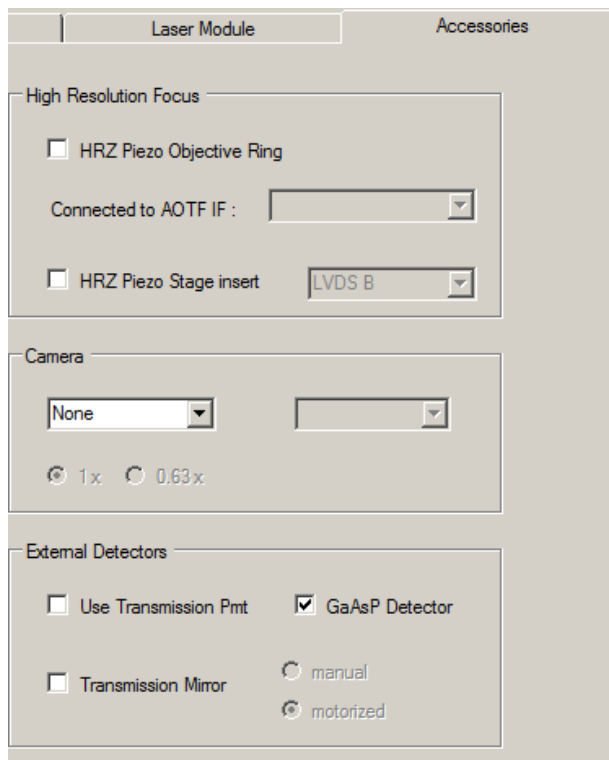


Fig. 17 Configuration tool with Accessories tab active for indicating the GaAsP nosepiece NDD detector in the section for External Detectors at the bottom.

In addition indicate the presence of the GaAsP nosepiece NDD detector in the Accessories tab (Fig. 17).

The GaAsP nosepiece NDD detector sits inside the objective holder.

It is a very light sensitive detector and needs to be handled with great care.

It is suitable to detect the emission signal of a single labeled specimen.

The dichroic filter, which separates excitation and emission light, is put into place for imaging by lowering the lever above the objective clockwise until it stops.

There is an additional short pass laser block filter in front of the detector itself for optimal suppression of the laser light. Both filters are not exchangeable.

How to Use the GaAsP nosepiece NDD Detector:

A. General Instructions for Use


Before using this detector for image acquisition, proceed as follows:

- If standard non-descanned detectors (NDDs) are provided on the microscope, **first** use these to set the optimum acquisition parameters such as laser power, PMT high voltage, filter selection, and the positions of specimen and focus. If no standard NDDs are provided on your system, please use the detectors provided in the scan head for setting these parameters. You should also consider the spectral properties of the filters whether you use NDDs or the scan head detectors. Always start at the surface of the specimen.
- As soon as you remove the GaAsP nosepiece NDD detector from the microscope, please store it in the light-tight box supplied.
- If you follow these instructions, the GaAsP nosepiece NDD detector can be safely used and will give optimum performance.

B. Proper Use of the GaAsP nosepiece NDD Detector for Image Acquisition

It is assumed that you have first used at least the internal detectors for identifying the optimum acquisition parameters (laser power, PMT high voltage, and filter selection, focus and specimen position).

1. Best switch off the room light completely or at least dim it to the least possible level, or screen the specimen space against all external light.
2. Switch off the halogen, X-Cite or HBO lamp, or make sure that the shutters are closed.
3. Deactivate any other laser sources. Diode lasers have to be turned off via the software; all other lasers, when not in use, are switched off or blocked by a shutter in the laser module.
4. Set the power of the multiphoton laser to a minimum level which is smaller than or, at most, equal to the level you used for image acquisition with the scan head detectors or standard NDDs.
5. Activate the GaAsP nosepiece NDD detector via the software (tick the check box). Make sure that the detector high voltage is set to zero.
6. Start image acquisition. Slowly increase the high voltage (detector gain) of the detector, and watch the intensity in the image. With very high voltage, you should essentially see only dark noise. If a lot of noise is visible in the image already with lower voltage, this is probably due to room light or light from other sources. These light sources may not only cause damage to the detector but also greatly impair the quality of the image. Switch these light sources off, or improve the screening of the specimen area. After this, reset the high voltage to zero.
7. If there is nothing but dark noise, manually tilt the color beamsplitter provided right above the objective into the beam path, and slowly increase the high voltage of the detector again, while watching the image. The optimum range of high voltage is about 500 – 800 V. If the signal is too strong, reduce the laser power. If the signal is too weak in the optimum high voltage range, slowly increase the laser power until the image is well balanced.

 If too much light (e.g., room light) hits the GaAsP nosepiece NDD detector, the light is directed onto a light trap, and no signal or a faint signal only, is detected. Stop the scan. Reduce light incidence by screening off ambient light, switching off light sources, or reduce the laser power. Then restart scanning.

CHAPTER 9 CONFOCOR 3

CONTENTS

	Page
9 CONFOCOR 3	3
9.1 Principle of Laser Scanning Microscopy	3
9.1.1 Principle of Fluorescence Correlation Spectroscopy.....	4
9.1.2 Optical Diagram of the ConfoCor 3 and the LSM 710 and LSM 780 Systems (Schematic)...	5
9.1.3 Performance Features of the ConfoCor 3 and the LSM 710 and LSM 780 Systems	6
9.1.3.1 Optical and Mechanical Aspects.....	6
9.1.3.2 Microscope Equipment of the ConfoCor 3 and the LSM 710 and LSM 780 Systems	7
9.1.3.3 Computer Hardware and Software	9
9.2 Starting the Software.....	10
9.3 Main Menu for ConfoCor	11
9.4 Methods.....	13
9.5 Carrier Position	14
9.5.1 X,Y Stage Control.....	14
9.5.2 Z (Focus) Control.....	16
9.6 System Configuration	21
9.6.1 Light Path	21
9.6.1.1 Pinhole	30
9.7 Acquisition.....	35
9.7.1.1 Times.....	35
9.7.1.2 Kinetics.....	37
9.7.1.3 Positions	39
9.8 Processing.....	47
9.8.1 Fit.....	47
9.8.2 Data Handling.....	49
9.9 Models	52
9.9.1 Correlation	52
9.9.2 Model Equations.....	53
9.9.3 Definition of a Model.....	70

9.9.4	PCH.....	78
9.9.5	Formula.....	79
9.10	X-Y-Z Scan.....	80
9.11	Save Info.....	81
9.12	Action Buttons.....	82
9.12.1	Count Rate.....	83
9.12.2	New.....	85
9.12.2.1	Loading Stored Data Files.....	87
9.12.2.2	FCS Correlation.....	88
9.12.2.3	FCS Coincidence.....	101
9.12.2.4	FCS Fit.....	102
9.12.2.5	FCS Print.....	109
9.12.3	XYZ-Scan.....	111
9.12.4	Snap, Start ConfoCor Experiment, Stop.....	114
9.13	Options.....	121
9.13.1	Data.....	121
9.13.1.1	Saving Raw Data During Measurement.....	121
9.13.1.2	Raw Data Formats.....	122
9.13.2	Measure.....	125
9.13.2.1	Move Stage During Measure.....	125
9.13.2.2	Enable Laser Shutter Filter Wheel.....	126
9.13.2.3	Control AOTF Dampening Automatically.....	126
9.13.3	LSM + ConfoCor.....	127
9.13.4	Auto Save.....	133
9.14	Photon Counting Imaging with the ConfoCor 3.....	134
9.14.1	Using APD Detectors for Photon Counting Imaging.....	134
9.14.2	Display of Photon Count Images.....	135
9.14.2.1	The Analog (Grey Value) Display.....	136
9.14.2.2	Counting (Raw Data) Format.....	137
9.15	List of Key Words.....	138

9 CONFOCOR 3

9.1 Principle of Laser Scanning Microscopy

To yield information on their inner structure by conventional transmitted-light microscopy, specimens have to be very thin and translucent; otherwise image definition will be poor. In many cases it is a problem to satisfy these requirements.

The essential considerations have led to trailblazing changes in conventional microscopy and supplied a successful solution to the above problem.

- Unlike the practice of even illumination in conventional microscopy, the LSM technique projects the light of a point light source (a laser) through a high-NA objective onto a certain object plane of interest as a nearly diffraction-limited focus. However, if not for another "trick", the stray light produced outside the object plane, or the fluorescence of fluorescent specimens, would disturb the in-focus image of object point of interest, resulting in a blurred image of poor contrast. The problem therefore is how to capture only the light coming immediately from the object point in focus, while obstructing the light coming from out-of-focus areas of the specimen.
- The light reflected, or the fluorescence light produced, at the focus of the high-NA objective is projected onto a variable pinhole diaphragm by the same objective and a tube lens. The focus inside the specimen and the pinhole are situated at optically conjugate points (**confocal imaging**). The decisive advantage of this arrangement is the fact that essentially no other light than that coming from the object plane of interest can pass the narrow pinhole and be registered by a detector. Unwanted light coming from other specimen areas is focused outside the pinhole, which passes only a small fraction of it. The smaller the pinhole, the less stray light or fluorescence from out-of-focus areas will get on the detector. The image point thus generated is largely free from blur caused by unwanted light.
- In order to obtain an image of the selected object plane as a whole, it is necessary to scan the object plane in a point-by-point, line-by-line raster by means of an XY light deflection system. The detectors - as a rule, photomultipliers - convert the optical information into electric signals. This allows the image of any object plane to be generated and stored within less than a second. By a defined focusing (Z axis) movement it is possible to look at any object plane of interest. By scanning a succession of object planes in a specimen, a stack of slice images can be produced.

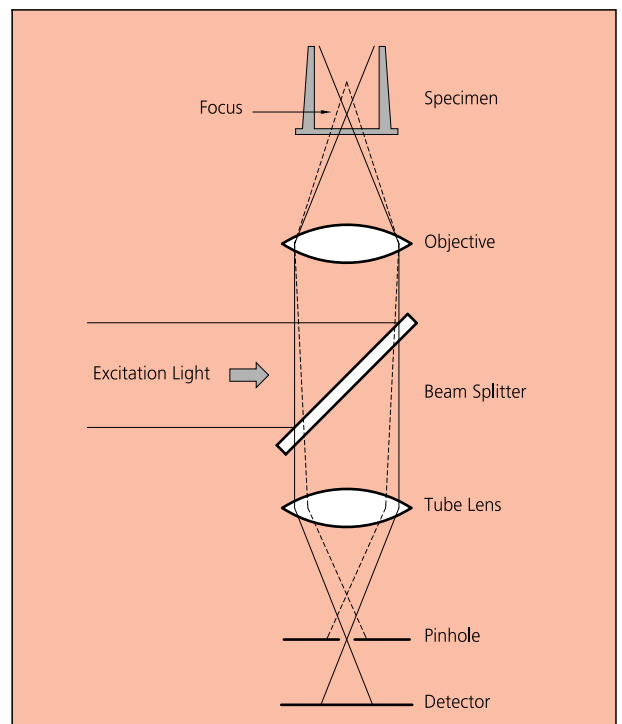


Fig. 1 Principle of confocal imaging

This way, the LSM technique in conjunction with ICS optics (Infinity Color-Corrected System) has brought decisive improvements over conventional microscopy in terms of resolving power and confocal depth contrast: **Object features in the order of 0.2 μm can be resolved, and height differences of less than 0.1 μm made visible, without the use of interference methods.**

9.1.1 Principle of Fluorescence Correlation Spectroscopy

Fluorescence Correlation Spectroscopy (FCS) analyzes the diffusion time of molecules and their differences if they have bound together. This is done by fluctuation analysis of fluorescence-labeled molecules within a well defined volume element. In most experiments, Brownian motion drives the fluctuation. The volume element is the confocal volume defined by the excitation spot of a well focused laser beam and the selected emission region defined by the properly aligned pinhole of the detection optics (see Fig. 1).

As such, the setup is the same as for a Laser-Scanning Microscope (LSM), but in the latter we are not interested in the fluctuations but in the average intensity. As a matter of fact, what is the signal in FCS is noise in the LSM. Since the fluctuations are more pronounced, if less molecules are in the volume, FCS requires little molecule numbers (1-10). Whereas LSM is a scanning technique, FCS uses the beam is parked in one spot.

The fluctuations are analyzed by treating the measured photon counts with mathematical methods called correlation functions (see Fig. 2). The amplitude of the function is inverse proportional to the molecule number and the decay time gives the residence time of the molecule in the confocal volume and hence its diffusion time. If the two interacting molecules are of different size, only the smaller one has to be labeled using fluorescent dyes. This method is called auto-correlation. In this case the total auto-correlation is the sum of the two different species. If the diffusion constants of both partners are similar, they are both labeled with different dyes and cross-correlation is used. Often, photophysical processes like triplet states impinge on the correlation function, but can be accommodated in the model. Then the total correlation is the product of the single processes.

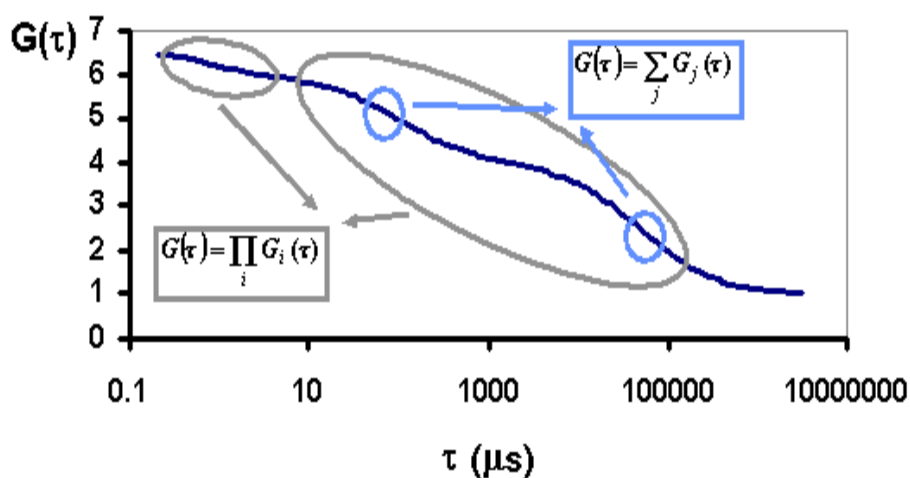


Fig. 2 Correlation functions

Fig. 2 shows a correlation curve for a two component translational diffusion with triplet. The two components can be separated on behalf of their diffusion time (circles). Note that the contribution of the two components add up, whereas the contribution of the total diffusion process and the triplet multiply to obtain the total correlation.

Because of the tiny size of the confocal volume and its nature, the measurement can be carried out, in principle, in every area that is reachable by light and that is not smaller than an *Escherichia coli* bacterium (approximately 0.2 fl). In particular, measurements can be done inside living cells or on cell membranes. In order to be able to place the measurement volume at its proper place, it is advantageous to combine FCS with powerful light microscopy, particularly a confocal LSM.

9.1.2 Optical Diagram of the ConfoCor 3 and the LSM 710 and LSM 780 Systems (Schematic)

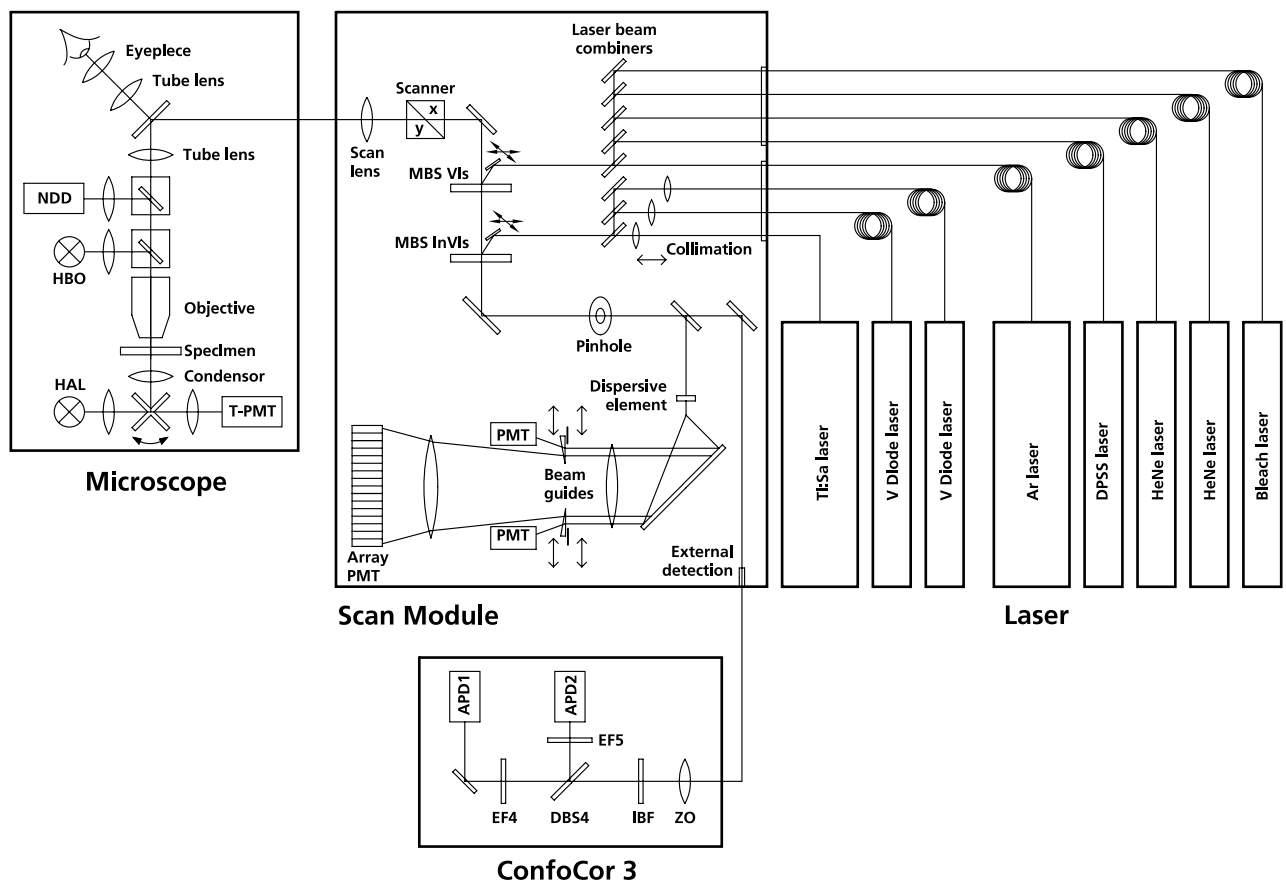


Fig. 3 Optical path, schematic (3-channel configuration)

APD	Avalanche photodiode	MBS	Main Beam Splitter
DBS	Dichroic Beam Splitter	NDD	Non-Descanned Detector
EF	Emission Filter	PMT	Photomultiplier
HAL	Halogen Lamp	T-PMT	Transmission-Photomultiplier
HBO	Mercury Vapor Short-Arc Lamp	ZO	Zoom Optics
IBF	Infrared Blocking Filter		

The diagram above is a schematic representation of the LSM 710 / LSM 780-ConfoCor 3 system.

Laser light is focused onto the specimen through an objective in a diffraction-limited mode. Light emitted at the focal plane and at planes below and above it is directed via an XY scanner onto a main dichroic beam splitter (MDBS), which separates the emissions from the excitation light. The fluorescences are separated from each other by a series of dichroic beam splitters (DBS1 ... maximally DBS4) and directed to individual photomultipliers (PMT1 ... maximally PMT3) or via Channel 4 into the ConfoCor 3 module. Here light passes through block filters for NLO light (if applicable), and is directed via a dichroic beam splitter (DBS 5) to avalanche photodiodes (APD1 ... maximally APD2) or GaAsP (GaAsP1 ... maximally GaAsP2) detectors. The pinholes (VP) block all out of focus light, whereas emission filters (EF) are used to select a specific spectrum of the emitted light and to suppress any remaining excitation light.

9.1.3 Performance Features of the ConfoCor 3 and the LSM 710 and LSM 780 Systems

9.1.3.1 Optical and Mechanical Aspects

The highly integrated system design makes for the shortest possible optical paths, top-grade optical precision and high stability. The compact scanning module can be fitted to an inverted microscope in less than three minutes. The ConfoCor 3 can only be mounted in combination with the LSM 710 / LSM 780 scanning module to the side port of the Axio Observer.Z1 microscope stand.

The spectral range available extends from the UV to the IR region.

For the VIS (visible-light) Laser Module, the user can select from up to six lasers with wavelengths of 633, 594, 561, 543, 514, 488, 477, 458 and 405 nm. The UV Laser Module provides wavelengths of 351 and 364 nm. A Ti:Sa Laser provides pulsed laser light from 680 to 1080 nm for Multiphoton imaging (NLO). Coupling of the laser light is through polarization-preserving single-mode optical fibers. One variable beam collimator each for the UV or NLO and visible ranges provides optimum adaptation of the respective laser wavelength to the objective used and, thus, optimum correction for Z aberrations.

Acousto-optical tunable filters (AOTF) adjust the necessary brightness for up to 8 laser lines within microseconds.

A monitor diode permanently registers the laser output; it can be used for the on-line checking of the intensity of the exciting light. This check is also possible selectively for the different wavelengths if a line selection filter is inserted.

The three internal image acquisition channels, usable for reflection or fluorescence, and an additional transmitted-light channel are ideal for the investigation of multiple fluorescence specimens. The ConfoCor 3 is attached to the fourth channel. The ConfoCor 3 comes with two detector types: Gallenium Arsenide Phosphide detectors (GaAsP) or avalanche photodiodes (APD). The APDs will deliver a TTL pulse, the GaAsP detectors deliver TTL pulse, NIM pulse and an analogue signal. Separately in each of the four channels, the diameters of the pinholes and their XY positions can be optimized, and the desired emission filter placed into the beam path, by servo-motor control. In the case of pinhole VP1, this adjustment also includes positioning along Z. In the simultaneous registration of multiple fluorescence, identical optical sections can be obtained in each confocal channel. This is of importance, e.g., with the FISH method (fluorescence in-situ hybridization) used for genome analysis in cytogenetic studies.

The microscope's transmitted-light channel is equipped with a photomultiplier, too. It is therefore possible to superimpose a multiple fluorescence image on a brightfield, differential interference or phase image.

A fiber-optic cable connection to external special detectors, such as cooled PMTs or spectrometers, is not available if the ConfoCor 3 is attached.

In addition to the emission filters for all standard and special applications, available in motor-controlled filter wheels, the user can easily install his own emission filters in two of the channels. In the ConfoCor 3 all filter wheels can be exchanged by push and click.

The high-NA C-APOCHROMAT objectives specially developed for the LSM technique reach the physical limit in resolving power, and can be used throughout the 380...900 nm spectral range with the same high quality, producing brilliant images. Note, for fluorescence correlation spectroscopy the C-APOCHROMAT objectives are highly recommended.

A two-mirror scanner system, controlled by a real time electronics, offers several advantages. The large deflection angle of the scanning mirrors allows a wide area to be scanned. With a 1.25× objective, the object area scanned is 10 × 10 mm². The scanning field size can be freely selected between 4 × 1 and 2048 × 2048 pixels.

It is possible to rotate the XY scanning field through 360° and carry out XY scans without having to rotate the specimen itself under laser radiation load.

For ConfoCor 3 operation, the mirrors will be parked.

Selection of the specimen detail of interest for zooming is fast and convenient, and the zoomed image is automatically centered. This saves the job of specimen centration with the microscope stage.

Using a bi-directional scanning facility will double the scanning rate to approx. 5 frames/sec (at 512 × 512 pixels); if two different laser wavelengths are used for the two scanning directions (wavelength 1 for left-to-right, and wavelength 2 for right-to-left scanning), two fluorochrome dyes can be viewed and documented in a quasi-simultaneous mode. This will prevent cross talk between detection channels.

9.1.3.2 Microscope Equipment of the ConfoCor 3 and the LSM 710 and LSM 780 Systems

The LSM 710 and LSM 780 systems are equipped either with the inverted Axio Observer.Z1 SP microscope required in combination with the ConfoCor 3.

Only the differences from the delivered operating manual "Axio Observer.Z1" will be explained here.

(1) Stand

a) The motorized objective nosepiece 5× H DIC is firmly fixed to the stand, where no operating elements can be found for the nosepiece. Operation will be performed via LSM software control. The "Restriction of the nosepiece height to protect the objectives during motorized objective change" is inactivated. The nosepiece will be moved down automatically before each motorized objective change.

b) The reflector mount is motorized and provided with the Axio Observer.Z1 reflector turret. The reflector turret has six positions: One transmitting light position, which is identical to the LSM position, and five further positions for fluorescence filter sets (reflector modules). If you want to use more than five conventional fluorescence filter sets, it is advisable to use a further reflector turret. When changing the reflector turret position you must make sure that the turret will click into position, since otherwise the image area will be cut.

c) The stand has a motorized focusing drive (fine coarse). Sensitivity of the focusing drive is adjusted to the delivered objectives by the manufacturer. If you want to use other objectives, sensitivity and parfocality can be adjusted via the Axioset program.

d) The stand features an integrated power supply for the internal motors and stand electronics. The power supply can be switched at the external power supply unit for the microscope. External power supply units will be used for the mercury vapor short arc lamp or the X-Cite 120 fiber coupled lamp.

e) The analyzer slider for conventional DIC methods will be operated from the right side and is located just below the nosepiece.

When the rod is pushed in, the analyzer is located in the beam path. In the LSM-mode, the analyzer must **not** be located in the beam path, and the analyzer rod must be pulled out.

(2) Specimen stages and fine focus drives

a) Mechanical stage

The stage with coaxial drive must be mounted on the right side of the stand.

b) Scanning stage

c) Piezo objective focus drive

(3) Transmitted-light illumination

a) The illuminator support contains a security circuit which activates a shutter preventing laser light from reaching the stand when the support is moved to the back. A complementary shutter built in the stand prevents laser light from reaching the eyepieces during the scanning mode.

b) The illuminator support is equipped with a rotary polarizer. The Axio Observer.Z1 description contains the adjustment for the DIC mode during conventional observation.

For scanning in the transmitted-light DIC mode, the polarizer in the transmitted light support works like an analyzer and must be adjusted in such a manner that direct laser light will be blocked.

The conventional analyzer slider in the stand must not be located in the beam path because the laser light is already polarized.

c) A fully motorized, LSM software-controlled switching mirror is mounted on the illuminator support. Alternatively, the light is directed to the LSM transmitted-light detector or enables conventional transmitted-light observation.

d) The focusing screen for conventional transmitted-light is located in a support in front of the halogen lamp housing.

e) Further information on the halogen lamp and the condensers is provided in the Axio Observer.Z1 operating manual.

(4) Reflected light fluorescence

With the exception of the reflector slider, all the Axio Observer.Z1 fluorescence accessories can be used.

Further information is provided in the Axio Observer.Z1 operation manual.

(5) Imaging optics

Optovar sliders cannot be used.

The analyzer for the conventional DIC mode will be operated from the right side and is located just below the nosepiece.

Use of sliders with auxiliary objects (473704/14-0000-000) is not possible.

(6) Photo equipment

The stand does not feature an integrated SLR-port, but microscope cameras as described in the Axio Observer.Z1 and LSM 710 and LSM 780 systems operation manual can be used.

(7) TV adaptation

The TV port at the side and the tubes can be used as described in the Axio Observer.Z1 operation manual.

The TV interface side port can be used with TV adapters 60 N or LSM adapters.

9.1.3.3 Computer Hardware and Software

The LSM 710 and LSM 780 systems-ConfoCor 3 are controlled via a standard high-end Pentium / Xeon PC. Linking to the electronic control system is made via Gigabit Ethernet interface. The PC comes with the WINDOWS XP / VISTA operating system.

The instrument is fully motorized, permitting fast change-over between methods as well as automatic operation. Parameters once set or complex examination sequences once established can be saved and reproduced; therefore, complete application programs can be loaded and performed by pushbutton control.

The software of the LSM 710 and LSM 780 systems and ConfoCor 3 has two levels. On the simple operator interface level, a result will be achieved after a few prompts; graphical prompting of the user in conjunction with automatic setting of many parameters is an ideal tool for daily routine jobs. The expert level offers perfect facilities for individual settings of functions and parameters.

Conversion of the light signals into a digital image is effected by means of four 12-bit A/D converters, each of which can generate 4096 brightness levels.

The software provides an enormously wide range of image processing functions, including all standard 2D / 3D (stereo, projection) functions identical to sophisticated 3D reconstruction capabilities (surface and alpha rendering), digital processing of voxels and 3D measurement functions (surface areas, volumes).

As all files and images are recorded in MS Access databases, elegant image database editing is just as easy as transferring the records to other programs.

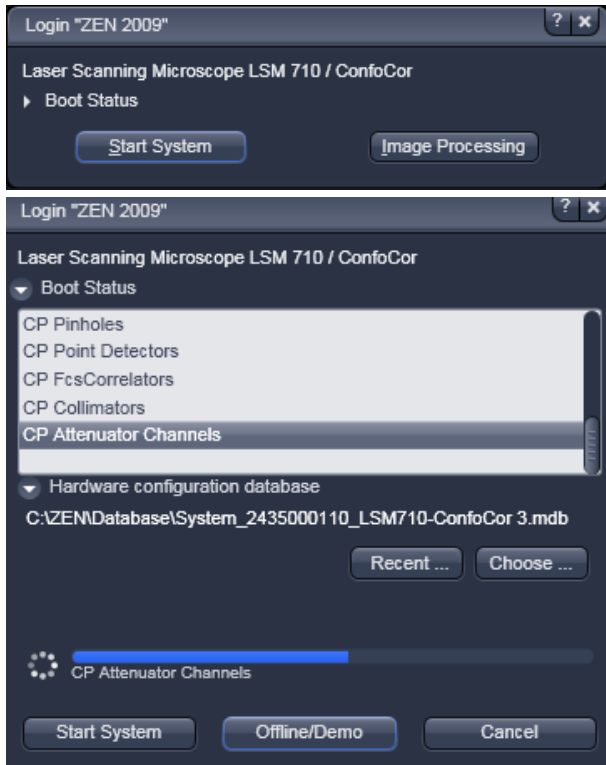


Fig. 4 Starting the ZEN software

9.2 Starting the Software

- To start the software double click the ZEN icon on your desktop or select ZEN in Carl-Zeiss ZEN from the Windows Programs menu.

- The "Login Zeiss Imaging" switchboard will appear (Fig. 4).

You can boot for online, offline and image processing mode or close the switchboard without booting. If you want to boot for offline and image processing mode or cancel the booting process, the **Boot Status** must be open. Choose:

- **Offline/Demo** for data analysis and simulation. This option should be chosen when working on an offline station and if you want to test functionalities of the system. The progress of the boot process will be displayed by the blue time tab. The single components will be listed, which are checked during the boot process.
- **Start System** for system control, data acquisition and analysis. The progress of the boot process will be displayed by the blue time tab. During booting the status of the system will be displayed in the **Boot Status** window and the single components will be listed which have been or are currently being checked during the boot process.
- **Image Processing** for data analysis only.
- **Cancel** to abort the booting process and to leave the switchboard. Note that the Cancel button will appear only if **Start System** or **Offline/Demo** was selected.



Fig. 5 Recent databases

- You can leave the software by choosing the **File** menu from the **Main Tool** area and selecting **exit**.
- You can choose before booting the database if you open the **Hardware configuration database** window and pressing the **Choose...** button. Select a database from the Explorer window. If **Recent...** is pressed the last couple of databases that were in use will be displayed (Fig. 5), from which one can select the appropriate one.

9.3 Main Menu for ConfoCor

The major functions can be selected from the Toolgroup **ConfoCor** (see Fig. 6) in the tab **Acquisition**.

For opening saved files the **File** button from the **Menu** Tab has to be used.

The ConfoCor Toolgroup is divided in (grey) Action Buttons and (blue) Tool Tabs.



Fig. 6 ConfoCor Toolgroup



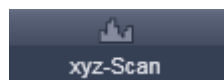
New Document
action button

Opens a new FCS window document in a new container within the Center Screen Area. If active, all new data will be added to the document. Old data can be deposited in the new document by drag and drop from stored documents.



Countrate action
button

Opens the **Countrate** window, which displays counts per second (CR), correlation amplitude (G(0)) and counts per molecule per second (CPM)



xyz-Scan action
button

Will trigger a Scan in x, y, z, xz and yz as defined in the **X-Y-Z Scan** Tool.



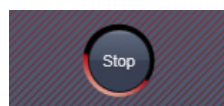
Snap action button

Triggers one measurement according to the settings at the highlighted position from a set of defined positions.



Start ConfoCor Experiment action
button

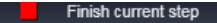








Triggers measurements according to the settings at all defined positions.



Stop action button

Will end an active measurement. Data will be available to store up to the end point.

Note this button only appears if the **Start ConfoCor Experiment** button was pressed and an active measurement was triggered.

	Finish current step action button	Will end an active measurement. Data will be available to store up to the end point. Note that this button replaces the Start ConfoCor Experiment button, if the latter was pressed.
	Methods tool	Selects a pre-defined method to be used in the measurements.
	Carrier Position tool	Define and orient a sample carrier in x, y and z.
	System configuration tool	Define the light path, laser lines and pinhole position
	Acquisition tool	Set measurement times, kinetics and measurement positions
	Processing tool	Set up fit model and correlation parameters to be used in the experiment
	Models tool	Define fit models for data analysis
	X-Y-Z Scan tool	Define scan ranges in x, y and z to be used in the action button xyz-Scan
	Save Info tool	Display of Meta data; enter experimental infod; document data

9.4 Methods

The **Methods** tool lists all existing measure methods for selection or deletion.

- Click on the **Methods** tool button.
 - This opens the **Method** tool box (see Fig. 7). Another click will close the window again. Scroll tabs will allow to view all the contents. In the undocked state the window size can be accommodated to fit the requirements by pulling the window sites.

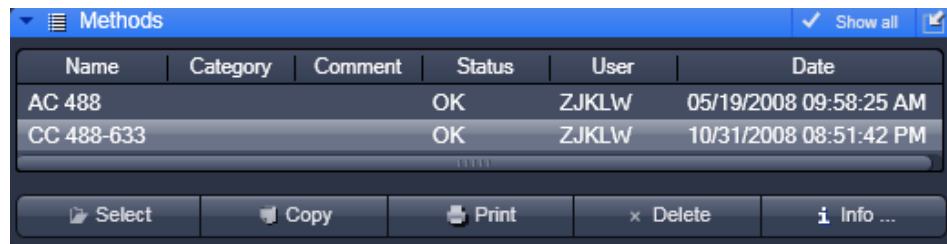


Fig. 7 Methods tool box

Please note that **Category**, **Comment** and **Status** are only displayed in **show all** mode.

- Click on the **Method Information** tab to display a detailed description of the highlighted method including name, comments, configurations and parameter settings (Fig. 8). Click a second time to close the information window.
- You can select the analysis method you want to use by highlighting the corresponding entry from the list with a single click and pressing the **Select** button.

 All parameters will load with this method.

- The **Copy** button will copy the content of the **Method Information** window into the clipboard.
- The **Print** button opens the **Print Setup** window. Set the print parameters and start the print function by clicking **Ok**. The **Print Setup** window will be closed automatically and the content of the **Method Information** window will be printed as a hardcopy.
- The **Delete** button allows you to delete a method from the database. To do so, highlight the method you want to remove and then click the **Delete** button. A **Delete Method** window will appear requesting confirmation of this action. Press **Yes** to delete the method from the data base, **No** to keep the method.

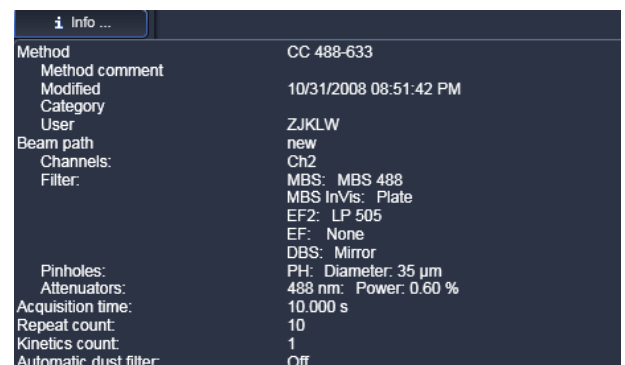


Fig. 8 Method tool box with method Information window opened



Fig. 9 Carrier Position tool box

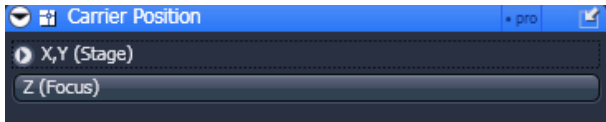


Fig. 10 Carrier Position tool box for ConfoCor 2

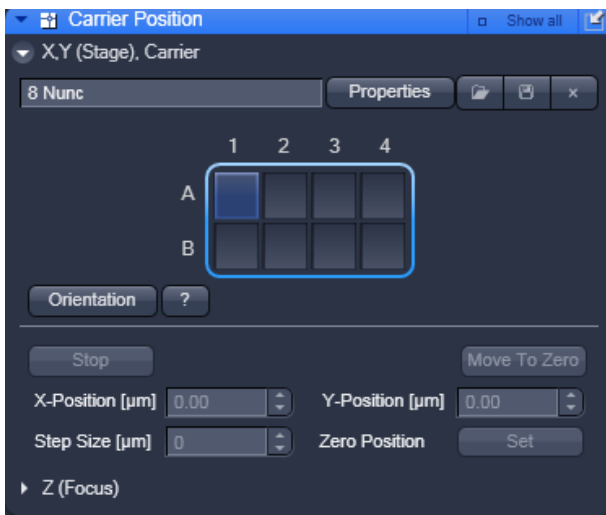


Fig. 11 Carrier Position in pro mode with Speed settings and Marks opened

9.5 Carrier Position

The **Carrier position** tool allows the definition and orientation of a sample carrier, so that single wells can be approached automatically. It also allows the z-focus to be positioned into the solution.

- Press the **Carrier Position** tool tab to open the **Carrier Position** tool box (Fig. 9). Press the tab again to close the tool box. You have the following options:

- X,Y (Stage): Positioning in x and y
- Z (Focus): Positioning in z

- ☞ For ConfoCor 2 the **Z(focus)** is replaced by the **Camera** tool bar (Fig. 10).

9.5.1 X,Y Stage Control


- Press the X,Y (Stage) tab to open the (X,Y) Stage tool box (Fig. 11). Press the tab again to close the box.

Selection of a sample carrier

From the **Sample Carrier** dropdown menu box you can select a pre-defined carrier. This will display the sample carrier in the **Orientation** box.

- If you want to edit a pre-existing carrier or want to create a new one press the **Properties** button (Fig. 11) to open the **Properties** window.
- Enter the number of chambers and the distance (mm) between the chambers in the appropriate Column and Row input boxes.
- To orient the sample carrier in x and y click on the Orientation button in the X, Y (Stage) panel.

- Position the center of one chamber over the center of the objective by clicking the arrow keys of the compass rose with the mouse or by using the control panel's joystick (if available).
- Click on the corresponding chamber in the Orientation window.
 - This chamber will be highlighted. When you have finished the **Orientation** automatically deactivates. The stage is now oriented.

- Now you can move any chamber into the measurement position by clicking the appropriate field on the sample carrier.
 - The selected chamber is then automatically approached via the motorized microscope stage. When the defined position has been reached, the position of the chamber is displayed in the lower left corner in the **Positions** panel and is highlighted in blue.
-  By pressing the **Help** button (? question mark icon) button, a **Help** window appears explaining the work flow for orienting the Carrier.

Stage movement

The **Compass Rose** allows you to move the scanning stage in the direction of the arrows that will become visible, when the mouse moves over a section (see Fig. 11).

Clicking the arrow of the inner circle will cause the stage to move with normal speed. If you press the double arrow of the outer section the stage will move with fast speed. The speeds are set in **Speed pull-down menu** for the inner and outer ring (Fig. 12). Settings become only available in the **pro** mode. **You can select between Speed 1, 2 and 3.**

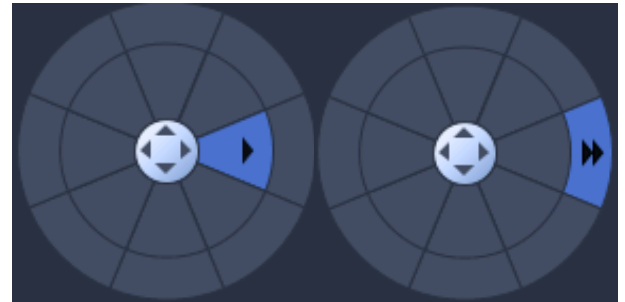



Fig. 12 **Compass rose with mouse pointing to an inner (left) and outer (right) section**

You can define the step size by using the tabs of the **Step Size [µm]** box or typing a number. You can move with two speeds, fast with the outer rose and slow with the inner rose. If the carrier was moved by the compass rose or the joystick, the orientation will be lost.

The **X-Position [µm]** and **Y-Position [µm]** boxes display the current relative x and y positions of the stage. If you type in numbers in the boxes the first click on the compass rose will move the stage to this defined position. Further clicks will move the stage in the direction of the arrow pressed with the step size and speed selected.

You can stop the stage from moving to a defined position by pressing the **Stop** button. In this case the orientation of the carrier will be lost.

If the **Zero Position Set** button is pressed, the stage will be zeroed to the current position. You can move to the zero position by pressing the **Move To Zero** button.

-  If the carrier is not oriented or positions are defined out of the range of the carrier, the stage might move the sample carrier out of the objective field.

Marks is only available in **pro** mode. It allows you to define positions in an image. You can give a marked position a name by typing a name in the **Marks display** box. You can move to a marked position by stage by selecting it from the drop down menu and pressing the **Move To** button. You can remove a marked position by loading it and pressing the **Remove** button. And you can remove all marked positions by pressing the **Remove All** button.

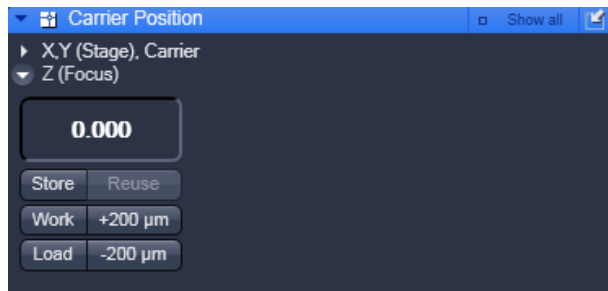



Fig. 13 Z (Focus) panel

9.5.2 Z (Focus) Control

The functions of the **Z (Focus)** tool allows you to position the focus in Z direction.

- Press the **Z (Focus)** tool tab to open the **Z (Focus)** tool box (Fig. 13). Press anywhere outside the window to close the tool box.

 If the LSM was used for scanning, light will only be directed to the CCD camera once an FCS application was triggered, even if laser button is in the "on" position.

The following functions are available:

Laser button (laser warning icon): Switches selected laser line illumination on the sample on / off.

Z-Position display field: Displays the current Z position.

Store button: Stores the current Z position.

Reuse button: Moves the stage / nose piece to the stored Z position.

Work button: Moves the stage / nosepiece back to the Work position. This is the position last set before the **Load** button was pressed.

Load button: Lowers the stage / nosepiece to a default position make it easier for you to change the sample carrier (or objective).

+200 µm button: Moves the Z drive for +200 µm per mouse click upwards.

-200 µm button: Moves the Z drive for -200 µm per mouse click downwards.

 The Z-position stored by activation of the **Store** button is a relative parameter and is only valid during the current session. Accordingly, this position can be approached in a defined way only during this session via **Reuse**.


If the sample is just a solution without structure, one cannot "focus" the instrument by looking at sample features. Cover slip reflection has to be used instead to find the glass- / solution interface. The position of the glass surfaces is detected most conveniently via line scanning.

Proceed as follows:

- Make sure that the front lens of the water immersion objective is wetted by a drop of water. Use fluorescence-free double-distilled water, since otherwise the immersion water will cause background fluorescence and deteriorate the correlation signal.
- Choose a chamber by clicking on one well in the **X, Y (Stage)** panel of the **Sample Carrier** tool.
- Set up a beam path in the LSM **Light Path** tool (Fig. 14).

Convenient settings are:

- 488 nm line at 50 % tube current and 5 % AOTF
- MBS T80/R20 major dichroic beam splitter for Visible light
- Plate major dichroic beam splitter for Invisible light
- None for side port systems, Rear for rear port systems <t the reflector position
- Reflection check box activated
- Appropriate spectral band in the detector channel to detect the reflected excitation light, for example 420 – 650 nm for 488 nm light

 Do not use the APD detectors in the reflected mode to find the coverglass surface. They might be deteriorate due to high light intensity and will switch off due to overload.

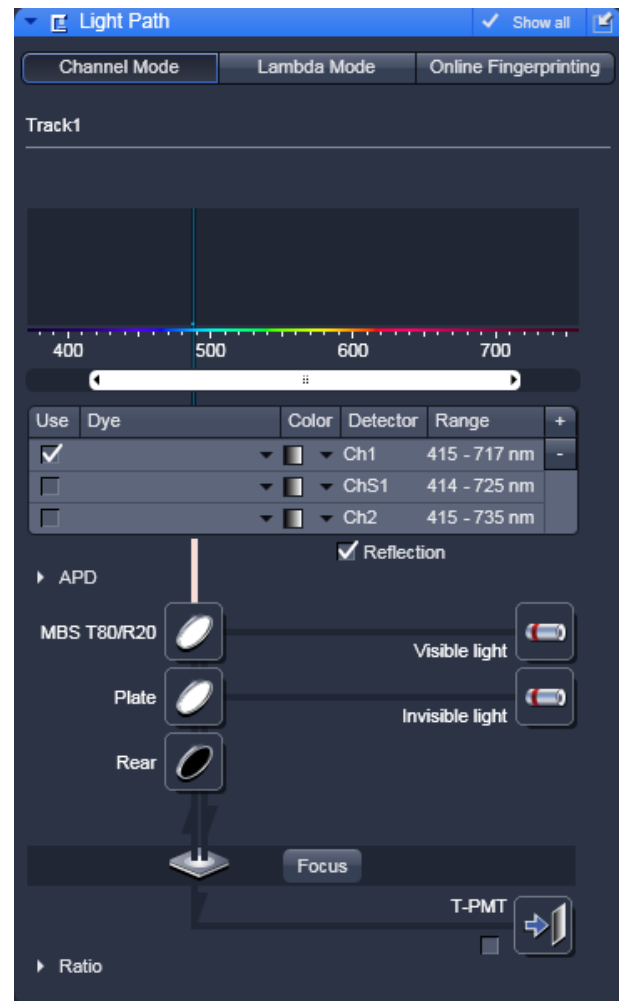


Fig. 14 Beam path configuration for finding glass reflection



- Set up scan mode in the LSM **Acquisition Mode** tool (Fig. 15). Choose **Line** scan, highest Scan speed, 512 pixels and **Zoom 1** for convenience.
- Set up scan control in the LSM **Channels** tool (Fig. 16). Open Pinhole to maximum. Set detector gain between 200 and 300, and laser power to 2 %.

Fig. 15 Image settings for line scan mode

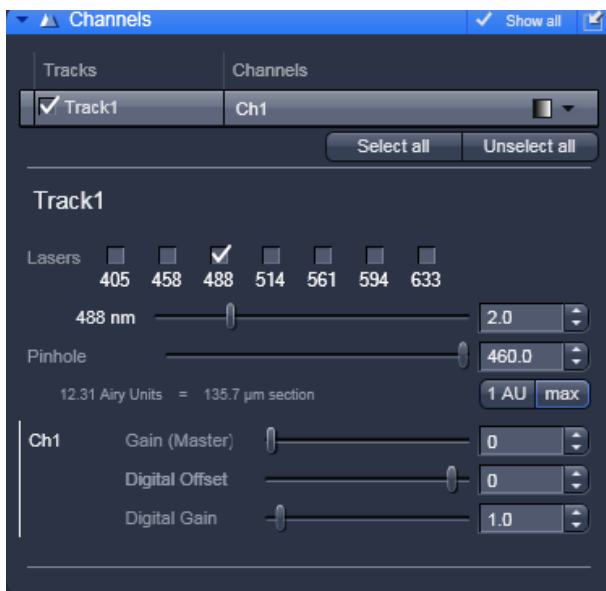


Fig. 16 Channel settings for finding glass reflection

- Press **Continuous** to start a continuous scan. Press the **Line Scan** register (Fig. 17).
- The diagram (Fig. 18) shows a line with a bump, which is the result of reflected light on the optical axis not focused yet on the lower glass surface. You might adjust the line to lower or higher values by altering the gain or laser power.
- Move the objective cautiously upward by turning the Z focus knob of the microscope stand. A lens moving upward will be indicated by increasing numbers in the position field of the **Z (Focus)** panel window.
- If the focus position approaches the lower cover slip surface, the position of the line will shift to higher values (Fig. 19).

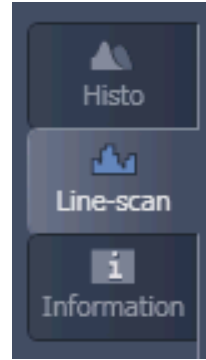


Fig. 17 Selection of Line Scan diagram

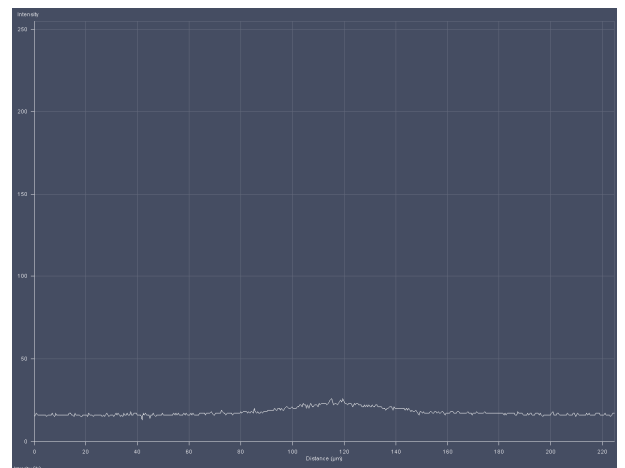


Fig. 18 Selection of Line Scan diagram

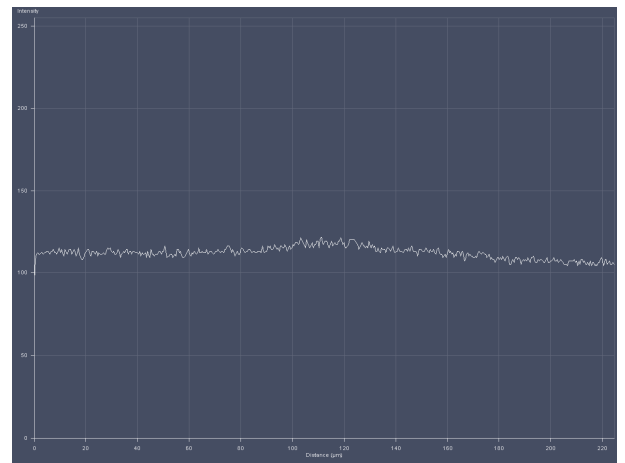


Fig. 19 Line diagram near the lower cover slip surface

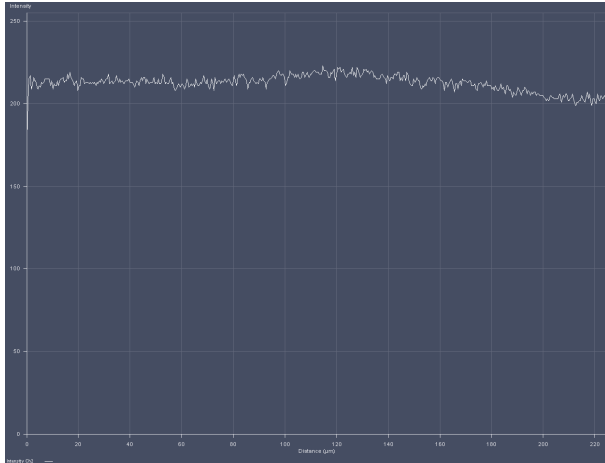


Fig. 20 Line diagram at lower cover slip surface

- Continue cautiously moving upwards. The line position will reach its maximum (Fig. 20).

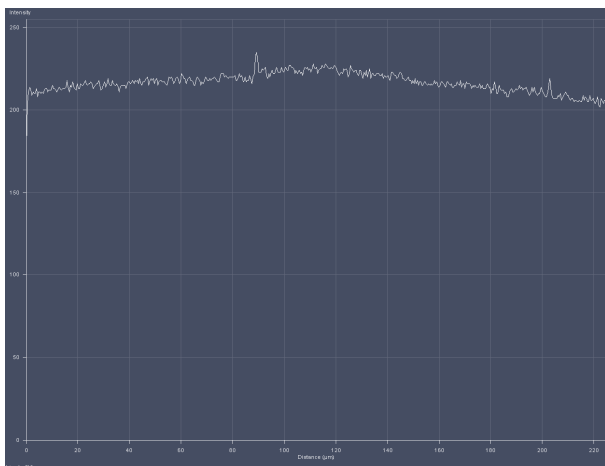


Fig. 21 Line diagram at upper cover slip surface

- Having cautiously moved over a short distance the line position will decline again to a minimum and then rise again to a second maximum (Fig. 21), which corresponds to the upper cover slip surface.
- Store the reached position using the **Store** button.
- Now you can position the detection volume into the sample in a well-defined way:
If you use one of the C-Apochromat water immersion objectives, position the detection volume 150 - 200 µm deep into the sample to get rid of disturbing interface effects. The easiest way of doing this is by clicking the **+200 µm** button.

9.6 System Configuration

In the **System Configuration** tab you will be able to define the beam path of your experiment (setting dichroic beam splitters and filters as well as laser lines), to adjust the pinhole size and its optimal position.

- Click on the tab **System Configuration** to activate the panel (Fig. 22). Click on any other tab to leave the panel. You have two options:
 - **Light Path** to configure the beam path
 - **Pinhole** to adjust the pinhole

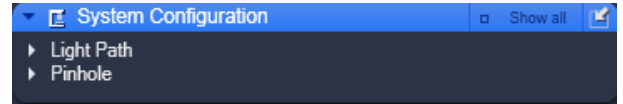


Fig. 22 The System Configuration tool box

9.6.1 Light Path

The **Light Path** panel allows new / existing beam path configurations to be created / edited and saved. The **Delete** function enables you to delete existing beam paths.


- Click on the **Light Path** tab to open the **Light Path** configuration panel (Fig. 23). Click on any other register to leave the panel.

The display "2 Channel Module" indicates that the ConfoCor3 with its two APDs is used and that the fluorescence light is automatically directed to this module.

(1) Saving and deleting beam paths

You can save a beam path by typing in a memorable name within the drop down menu selection box and pressing the **Save** button (floppy disc icon). If you save a beam path under the existing name you will be prompted to confirm overwriting the old configuration. Press **Yes** to overwrite, **No** to keep the old configuration.

You can delete a beam path by selecting it from the drop down menu and pressing the **Delete** (cross icon) button.

 Note, before saving an altered beam path a pinhole alignment should be performed. Pinhole positions will then be linked to the selected beam path and called up whenever that beam path is selected later.

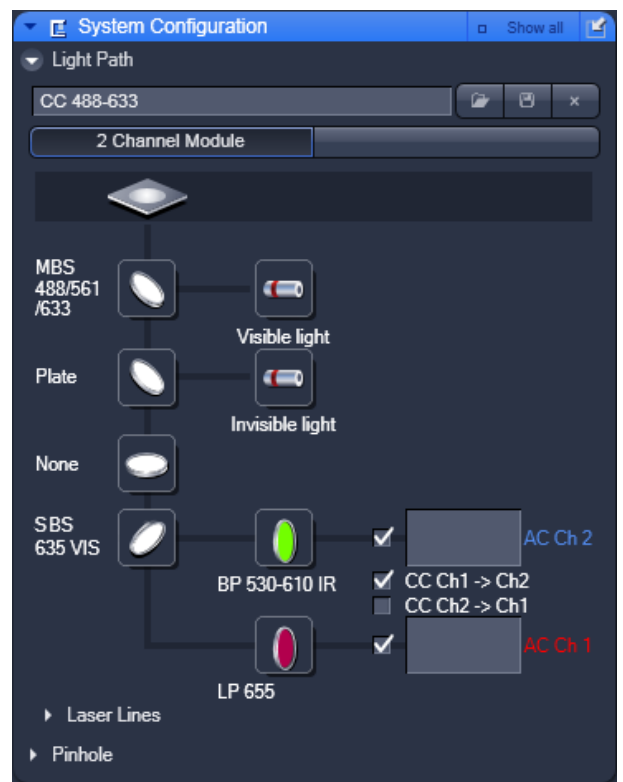


Fig. 23 System Configuration tab - Light Path panel opened for the "2 Channel Module" ConfoCor 3

(2) Loading a predefined beam path

You can select a saved beam path configuration by the drop down menu. The selected beam path will than be loaded and shown with its settings in the displayed diagram. You can alter the beam path if required.

Procedure to load and reconfigure an existing beam path:

- Select a corresponding beam path from the **Light Path** drop down menu list box.
- Change settings as required.
- Save the configuration under the old name to overwrite the existing configuration or under a new name to keep the old configuration.

(3) Define a new beam path

A new light path is defined by choosing the appropriate filters, dichroics and laser lines in the **Light Path** diagram. From top to bottom you have the following dichroics and filters available:

Selection of dichroics and filters

Main dichroic beam splitter (MBS):

The MBS reflects the specified laser lines and allows the resulting fluorescence spectrum to pass through.

Note that the MBS is from the LSM module for the ConfoCor 3, but within the ConfoCor unit in the ConfoCor 2. The MBS is positioned in a 10° angle to the incident beam.

- Click on the MBS icon to open a list of dichroics (Fig. 24).
- Select the appropriate one by a mouse click.
- Close the list by clicking the icon again.
- You have two major beam splitters, one for the Visible light and one of the Invisible light (if applicable). A plate should be placed in the dichroic that will not be used. If the system is not equipped with a violet laser line, the **Invisible light** major beam splitter is not available.

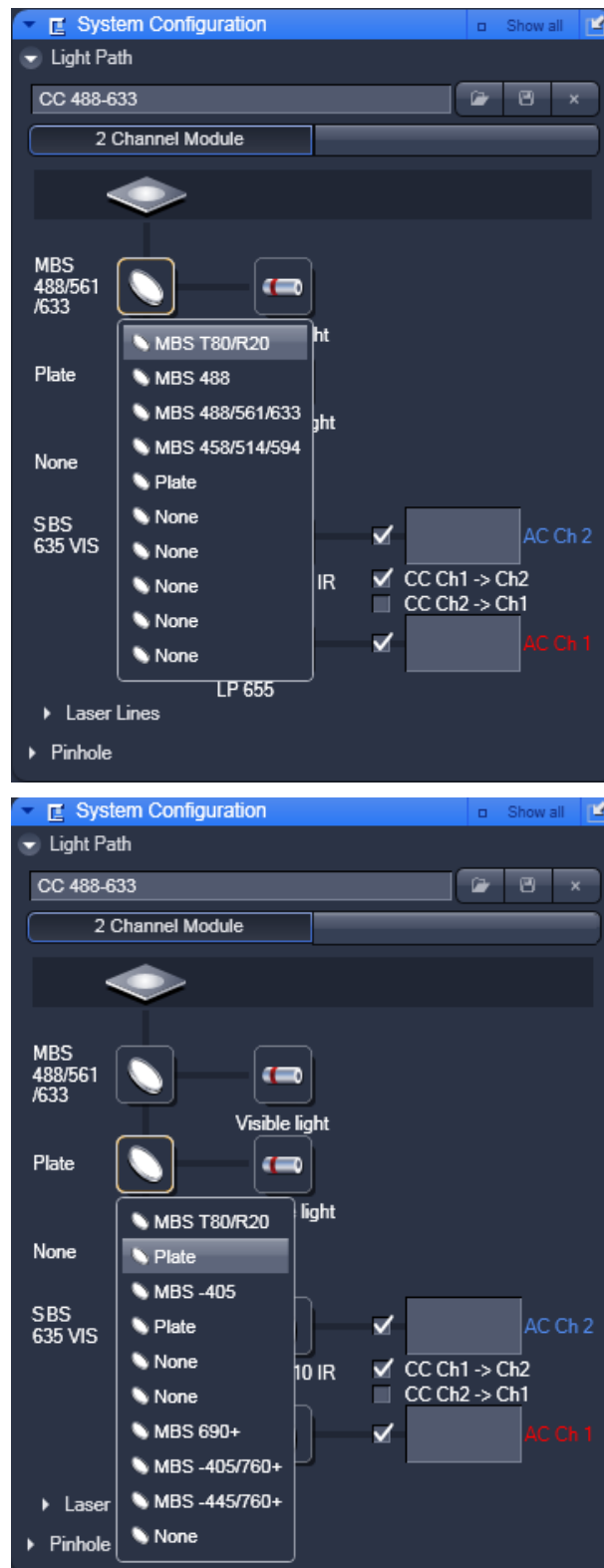


Fig. 24 System Configuration tab - Light Path panel with MBS Vis (upper panel) and Invis (lower panel) dichroics list

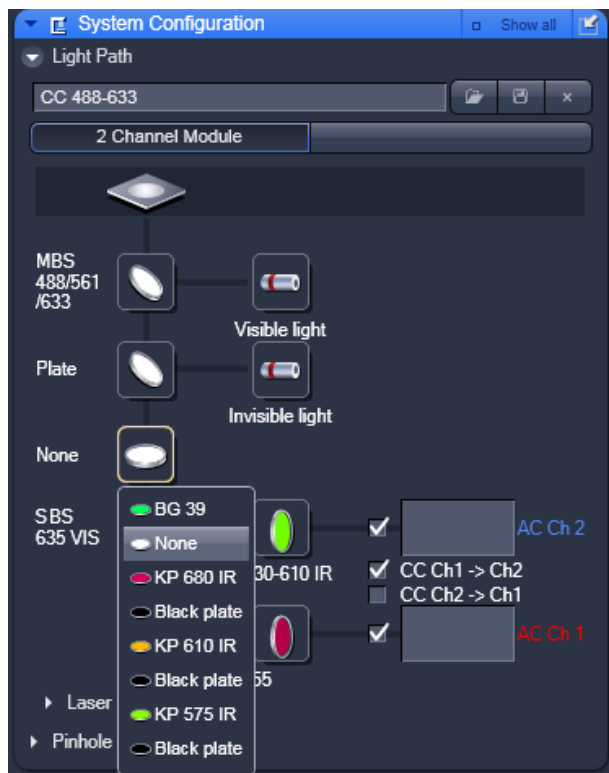


Fig. 25 System Configuration tab - Light Path panel with IBF filter list

Infrared blocking filter (IBF):

The IBF is used to block any IR excitation light in NLO applications. The IBF is positioned in a 90° angle to the incident beam.

- Click on the IBF icon to open a list of block filters (Fig. 25).
- Select the appropriate one by a mouse click.
- Close the list by clicking the icon again.

Secondary dichotic beam splitter (SBS or NFT):

The SBS splits the fluorescence spectrum onto the various detection channels. The longpass (LP) filter lets wavelengths pass above the specified border wavelength and reflects wavelengths below. The shortpass (KP) filter lets wavelengths pass below the specified border wavelength and reflects wavelengths above. The SBS is positioned in a 45° angle to the incident beam.

- Click on the SBS icon to open a list of dichroics (Fig. 26).
- Select the appropriate one by a mouse click.
- Close the list by clicking the icon again.

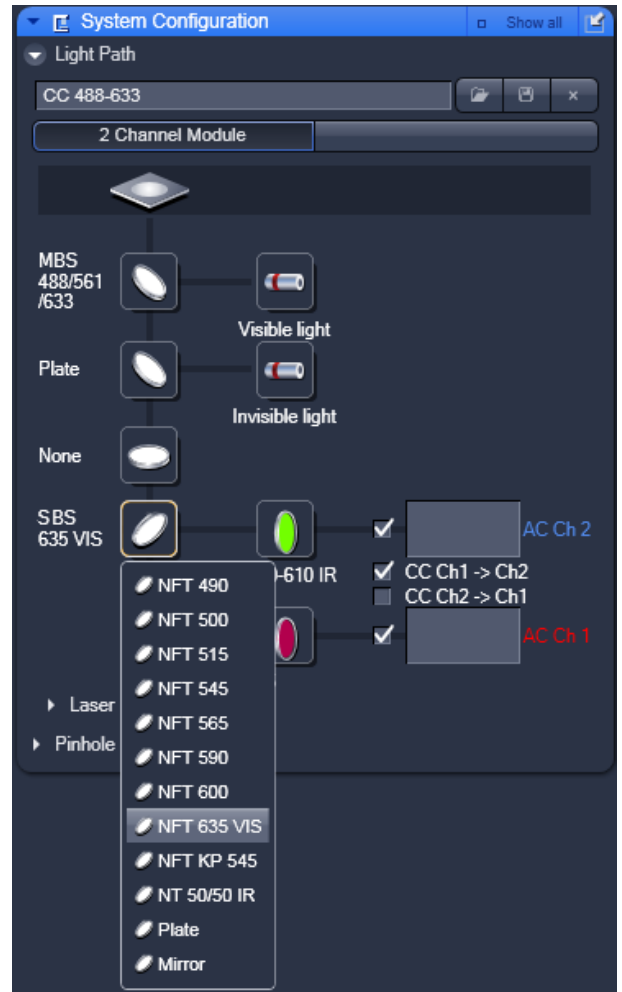


Fig. 26 System Configuration tab - Light Path panel with SBS filter list

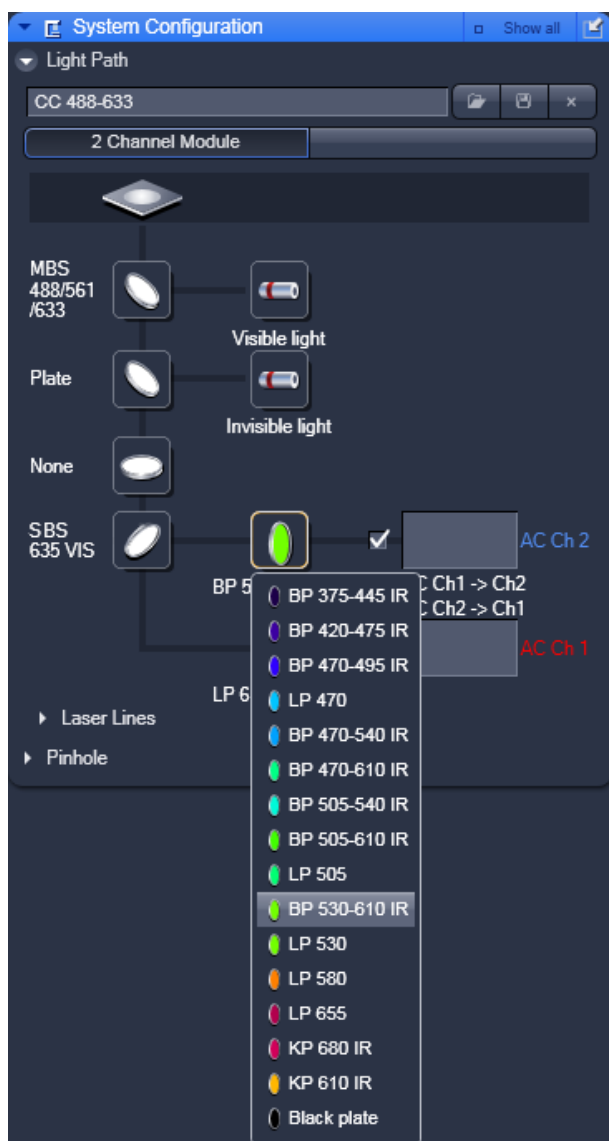


Fig. 27 System Configuration tab - Light Path panel with EF1 filter list

Emission filter 1 and 2 (EF1 and EF2):

The EF is used to narrow the fluorescence spectrum. The bandpass (BP) filter allows the range within the specified border wavelengths to pass through. The longpass (LP) filter allows the range above the specified border wavelength to pass through. The short pass (KP) filter allows the range below the specified border wavelength to pass through. The EFs are positioned in a 90° angle to the incident beam.

- Click on the EF2 or EF1 (Fig. 26) icon to open a list of available emission filters.
All filters can be viewed by using the scroll tab.
- Select the appropriate one by a mouse click.
- Close the list by clicking the icon again.

Selection of channels

You can select channels by activating the **Channel** check boxes:

- AC Ch1 and AC Ch2 are physical channels for auto-correlation
- CC Ch2 → Ch1 and CC Ch1 → Ch2 are software channels for cross-correlation, whereby AC Ch2 is shifted versus AC Ch 1 and vice versa, respectively

You can enter a special comment (for example the used dye or a memorable name) into the **AC Ch1 / AC Ch2** input boxes.

Selection of laser lines

- Press the **Laser** button to display the Laser control expansion submenu (Fig. 28). Alternatively open the **Laser Lines** by clicking on the triangle. They provide settings for:
 - **AOTF Dampening** factor (only visible, if in the **Maintain** area in the **ConfoCor Options** tool the **Control AOTF dampening automatically** check box in register **Measure** in un-ticked),
 - **Measurement / Pinhole Adjustment** laser power,
 - **Bleach** laser power.

Since the expansion submenu will close when clicking in other areas, we recommend to use the **Laser Lines**, if you want to adjust the count rate.

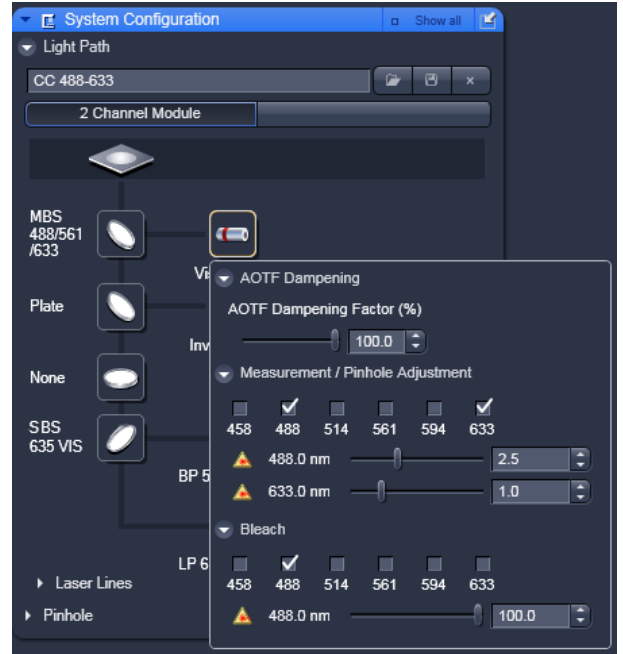


Fig. 28 System Configuration tab - Light Path panel with laser submenu

AOTF Dampening

- Press the **AOTF Dampening** tab to display the AOTF Dampening control panel (Fig. 29). Press again to close the panel
- In the **AOTF Dampening Factor (%)** box the AOTF can be set to suppress the laser light by the defined percentage. You can either type into the display box or use the slide tab or the up / down arrows to define the percentage of which the laser power will be reduced. For example, if the AOTF is set to 2 % and an AOTF dampening percentage is set to 10 %, the actual attenuation is 10 % of 2 %, which is 0.2 %. The Dampening allows to reduce laser powers for bright samples and to extend the range of lower laser settings.

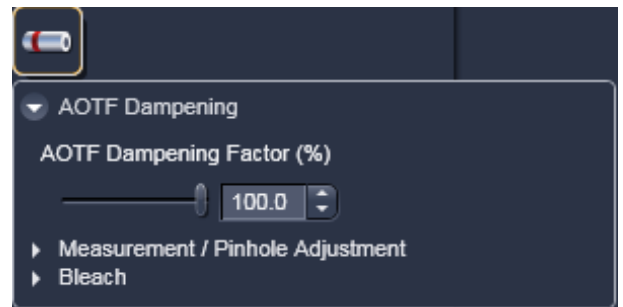


Fig. 29 AOTF Dampening panel

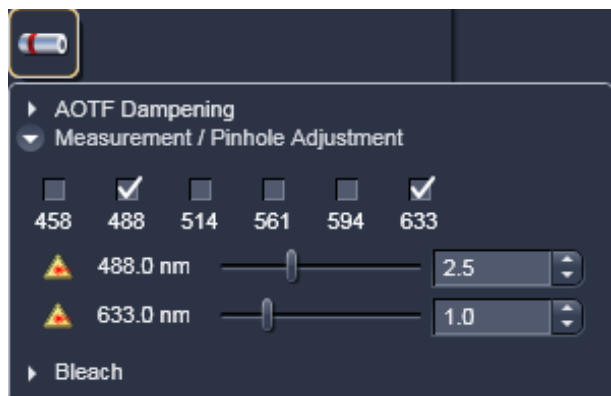


Fig. 30 Measurement / Pinhole Adjustment panel

Measurement / Pinhole Adjustment

- Press the **Measurement / Pinhole Adjustment** tab to display the laser control panel used for measurements and pinhole adjustments (Fig. 30). Press again to close the panel.
- Activate the lasers you want to use by checking the corresponding boxes. The lasers with sliders will appear. Set the requested laser attenuation (%) using the sliders, the arrows, or typing in the display field.

Note, that lasers for measurements and pre-bleach can be selected independently from each other.

If in **AOTF Dampening** a factor different from 100 % was chosen, the set AOTF value in **Measurement / Pinhole Adjustment** will be reduced by that percentage.



Fig. 31 Bleach panel

Bleach

- Press the **Bleach** tab to display the laser control panel used for bleaching (Fig. 31). Press again to close the panel.
- Activate the laser or lasers you want to use by checking the corresponding boxes. The lasers with sliders will appear. Set the requested laser attenuation (%) using the sliders, the arrows, or typing in the display field.

Note, that lasers for measurements and pre-bleach can be selected independently from each other.

If in **AOTF Dampening** a factor different from 100 % was chosen, the set AOTF value in **Bleach** will be reduced by that percentage.

The same options are available for the 405 and 440 lasers, if available, in the **Invisible Light** laser selection box.

All functionalities for laser control are also available in the Laser lines window that will apply for all selected laser lines (Fig. 32).

Procedure for setting the laser power

- Open the **Laser** tool by clicking the **Laser** tab in the **Setup Manager** tool group (Fig. 33). Close the tool box by clicking again. The selections **On** the laser to be switched on, if it is controlled by the software. Switch the requested lasers on, if it is controlled by the software. Switch the requested lasers on by using the pull down menus. The Argon laser has to be switched on and controlled offline. The HeNe lasers and Diode lasers will switch on automatically after Software start. For each laser the properties are displayed of the **Laser Properties** window (Fig. 34) is opened.
- Set the laser attenuation using the sliders in **Measurement / Pinhole Adjustment** from the **Laser** control panel in the **Measurement** Tool of the **ConfoCor** tool box. For this purpose, open the **Countrate** window by clicking the **Countrate** button in the **ConfoCor** tool group. A good starting point is to set the intensity in such a way that a count rate between 50 kHz and 200 kHz is obtained.
- For most dyes, the Counts / Molecule setting should be optimized in a second step to a value just under its maximum by changing the laser power. If carriers of different slide thickness are employed the Counts / Molecule setting should be optimized by using the correction ring on the lens. The correction ring is turned counterclockwise or clockwise until a maximum value is obtained. The correction ring should also be used for adjusting the Counts / Molecule setting whenever the immersion media is changed. This is especially important in cases where the refractive index of the immersion media is different from that of the sample. When finished, close the **Count Rate** window using the **Close** button.

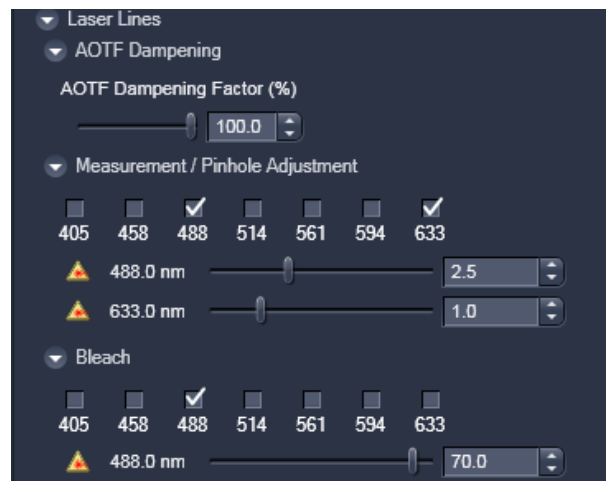


Fig. 32 Laser lines window



Fig. 33 Laser tool window



Fig. 34 Laser Information window

Procedure for defining a new beam path configuration

- First tick the laser or lasers (in case of cross -correlation) you need for excitation of your sample.
 - Then choose a major dichroic beam splitter which should correspond to the chosen laser(s).
 - Select an infrared block filter in case you need one with NLO applications.
- ☞ Please note that you can use IR lasers for FCS, but there are no specifications for the performance of the instrument for this excitation.
- Select the secondary beam splitter.
 - For cross correlation, choose an appropriate filter like the NFT 488/633 beam splitter.
 - For autocorrelation measurements in detection channel 1 you select **Plate**.
 - All autocorrelation measurements in detection channel select **Mirror**.
 - Click the emission filters you need.
 - Activate the channels you want to use. It is recommended to give the channel a name which is easy to remember.
 - Set the laser power.
 - Perform a Pinhole alignment.
 - Store beam path or method, which uses the beam path.

9.6.1.1 Pinhole

The **Pinhole** panel allows you to set the pinhole diameter and to automatically align the pinhole position in x and y.

- Click on the **Pinhole** tab to open the **Pinhole configuration** panel (see Fig. 35). Click on any other register to leave the panel.

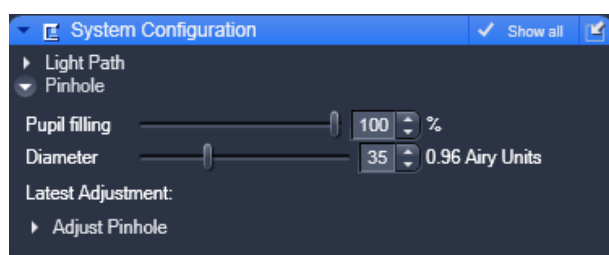


Fig. 35 Pinhole configuration panel

Setting the Pinhole diameter

In the **Pinhole** configuration panel you can set the pinhole diameter of the LSM using the Diameter slider, scroll arrows or the input box (Fig. 35). The display of the input box gives the diameter in μm . The Pinhole diameter in Airy units is automatically calculated and displayed beside the input box.


An optional iris in the excitation beam allows you to enlarge the size of the confocal volume by decreasing the pupil filling. If present a **Pupil filling** slider and input box will be available in the Pinhole menu (Fig. 35). You can enter a value by typing, using the arrows or the slider. The Airy units displayed right of the Diameter slider and input box will be updated automatically.

Note if the system is switched to LSM mode, the

pupil filling will automatically be set to 100 %. The last entered value will be taken when switching back to FCS mode.

- It is recommended to set the pinhole diameter to a size corresponding to the used excitation wavelength that corresponds to 1 AIRY unit:
 - 458 nm 33 μm
 - 488 nm 34 μm
 - 514 nm 39 μm
 - 561 nm 40 μm
 - 633 nm 45 μm

Pinhole sizes are given in μm and AIRY units.

 In the ConfoCor 3 you have one pinhole for both channels from the LSM.

Adjustment of Pinhole positions

The **Adjust Pinhole** panel is used to adjust the beam path to the pinhole of the LSM. Adjustment can be performed manually or automatically. Manual adjustment is not recommended, since the relevant procedure is very complex.

- Open the **Adjust** Pinhole window (Fig. 36). Press the tab again to close the window.

The pinhole is adjusted using a dye solution. The general approach is to move the pinhole cyclically in x and y until the intensity maximum is found. For each excitation wavelength a suitable dye must be used.

We recommend:

- Rhodamine 6 Green (Rh6G) or Alexa 488 for 458, 488 and 514 nm,
- Tetra-Methyl-Rhodamine (TMR) or Alexa 546 for 543 nm and
- Cy 5 or Alexa 633 for 633 nm.

It is also recommended to work with a relatively concentrated solution (10^{-6} mol/l) and low laser power to achieve smooth intensity curves.

- Activate the channel you want to use and that is appropriate for your settings by selecting it in the check bullet. In one channel settings only the active used channel will be available. In two channel settings both channels will be available.

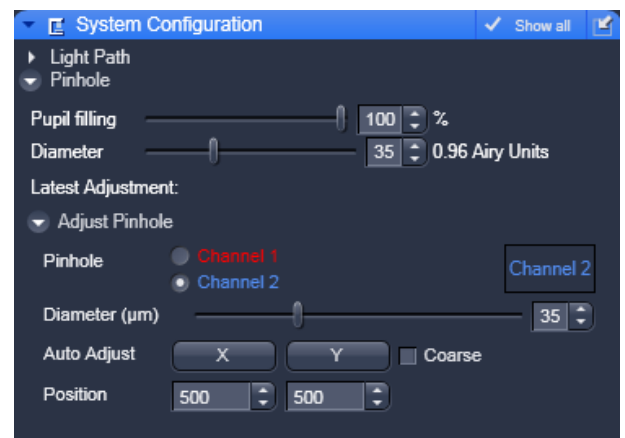






Fig. 36 Pinhole adjustment panel

-  Please note that there is only 1 pinhole for both channels for the ConfoCor 3. You can adjust the pinhole to either channel. The values for the pinhole alignment done with the last channel will be stored and used.
-  A method is always saved together with the beam path configuration, lasers activated, pinhole settings and the measurement conditions. A beam path is saved only with the pinhole settings. Set the desired pinhole diameter using the slider, the scroll arrows or type into the input box.
-  This will alter automatically the pinhole diameter also for the method in the **Pinhole** panel. If you need another pinhole size for doing the pinhole alignment be sure to reset it before saving the method.
- Tick the **Coarse** check box to perform a coarse adjustment in x and y. The pinhole will travel over the maximum range for each axis. Untick to perform a fine adjustment in x and y. The pinhole will travel only a limited distance around the peak found in the coarse alignment.
-  If the pinholes are adjusted for the first time, the coarse adjustment must be performed first and then the fine adjustment, each time for x and y. For subsequent readjustments, the fine adjustment is normally sufficient.
- Click on the **X** and on **Y** auto adjust buttons to perform a coarse / fine alignment of the pinhole in x and y, respectively. In either case, the **Pinhole Adjustment** window will appear (Fig. 37). In the Count Rate/Position diagram, the crosses correspond to the measured intensity (count rate). The line corresponds to the intensity curve fitted to the data points to find the optimum pinhole position. The pinhole will be automatically positioned to the maximum. If a maximum will not be found in the fine alignment, the system will give a warning message. In this case, a coarse alignment must be performed before the fine adjustment.

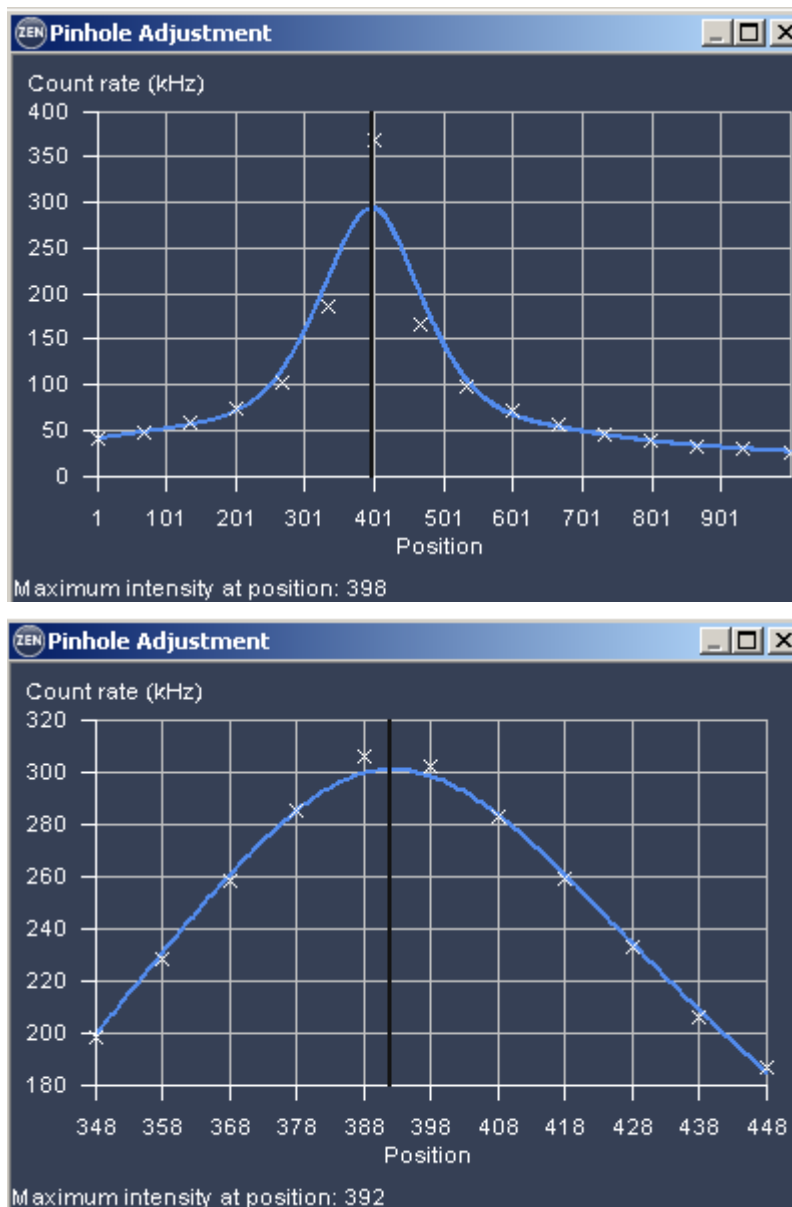




Fig. 37 Automatic Pinhole Adjustment in x coarse (left) and x fine (right)


- You can also alter the position by typing into the input boxes or using the sliders or scroll arrows. If both coordinates are changed, the system will regard this as a new alignment.


 In the ConfoCor 3 the pinhole does not move in z. The Collimator for Invisible light is set to the optimum position in the factory and care should be taken to change its settings. The collimation for the Visible light is done in the laser coupling and does not need optimization.

Procedure to Adjust Pinholes

- Mount a carrier with a suitable dye solution and orient the sample stage. Select the test sample.
- Select the beam path or the method with attached beam path you want to use.
- Set the laser power above 100 kHz, if possible.
- <Open the **Pinhole Adjust** window (Fig. 36).
- Set the pinhole diameter as required
- Select the channel to which you want to adjust in a dual channel set up.
- Adjust both pinhole axes separately in the following order: x coarse, y coarse, x fine, y fine.

 Both pinhole axes x and y must be adjusted. Otherwise the pinhole alignment will not be stored.

 You might be able to increase count rate by adjusting the collimator in the **Collimator** panel for invisible light. To find the optimum collimator settings use either the count rate or images. This function should be changed with care only. The optimal collimator setting is pre-set in the factory. For visible light there is no need for collimation.

 In the Pinhole Alignment, the beam past is adjusted relative to the fixed pinhole. The rationale for pinhole alignment is the following. In a one channel setting, only the selected channel is active and the chosen laser line used. In a two channel setup both channels can be chosen for doing the pinhole alignment. If a secondary long pass filter and two laser lines were selected, than by activating channel 1 the lower wavelength laser will be sued and for channel 2 the longer wavelength laser. If a secondary short pass filter was selected, than this is vice versa. If both laser lines are from the VIS or InVIS/InTune range than only one channel has to be adjusted, since the same beam path is used. However, if one laser is from the VIS range and the other from InVIS or InTune, than you have to adjust both channels. Again, the shorter wavelength laser will be used for channel 2, the longer wavelength laser for channel 1 for a long pass secondary dichroic. If only one laser line is activated with two channels selected, for example when using a 50/50 beam splitter, than this laser line is used for either channel 1 or channel 2. It should be avoided to use an InTune laser line that exactly corresponds to one of the VIS Lines as the system than is non-defined as which laser is used for which channel.

9.7 Acquisition

The Acquisition panel allows you to define the times and positions for your measurement.

- Click on the **Acquisition** register to open the **Acquisition** panel (Fig. 38). Click on any other register to leave the panel.

You have three submenus available:

- **Times**: Used to define measurement times and repetitions.
- **Kinetics**: Used to define delay times between consecutive measurements.
- **Position**: Used to define the measurement positions.

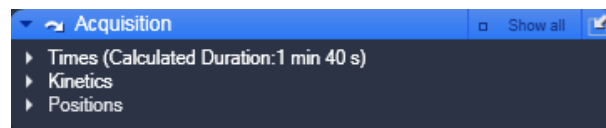


Fig. 38 Acquisition panel

9.7.1.1 Times

In the **Times** panel you can set the values for the **Bleach Time**, **Measure Time** and **Repeat Count** (Fig. 39).

- Click on the **Times** tab to open the **Times** panel (Fig. 39). Click again to close the panel.

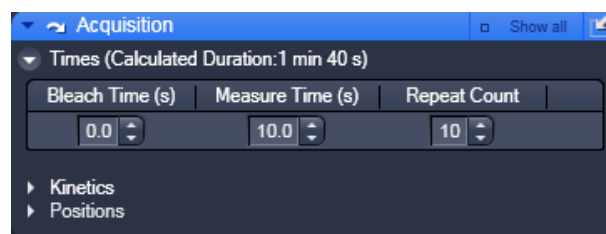


Fig. 39 Times panel

Bleach Time (s)

The **Bleach Time** is the time prior to the measuring procedure during which the laser already has an effect on the sample. It is used to pre-bleach the sample, for example to bleach away immobile molecules that would not contribute to the correlation and would negatively affect the correlation amplitude.

The **Bleach Time** is taken into consideration only **once** (at the beginning of a measuring cycle). Enter a number in seconds in the input box or use the scroll arrows.

- Note that the laser power set under **Bleach** in the **System Configuration Laser panel** will be used for the bleach. If no bleach laser was activated but a bleach time entered, the system gives a warning. Acknowledge if you want to continue anyway.


Measure Time (s)

The **Measure Time** is the period of **one** measurement. As a rule of thumb the measurement time should be about 1000 x the diffusion time of a molecule under study. However, due to noise in the system a 10 s measurement time is a good start value to obtain good statistical results. Enter a number in seconds in the input box or use the scroll arrows.

- Note that the laser power set under **Measurement / Pinhole Adjust** in the **System Configuration Laser panel** will be used for the measurement. If no laser was activated but a measurement time entered, the system gives a warning. Acknowledge if you want to continue anyway.


Repeat Count

The **Repeat Count** value determines the number of measurements, i.e. how often **Measure Time** is to be performed in a row, or in other words the repetitions. Enter a number in the input box or use the scroll arrows.

-  Note that repetitions can be averaged into an average correlation function if required. This will improve statistics. An average of 10 x 10 seconds measurement is not but nearly as good as one 100 sec measurement. If bleaching becomes a problem, it might help to reduce measurement time and increase repetitions to obtain nearly as good statistical results while reducing bleaching.

Procedure for setting the times for an experiment:

- Set the **Bleach Time**.
Start with the **Bleach Time** of 0 s. If the signal decreases during the subsequent measurement, this might be caused by bleaching. As a remedy, you can pre-bleach the sample before measurement by setting the **Bleach Time** to a non-zero value. If no **laser** check box was activated, no bleaching occurs, but the measurement will be delayed for the bleach time.
- Set the **Measure Time**.
If you do not have any idea about the behavior of your sample, start with a measurement time of about 10 seconds. Depending on the signal-to-noise ratio of your correlation curve, decrease or increase the measurement time.
- Set the **Repeat Count**.
Start with **Repeat Count** set to 1. If you want to obtain information about the variation of your fitted values later on, increase the repeat count to produce a measurement series. 10 times is a good value to start with.

-  The total duration of the measurement will be indicated.

9.7.1.2 Kinetics


In the **Kinetics** panel you can set kinetics parameters.

- Click on the **Kinetics** tab to open the **Kinetics** panel (Fig. 40). Click again to close the panel.
- Check the **Use Kinetics** box (Fig. 41) to obtain the **Use Kinetics** panel

You have the following input boxes:


Point to point time (s)

indicate the time spacing between the different kinetic time points in seconds. Enter the number in the input box or use the scroll arrows.

-  Note, if the **Point to Point time** is chosen too short compared to the needed measurement time the system will automatically calculate the minimal needed **Point to Point time**, in the example 10 s. For example, if the measurement was set for 10 x 10 s, but the **Point to point time** to 50 s, than automatically the point to point time will be set to 100 s, which is needed for the measurement itself.

Number

indicate how often kinetic data points will be taken. Enter a number in the input box or use the scroll arrows.

-  Please note that the hierarchy in which measurements are performed in kinetic experiments is channel – repetition – position – kinetics. That means that one kinetic data point corresponds to a measurement at all positions for all repetitions and all channels defined. It is not possible to run a kinetic at one position and than go to the next to run the same kinetics again.

Shape

allows you to choose from three possibilities of distributing the time spacing between single data points: **const** (constant), **linear** and **exp** (exponential). Choose the appropriate entry from the drop down menu.

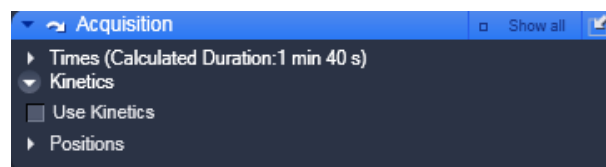


Fig. 40 Kinetics panel

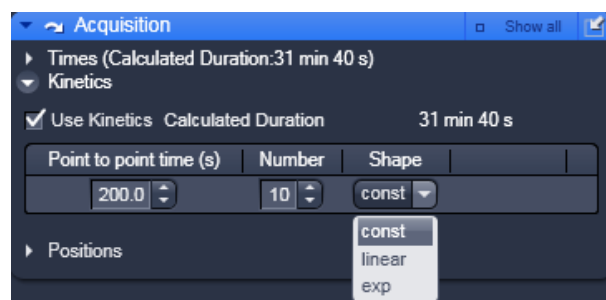


Fig. 41 Use Kinetics panel

Summand / Factor

Summand allows to define the linear increase in the spacing between data points if **linear** was chosen in **Shape**. **Factor** allows to define the exponential increase in the spacing between data points if **exp** was chosen in **Shape**. For **const** this option is disabled. Select a Summand / Factor by choosing an appropriate one from the drop down menu. Note that only predefined values are available.

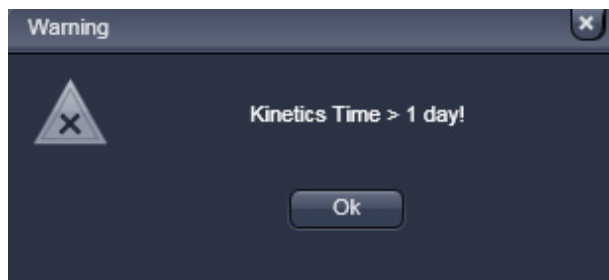


Fig. 42 Kinetic warning

If the kinetic will last for longer than one day, a warning is displayed (Fig. 42). Click **Ok** to continue.

Let's define the following variables:

Time delay between consecutive data points = p_i
(given start value= p_0)

Start time of the measurement: $p_{t,i}$

Number of data points: n

Data point counts = i (note: i starts with 0; so for the first data point $i = 0$; or general $i = n-1$)

Summand/Factor = f

In **const** (constant) the period between two successive data points is constant and will be exactly the time selected in the **Point to Point time** selection box.

With the definition of variables for **const**: $p_i = p_0$; $p_{t,i} = i \times p_0$; $i > 0$

In **lin** the period between two successive data points as specified in the **Point to Point time** selection box is increased linearly by a summand of which the initial value is defined in the **Summand** selection box.

With the definitions of variables: $p_i = p_0 + (i-1) \times f$; $p_{t,i} = i \times p_0 + (i-1) \times f$; $i > 0$

In **exp** the period between two successive measuring cycles as specified in the **Point to Point time** selection box is increased by an exponential factor of which the initial base is defined in the **Factor** selection box. Note, that the first measurement is therefore assigned a 0 for the exponent.


With the definitions of variables: $p_i = p_0 \times f^{i-1}$; $p_{t,i} = p_0 \times (\Sigma f^{i-1})$; $i > 0$

Procedure to set up a kinetics

- Enter the time spacing you want to start with in the **Point to Point time** input box of your kinetics measurement.
- Enter the number of data points in the **Number** box. Remember that the first data point is counted as "0".
- In the **Shape** selection box, set one of the shape options **const**, **lin** or **exp**.
- Enter a number in the **Summand / Factor** selection box.
- Leave the Use Kinetics check box ticked.

The system will display in the **Calculated Duration** box the total time of the experiment taken into account measurement times, kinetic data points and the time the system needs for mechanical switches.


 The start of the single data points can be retrieved from the **Save Info** panel.


 The duration of the kinetic measurement will be displayed in the **Calculated Duration** display box and in the **Time** selection area.

9.7.1.3 Positions

In the **Positions** panel you can select the carrier and the sample or laser position by the stage or by the scanners.

- Click on the **Position** tab to open the **Position** panel (Fig. 43). Click again to close the panel.

 If no carrier was adjusted in the **Carrier Position** tool, no carrier will be displayed. You can omit the adjustment if you work with cells in a single chamber.

 Carriers will be schematically displayed with rows indicated by capital Arabic letters and columns by numbers (Fig. 44).

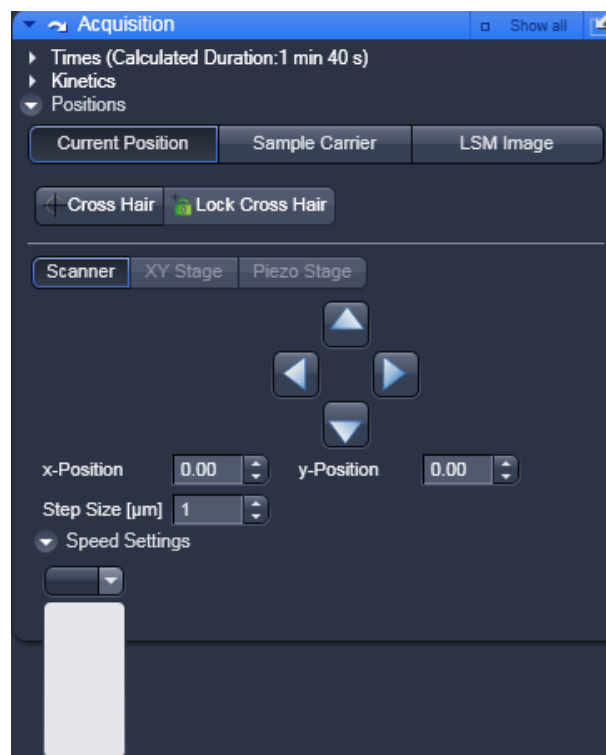







Fig. 43 Current Positions panel

Stage control

- Activate the **XY Stage** control tab to activate stage positioning.
- Move the stage in the appropriate position by clicking on the arrow keys of the **Compass Rose**. Each mouse click moves the microscope stage in the appropriate direction by one step.
- Set the required step width via the **Step-size (µm)** the input box or by using its scroll arrows. The travel speed of the microscope stage can be set to steps **1**, **2** and **3**. Step 2 is preferably used for standard positioning. Step 1 (slow speed) should only be used for very precise positioning, since positioning for longer paths requires more time. Step 3 is suitable if large vessels are used, since precise center positioning only plays a minor role in such cases.
- The current x and y positions are displayed in the **x-Position** and **y-Position** input boxes. You can use the input boxes to change the position by typing in a number or using the scroll arrows. The next click on one of the compass rose arrows will bring the stage or to that position. The next click will move the stage or scanner with the current speed and step sizes in the indicated direction.

-
-  If well positions are changed the system will automatically activate the **XY Stage** tab. The **X,Y Stage** tab will only be available for scanning stages. It is deactivated for manual stages. Even if the **Scanner** button is activated, selecting a well will automatically deactivate the **Scanner** and activates **the X,Y-Stage** mode. If you take an image of the well than the position can be changed in **Scanner** mode within the well.
 -  When the required chamber is approached by joy stick or the compass rose, orientation of the carrier will be lost. Thus positioning has to be done visually via inspection of the carrier in this case.
 -  If the **XY Stage** button is activated, all positioning will be done via the scanning stage.
 -  This mode corresponds to the **Sample Carrier** mode, if **Single Position** is selected. Regardless which well is selected, in the result table of the **FCS results** window the position is indicated as "1".

Scanner control

- Activate the **Scanner** control tab to activate scanning mirror positioning.
 - Move the scanning mirrors in the appropriate position by clicking on the arrow keys of the compass rose. Each mouse click moves the scanners in the appropriate direction by one step.
 - Set the required step width via the **Step-size (µm)** the input box or by using its scroll arrows. The travel speed of the microscope stage can be set to steps **1**, **2** and **3**. Step 2 is preferably used for standard positioning.
 - The current x and y positions are displayed in the **x-Position** and **y-Position** input boxes. You can use the input boxes to change the position by typing in a number or using the scroll arrows. The next click on one of the compass rose arrows will bring the laser beam via the scanning mirrors r to that position. The following click will move the scanning mirrors with the current speed and step sizes in the indicated direction.
-  If the **Scanner** button is activated, all positioning will be done via the scanning mirrors using the compass rose. However, using the joystick or clicking on a well will automatically activate the **XY Stage** tab and movement will be done by the stage.

There are three ways to position the laser beam with respect to the sample by pressing either of the following buttons:

- **Current Position:** no automated positioning possible. Sample has to be manually positioned in respect to the laser beam
- **Sample Carrier:** automated positioning used for maneuvering between wells of a carrier
- **LSM image:** automated positioning using an LSM image


(1) Current Position

In **Current Position** you can select a well from a carrier where you can perform a measurement. You can also control the stage. When using this method, FCS measurements are performed on a fixed position with parked scanners and without automatic table movement. In this case you can measure in solution or by moving the structure of interest to the position manually under LSM control prior to FCS measurements.

- Click on the **Current Position** tab to open the **Current Position** panel (see Fig. 44). Click on any other tab to leave the panel.

Selecting a well

- Orient a carrier in the **Carrier Position** tool. This will display the carrier (see Fig. 45). The current selected well will be highlighted in blue.
- Focus into the sample using the line scanning.
- Select the carrier. The stage will move to the selected well.
- Perform Measurement by pressing the **Start ConfoCor Experiment** action button.

 The laser beam will stay at the optical axis, because positioning of the well is done by the scanning stage. If you want to have the scanner position within the well, you have to go to the LSM image panel, image the solution and position by stage or scanning mirrors.

Cross hair function

When using this method, FCS measurements are performed on a fixed position without scanner or stage. In this case the structure of interest must be moved to the position manually under LSM control prior to FCS measurements. If no offset or rotation was defined the laser position with the parked mirrors is the centre of the image. In other cases the position of the laser beam with this rotation within the image has to be determined by a bleach experiment. The Crosshair is intended as an overlay tool mark the position of the laser beam.



 You cannot select a measurement position with the **Cross hair**; this position will not be approached by the stage or the scanner. Instead you have to move your sample to the position of the fixed laser beam (no stage or scanner movement).




Fig. 44 Current Positions panel

- Bleach a whole in a suitable sample like a dried dye layer and record coordinates.
 - Image your sample.
 - Press the **Cross Hair** button. This will display a cross hair in your scan image. Click again to remove the cross hair. Position the crosshair at the coordinates recorded before. The crosshair will be positioned on the site were you click with the left mouse button. We recommend that having set the crosshair you do not close that **Scan** window. Then the crosshair will be preserved within the new scan. Remember to use the same frame size, resolution and rotation for the image as the one you have used to determine the position of the laser beam. Fix the cross hair by pressing the **Lock Cross Hair** button. This prevents the cross hair from moving by an accidental click in the image window.
 - Scan the image continuously and position the site of interest under the crosshair manually or if a scanning stage is available by using the compass rose with the **XY Stage** tab activated, or a joy stick.
 - Perform your measurement.
-  Please note that the cross hair tool is just an overlay tool and serves only the function to mark a site of interest. It will not position the laser beam at the defined position; the laser will stay with the scanning mirrors parked. It is meant for manually position your sample, if you want to measure without the beam being displaced off the optical axis. If you want to position with stage or scanners, you have to go to the **LSM image** panel.

(2) Sample Carrier

The **Sample Carrier** is used to approach multiple wells sequentially in an automatic mode.

- Click on the **Sample Carrier** tab to open the **Sample Carrier** panel (Fig. 45).


 Note, the scheme of the carrier is only visible, if it was adjusted in the **Carrier Position** panel.

- Select the working direction from the **Working Direction** pull down menu (Fig. 46).


Single Position

Only a single well can be activated. The scanning stage will move automatically to the activated well. This corresponds to **Current Positions** for sample carriers.

- To select the chamber you want to take the measurement in (only one is selectable) click on the one you want to use. The motorized stage moves the selected chamber to the defined position under the objective. If no scanning stage is available, positioning has to be done manually.
- If you want to move to other positions within a well, you can do so by imaging the solution and define positions in **LSM image**.

 In **Sample Carrier** only the **X,Y Stage** tab is active.

- Select one of the three speeds from the **Speed Settings** drop down box.
- Select the step size from the **Step Size (µm)** scroll menu (or the input box) with the scroll arrows or numerically.
- The current position will be indicated in the **x-Position** and **y-Position** selection boxes.

 Note, that before clicking on a chamber you have to orient the carrier. For a non-oriented carrier, all chambers are displayed in grey. Please orient first before you select a position. After orientation, the selected well will appear blue.

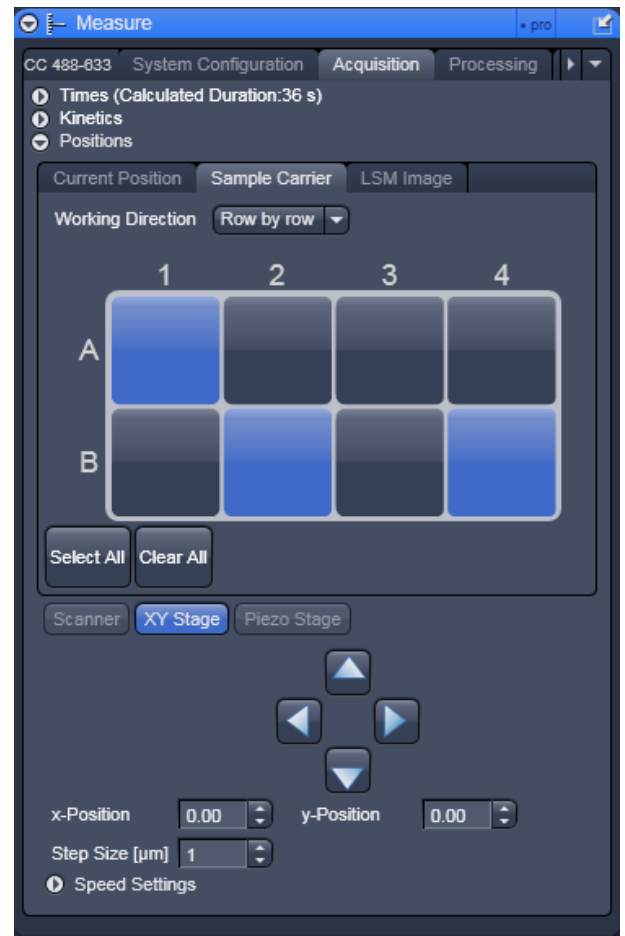


Fig. 45 Sample Carrier panel

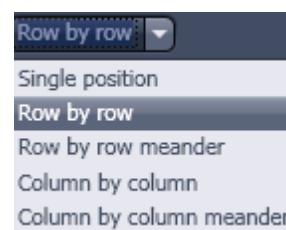





Fig. 46 Working direction drop down menu

-  You can also use the arrow buttons or the joy stick to move the microscope stage, but in those cases, the orientation gets lost. The selected chamber will not any more be highlighted in blue in these case. You can set the size of the steps to be performed via the **Step Size (µm)** scroll menu (or the input box) and the speed in the **Speed Settings** drop down menu.
-  Regardless which well is selected, in the result table of the **FCS results** window the position is indicated as "1".
-  The measurement will be triggered by pressing either the **Snap** or the **Start ConfoCor Experiment** action button.

Multiple positions

- Select from the **Working Direction** drop down menu an entry other than **Single position**.
- Select as many individual well positions as required (all are selectable) by just clicking on them. Alternatively, a whole block of chambers can be selected / deselected by drawing a frame which contains the centers of the selected or deselected chambers.

By pressing the **Select All** button, all wells will be selected.

By pressing the **Clear All** button, all wells will be deselected.


Selected wells will be highlighted and will be approached sequentially as follows:

Row by row: Measurement is performed row by row. Each row starts from the left site.

Row by row meander: Measurement is performed row by row. Rows start alternatively from the left and right. First row starts from the left.

Column by column: Measurement is performed column by column. Each column starts from the top.


Column by column meander: Measurement is performed column by column. Columns start alternatively from the top and bottom. First column starts from the top.

-  If the **Snap** action button is pressed, only the first highlighted position will be approached. To approach all listed positions sequentially the **Start ConfoCor Experiment** action button must be pressed.

(3) LSM Image

The LSM image panel can be used to define several measurement positions in a scanned image, which will be approached sequentially. You can approach this positions either with the scanning stage is the **XY stage** button is activated, or by the mirrors, if the **Scanning** button is activated.

- Click on the **LSM Image** tab to open the **LSM Image** panel (Fig. 47). Click on any other tab to leave the panel.
- Select between **Scanner**, **XY stage** or **Piezo stage**.

 Please note, if you toggle between **Scanner** and **XY Stage**, all marked positions will be lost.

- Press the **Select** button. This activates the cursor (crossline) to allow the definition of positions in the scan image. You can position the crossline via the cursor. Repeatedly pressing the Select button to be active or passive will show or hide added positions.

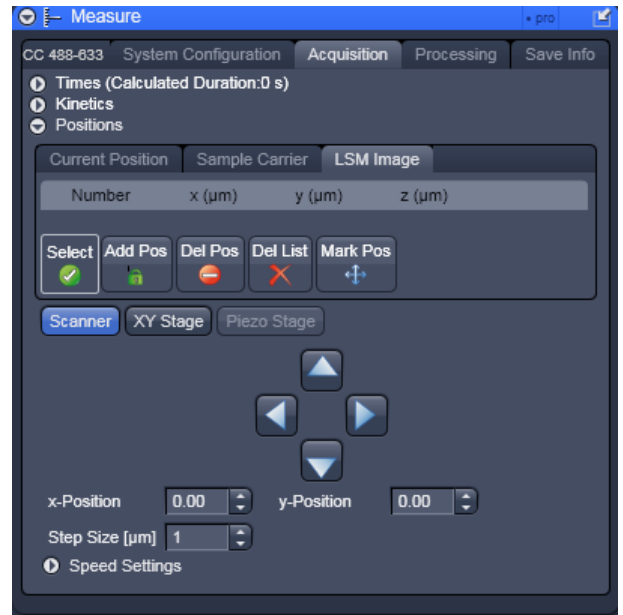


Fig. 47 LSM Image panel

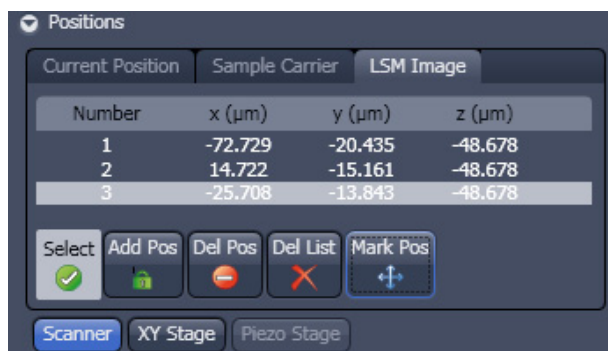


Fig. 48 Position list with 3 positions selected

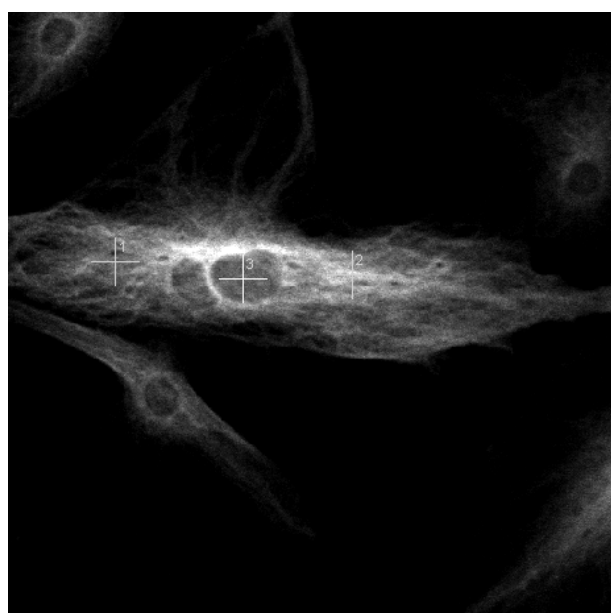


Fig. 49 LSM scan image with 3 selected positions

- Move the cursor to the desired position in the scan image (drag and drop). Press the **Add Pos** button to add the position marked with the crossline to the **Positions** list (Fig. 48). A crossline is set at the selected cursor position in the image (Fig. 49). To select further positions click at the appropriate position in the image and then on **Add Pos**. If more than one position is selected the crosslines are getting current numbers. The Position list displays the numbers and coordinates of the positions in the **Number**, **x (µm)**, **y (µm)** and **z (µm)** display boxes.

In a Z-stack, you can also vary the Z-plane in which measurements are to be performed. For this purpose, select the required Z slice in the stack or set the Z value via the focusing drive of the microscope.

- ☞ Please note, if the **Scanner** button is pressed, the scanner will be positioned to the high-lighted position if the **Count Rate** action button is pressed. If the **X,Y Stage** button is pressed, the stage will not be positioned to the high-lighted position. Only after triggering a measurement the stage will move to the indicated position and will go back to the initial position after the end of the measurement. If you want to obtain the count rate by pressing the **Count Rate** button at the indicated position using the **X,Y Stage** control, you have to start a measurement beforehand.

- ☞ Please note, that positioning is only valid for the active (and stored) scanned image. If you have different images open, be sure to use the one corresponding to your present sample.

- Press the **Del Pos** button to remove selected (highlighted) positions from the **Positions** list and the corresponding crossline in the scan image.
- Press the **Del List** button to remove all positions and all crosslines in the scan image.
- Press the **Mark Pos** button to fix the crosslines as overlay elements in the scan image (Fig. 49). The crosslines will also stay visible in the scan image if the **Select** button is deactivated. If you call up an image later you have to activate the overlay function and a line drawing element to display the crosslines.

- ☞ Please note, positioning is performed by scanning mirrors if the **Scanner** button or by the scanning stage, if the **XY Stage** button is pressed. If more than one position was selected, measurement is only taken at the highlighted position if the **Snap** action button is pressed. To approach all listed positions sequentially the **Start ConfoCor Experiment** action button must be pressed.

- ☞ The X-, Y- and Z- coordinates of the selected positions are only stored in the **Positions** table and not in the scanned image (stack). Accordingly, all the marked positions in all the Z-planes are displayed in the scanned image (Z-stack), no matter in which Z-plane they lie.
- When finished, click on the **Snap** or **Start ConfoCor Experiment** action button to start the FCS measurements at the highlighted or all listed positions, respectively. The measurement procedure starts and the **Image FCS diagram** window appear in a container.
- ☞ Please note that the positions selected for FCS measurements in the **Measurement** window using the ConfoCor 3 are approached by the scanning stage, Piezo stage or scanning mirrors, whichever was chosen. In the ConfoCor 2 scanning mirrors are not available for positioning. All positions will be approached sequentially.
- ☞ In using the scanning mirrors there is no offset between defined positions and actual positions. However, a scan correction in x and y can be required due to scanner hysteresis, which is done by changing the **Scan Corr X** and **Scan Corr Y** positions in the Scan window, if the bidirectional scan was chosen. If stages are used, the offsets can be entered in the **Settings** menu under **LSM + ConfoCor**.

9.8 Processing

In the Process panel you can define the fit and acquisition parameters for the measurement.

- Click on the **Processing** tab to open the processing control panel (Fig. 50). Click on any other tab to leave the panel.



Fig. 50 Processing panel

9.8.1 Fit

The **Fit** panel of the menu allows you to load in a fit model and define how the parameters are to be fitted.

- Click on the **Fit** tab to open the **Fit** control panel (Fig. 51). Click the tab again to close the panel.
- Select a channel by pressing the **Ch1**, **Ch2** or **Cross Correlation** tabs, if applicable. Note that channels will only be active if selected in the current configuration. To each channel a different Fit model can be assigned.

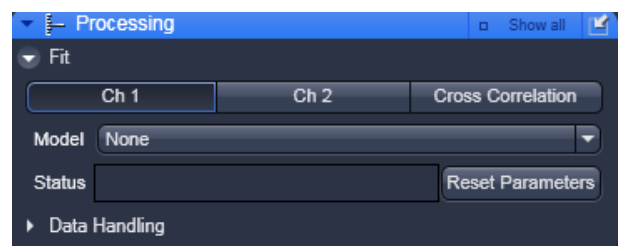


Fig. 51 Fit panel

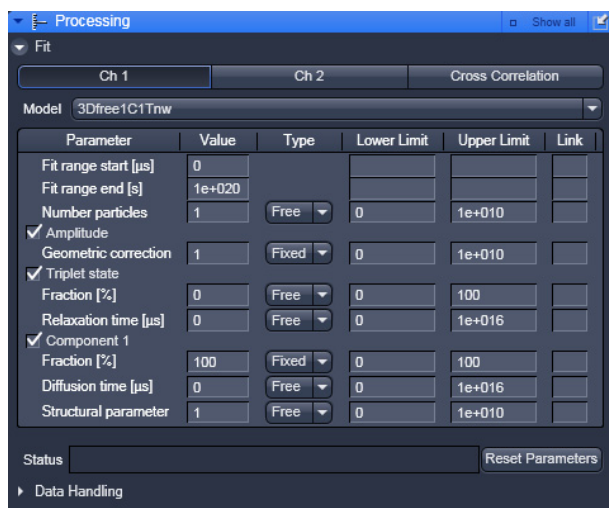



Fig. 52 Fit panel with a model selected for Ch1

- **Value:** designates the currently assigned value of the parameter. You can change the value by typing in the display box.
- **Type:** designates if a parameter is free floating or if its value is fixed or should be used as a start value. You can choose between these options in the drop down menu by selecting **Free**, **Start** and **Fixed**, respectively.
- **Lower Limit:** defines the lower limit value as a fit parameter; if this value is falls short, the fit is rejected and another (global) minimum is searched for. You can change the value by typing the value in the display box. The default value depends on the parameter, but is in most cases 0.
- **Upper Limit:** defines the upper limit value tolerated from a fit; if this value is exceeded, the fit is rejected and another (global) minimum is searched for. The default value depends on the parameter.
- **Link:** globally links the parameter. Type **M**, **K**, **P**, **R** and **C** to link the parameter over measurements, kinetic indices, positions, repetitions and channels, respectively.
- The **Status** display window gives information on conflicts in the entries. For example, if the structural parameter was fixed to 5, but its lower limit set to 6, the system will report this conflict.
- Before saving you can return to the old settings by pressing the **Reset Parameter** button. This will undo all changes. If the method was saved, the new entries will be the default.

 It is generally accepted that non-linear fitting procedures yield more reliable results when the number of free floating parameters is low. It is recommended to fix parameters which are known from independent measurements. Good candidates for fixing are diffusion times of the free dye and the free (i.e. not bound) partner, which can be determined in previous measurements. Another good candidate is the structural parameter that is an instrumental parameter.

 If you press the **Save** button in the **Save Info** panel all changes will be saved.

9.8.2 Data Handling

The **Data Handling** panel allows you to specify the way data will be recorded.

- Click on the Data handling bar to open the Data handling panel (Fig. 53). Click again to close the panel.

All changed settings can be reset to the default settings by pressing the **Default** button.

You have the following options:

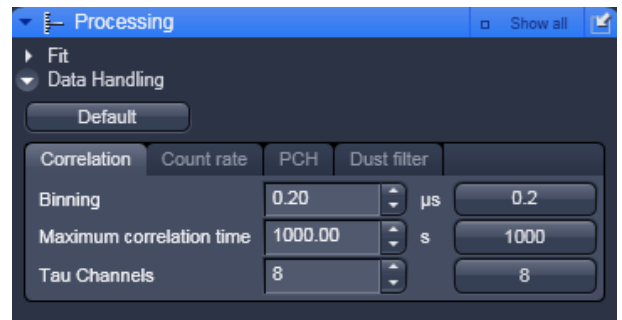



Fig. 53 Data Handling panel

(1) Correlation

The **Correlation** panel allows you to specify, how the raw data will be processed for correlation analysis.

- Click on the **Correlation** register (see Fig. 53) to open the **Correlation** panel. Click any other register to leave the panel.

Here you can set the initial binning time, the initial number of direct Tau channels and the maximum Tau time used for the Multiple Time Algorithm. Adjust the numbers in the **Binning** (in μs), **Maximum correlation time** (in s) and **Tau Channels** display boxes, respectively. You can either directly enter values or use the arrows. Default values can be entered individually by pressing the **0.2**, **1000** and **8** buttons. Please note that with the default settings, the algorithm works the fastest.

 The algorithm for auto-correlation functions is as follows. In the first correlation step all events within a certain correlation interval T are counted. The default T in the first correlation step ($n=0$) equals 200 ns, which is 4x the maximum sampling rate of 50 ns, as limited by the dead time of the APDs and the electronics. T will be changed by the entry in the **Binning** display window. This corresponds to a clock speed of 20 MHz. Thus, for this correlation interval a maximum of 4 events can be counted. These events / correlation intervals are shifted against themselves for a time interval t . The first t equals the first T value, as a default 200 ns = 0.2 ms. t will be changed by the entry in the **Binning** display window. T is linearly increased by step sizes of 200 ns (or the entered value) for 8 times (direct tau) and then for another 8 times (multiple Tau), i.e. the maximum correlation time in the first step is $16 \times 0.2 \text{ ms} = 3.2 \text{ ms}$ using the default settings. The direct and shifted events / correlation intervals are multiplied interval for interval and the products are added together and normalized. The normalization result is defined as: $(\text{result} \times \text{received clocks}) / (\text{pulse}^2)$ for auto-correlation or $(\text{result} \times \text{received clocks}) / (\text{pulseA} \times \text{pulseB})$ for cross-correlation. The received clocks counted equal 4 x the number of correlation intervals, which are defined by the measurement time. At the end the relevant data for the next correlation step are processed. Here, the correlation interval is increased by a factor of 2. Hence, the correlation interval (T) in the n -th correlation step is $T = 0.2 \text{ ms} \times 2^n$ for the default settings. The initial lag time for a certain correlation step corresponds to the last lag time of the previous correlation step added to the respective correlation interval. This value is then linearly increased 8 times. Therefore after step n , the correlation or lag time (t) ultimately corresponds to $t = 16 \times 0.20 + 8 \times 0.2 \times 2^n \text{ ms}$. The doubling of the correlation interval is performed on default 25 times. Thus the maximum is $t = 16 \times 0.2 + 8 \times 0.2 \times 2^{25} \text{ ms}$.

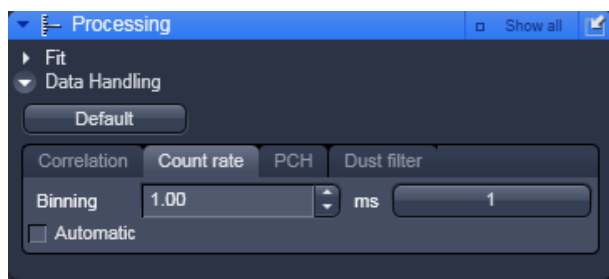



Fig. 54 Count rate panel

(2) Count rate

The **Count rate** panel allows you to specify the binning time used for the count rate trace.

- Click on the **Count rate** register to open the **Count rate** panel (Fig. 54). Click any other register to leave the panel.

You can either check the **Automatic** check-box, in which case dynamic binning will be applied, or you can de-activate the check box and enter a number of a constant binning time (in **ms**) in the **Binning** display window. You can either type in values or use the arrows. Units are displayed at the right of the display box. The default value of 1 ms can be selected by pressing the **1** button.

 In (automatic) dynamic binning the count rate trace will be adjusted to the measurement length. The count rate trace represents the averaged binned count rate versus measurement time, in other words photons / second therefore intensity. The bin window in dynamic binning now depends on the measurement time, whereby the bin window doubles, if 500 values are exceeded. In the first step, the binning time is 3.2 ms. For the next steps, the binning time (t_r) becomes $t_r = 3.2\text{ms} \times 2^n$. The measurement time (t_d), at which the binning time doubles is calculated according to $t_d = 3.2\text{ms} \times 500 \times 2^n$. In automatic binning mode, the **Binning** display window and the **1** default button will not be accessible.

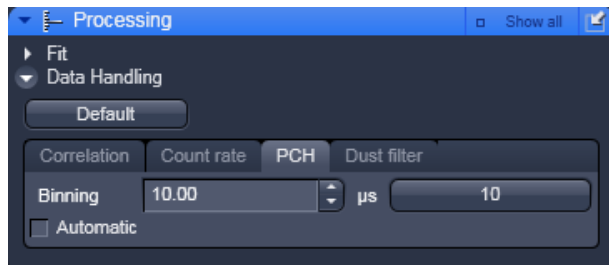



Fig. 55 PCH panel

(3) PCH

In **PCH** panel the binning time used for the photo counting histogram can be selected.


- Click on the **PCH** register to open the **PCH** panel (Fig. 55). Click any other register to leave the panel.

You can either check the **Automatic** check-box, in which case 32 different binning times will be used, or you can de-activate the check box and enter a number of a constant binning time (in μs) in the **Binning** display window. You can either type in values or use the arrows. Units are displayed at the right of the display box. The default value of 10 μs can be selected by pressing the **10** button.

 In automatic binning mode, binning starts with a value of 50 ns, which is doubled 32 times. So binning times are 50×2^n , with $n=1$ to 32. The histogram with the best dynamic range will be selected and displayed. In automatic binning mode, the **Binning** display window and the **10** default button will not be accessible.

(4) Dust filter

The **Dust filter** panel allows you to activate an electronic dust filter that will be active in operation during the measurement. You can define a threshold in the **Count rate** intensity that, if exceeded, will lead to a removal of the corresponding count rate region from the correlation analysis.

- Click on the **Dust filter** register to open the **Dust filter** panel (Fig. 56). Click any other register to leave the panel.
 - Switch the dust filter **On** or **Off** by using the drop down menu.
 - A threshold in % is set by typing in a value into or by using the arrows of the **Deviation to erase peak in Count rate** display window. All measurement points within a binned count rate time window having a deviation of more than the specified value from the average count rate will be cut out and not used for the correlation analysis. The default value of 10 % can be activated by pressing the **10** button.
-  Please note that the cut off count rate is defined as a value exceeding the average count rate during a certain measurement period (bin window) by a certain percentage. Thus, the consecutive fast succession of low peaks might accumulate the same count rate as one high peak within a certain period of time and hence, the cut off is not defined by the peak height but rather by the counts per binning time.

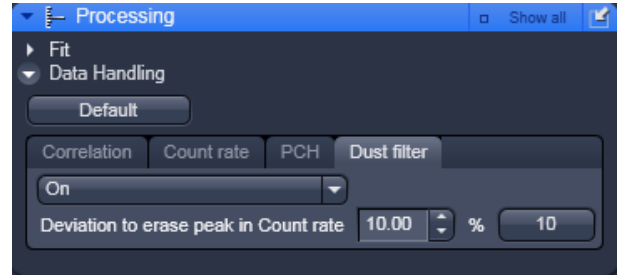


Fig. 56 Dust filter panel



Fig. 57 Models panel

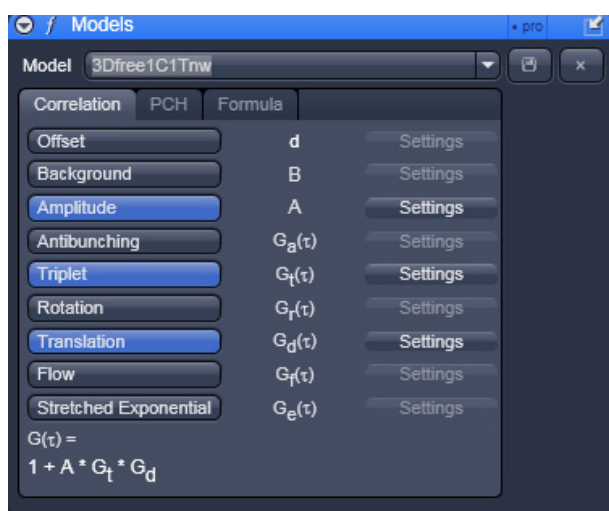


Fig. 58 Models panel – Correlation

9.9 Models

The Models tool is used to define model equations to which measured data can be fitted.

- Click on the **Models** tab to open the Models definition panel (Fig. 57). Click the tab again to close the panel.

You have three options to define a model:

- **Correlation**: assemble a correlation model from predefined equations, which will be fitted analytically
- **PCH**: assemble a photon counting histogram model, which will be fitted numerically
- **Formula**: program a user defined model equation, which can be fitted analytically

9.9.1 Correlation

In correlation you can assemble a model with predefined terms.

- Press the **Correlation** tab to activate the options for assembling a correlation model (Fig. 58). Press any other tab to leave the panel.
- Normally the last defined model will be displayed in the **Equation Select** window. Selected terms will be displayed in blue and the assembled equation will be displayed in the **G(tau)=1** display area. The name of the model will be displayed in the **Model** display box.
- You can load a pre-defined model from the **Model** drop down menu. Its name will then be displayed in the **Model** display box (Fig. 58).
- You can alter the model or leave it unaltered and rename it by typing the new name into the **Model** display box.
- You can save the model by pressing the **Save** button (floppy disc icon). If the name is pre-existing you will be prompted to confirm overwriting the old method. Press **Yes** to acknowledge, **No** to keep the old method.
- You can delete a method from the list by highlighting the method and pressing the **Delete** button (cross icon).

9.9.2 Model Equations

In the following, the mathematical equations of the correlation functions and the fit equations will be more detailed. The acquired correlation functions must be fitted to models in order to retrieve meaningful parameters. It depends on the process, which model is the most appropriate. If the underlying process is known, the model can be chosen a priori. For example, if one studies diffusion in a membrane, a 2-D diffusion model should be applied. In other cases, the process is not known, for example, if one deals with free or anomalous diffusion. In this case, one can screen different potential models and look for the best fit taken into account the X^2 value. Often two models work nearly the same, for example, a two component free diffusion model can give you as satisfactorily a fit as a one component anomalous diffusion model and without prior knowledge on the system it will be impossible to decide, which is the better one. In principle, models can be ruled out, if the fit does not work, however, a working model is only a potential candidate but does not signify it to be the correct one. Care should be taken to minimize the free parameters as much as possible to improve on the fit quality. It does not make too much sense to fit to three components without fixing parameters of at least one of them. If, for example, the diffusion time of a free ligand can be determined in a pre-experiment, that value should be fixed to reduce the number of floating parameters for the evaluation of the binding experiment to its receptor.

The software of the ConfoCor was designed to be flexible. That means that the user can define or assemble equations that do not make sense. Care should therefore be exerted and used formulas matched with the ones from literature to obtain meaningful results. Also, the presence of a model does not automatically mean, that the recorded data are of a quality that allows its usage. For example, anti-bunching requires a lot of care in data acquisition like long measurement times and cross-correlation to reduce dead times of the detectors and elimination of after-pulsing artefacts. It is in the responsibility of the user to set up his experiments accordingly.

(1) The Correlation Function

The auto-correlation function is defined as follows:

$$G^{\delta I}(\tau) = \frac{\langle \delta I(t) \cdot \delta I(t + \tau) \rangle}{\langle \delta I(t) \rangle^2} = \frac{\frac{1}{T} \cdot \int_0^T (\delta I(t) \cdot \delta I(t + \tau)) dt}{\frac{1}{T^2} \cdot \int_0^T (\delta I(t))^2 dt} = \frac{T \cdot \int_0^T (\delta I(t) \cdot \delta I(t + \tau)) dt}{\int_0^T (\delta I(t))^2 dt} \quad (1a)$$

or

$$G^I(\tau) = \frac{\langle I(t) \cdot I(t + \tau) \rangle}{\langle I(t) \rangle^2} = \frac{\frac{1}{T} \cdot \int_0^T (I(t) \cdot I(t + \tau)) dt}{\frac{1}{T^2} \cdot \int_0^T (I(t))^2 dt} = \frac{T \cdot \int_0^T (I(t) \cdot I(t + \tau)) dt}{\int_0^T (I(t))^2 dt} \quad (1b)$$

where $\langle \rangle$ denotes the time average and $\delta I(t) = I(t) - \langle I(t) \rangle$ describes the fluctuations around the mean intensity.

For long time average of I (no bleaching) the following relation exists:

$$G^I(\tau) = 1 + G^{\delta I}(\tau) \quad (1c)$$

Definition of the cross-correlation function

The formalism for the cross-correlation function is identical to the auto-correlation function, with the exception that the signal in one channel is not compared to itself, but to a signal in a second channel. Lets assign the indices "r" and "b" for the red and blue channel, respectively, than the cross-correlation function would read as follows:

$$G_X^{\delta I}(\tau) = \frac{\langle \delta I_b(t) \cdot \delta I_r(t + \tau) \rangle}{\langle I_b(t) \rangle \cdot \langle I_r(t) \rangle} = \frac{\langle \delta I_r(t) \cdot \delta I_b(t + \tau) \rangle}{\langle I_b(t) \rangle \cdot \langle I_r(t) \rangle} \quad (1d)$$

$$G_X^I(\tau) = \frac{\langle I_b(t) \cdot I_r(t + \tau) \rangle}{\langle I_b(t) \rangle \cdot \langle I_r(t) \rangle} = \frac{\langle I_r(t) \cdot I_b(t + \tau) \rangle}{\langle I_b(t) \rangle \cdot \langle I_r(t) \rangle} \quad (1e)$$

☞ Note that the ConfoCor SW calculated G^I functions, which do therefore converge to 1 and not 0. The acquired correlation functions are than compared to model equations.

(2) Available Model Equations

In the following available equations used for the fits are given that define the accessible parameters. For some equations useful conversions to other parameters are listed as well. The total correlation is given by equation 2:

$$G_{tot}^I(\tau) = 1 + d + B + A \cdot \prod_k \sum_l G_{k,l}(\tau) \quad (2)$$

where **d** is the offset, **B** the background correction, **A** the amplitude and $G_{k,l}(\tau)$ the correlation for a single process. The suffixes k and l signify correlation terms for dependent and independent processes, respectively, that are multiplied with or added to each other.

The total correlation is therefore the amplitude multiplied to the product of the single correlation terms that are dependent and hence convolute each other. This amplitude has to be corrected for background and any offset. In cases, when the processes are independent from each other, the single correlations terms add up, for example in cases where there is more than one component all bearing the same label or of bunching terms that are independent from each other. If independent and dependent processes are present, all independent terms will add up and are multiplied with the dependent terms.

One can distinguish between different classes of fluctuation processes: anti-bunching, bunching and diffusion.

A. Amplitudes

The Amplitude of the correlation function is influenced by the offset, background and the number of particles in dependence of the geometric factor. The amplitude is also influenced by the process of correlation.

A.1 The "1"

In a normal correlation, the curve converges to 1, in case intensities I are correlated as is the case with the ConfoCor 3 software. Note that in other cases, if fluctuations δI are correlated, the correlation function converges to 0. If no bleaching occurs

$$G^{\delta I}(\tau) = 1 + G^I(\tau) \quad (2)$$

You can therefore easily convert $G^I(\tau)$ to $G^{\delta I}(t)$ values by adding a fixed offset of -1 .

A.2 Offset d

$$d = c \quad (3)$$

c is any rational number that can be negative or positive.

In the ConfoCor software the offset can be a fit parameter or a fixed value.

In some cases, especially if very slow or immobile components are present, there can be a positive offset from 1. This offset can be taken into account by fitting to d . On the other hand, if the offset is known, it can be fixed. The offset will be added to each correlation value.

A.3 Background B

$$B = \left(1 - \frac{I_b}{I_t}\right)^2 \quad (4)$$

where I_b is the background intensity and I_t is the total intensity.

The background in the ConfoCor Software is always a fixed value and never a fit parameter. This means that the background must be user defined.

Note that the background in this case refers to a non-correlating background. If there is no background intensity, $B = 1$, otherwise $B < 1$. The background can be determined by measuring an unlabeled solution or cell at the same settings than the real experiment and recording the count rate I_b . The real experiment with the labeled species will give I_t . A non-correlating background will result in a lower amplitude and hence overestimation of molecule numbers, if not corrected for. Note the squared correction term.

A.4 Amplitude A

$$A = \frac{\gamma}{N} = G(0) - 1 \quad (5a)$$

where γ is the geometric factor accounting for the point spread function (PSF) and N the mean number of particles.

In the ConfoCor software γ can be a fit or a predefined fixed value. In case γ is a fit value N must be fixed in the fit procedure. N is normally a fit parameter.

Please note that γ takes different values for different fitting models depending on the assumed intensity distribution of the point spread function (PSF):

$\gamma_C = 1.000$ (cylindrical),

$\gamma_{2DG} = 0.500$ (2-D Gaussian),

$\gamma_{3DG} = 0.350$ (3-D Gaussian),

$\gamma_{GL} = 0.076$ (Gaussian-Lorentzian).

γ can also be calibrated, if a known concentration c of a dye is measured. In this case N can be fixed and γ fitted. The obtained number can be entered as the calibrated fixed number. N can be calculated from equation

$$c = \frac{N}{V \cdot L_A} \quad (5c)$$

with V being the confocal volume and $L_A = 6.023 \times 10^{23} \text{ mol}^{-1}$ the Avogadro number.

The volume V is calculated from equation

$$V = \pi^{3/2} \cdot \omega_r^2 \cdot \omega_z \quad (5d)$$

with ω_z axial focus radius and ω_r the lateral focus radius. The radii themselves have to be determined by a calibration measurement using a dye with a high quantum yield and a known diffusion coefficient D from the fitted diffusion time τ_d and the structural parameter S employing a free diffusion model with triplet state.


The following relations exist:

$$\tau_d = \frac{\omega_r^2}{4 \cdot D} \text{ for 1 photon excitation} \quad \text{(5e)}$$

$$\tau_d = \frac{\omega_r^2}{8 \cdot D} \text{ for 2 photon excitation} \quad \text{(5f)}$$

$$S = \frac{\omega_z}{\omega_r} \quad \text{(5g)}$$

Equations 5e or 5f, dependent on the excitation source, can be used to retrieve ω_r ; with its knowledge ω_z can be calculated from equation 5g.

 N can have different meanings in different fit models. For biology, normally the number of diffusing particles is of interest. In this case, if photo-physical processes (triplet, blinking, stretched exponentials) are involved, it is recommended to use their normalized forms, since then the number of molecules correspond directly to the number of diffusing particles. If photo-physical terms are not normalized, the number measured is the total number of diffusing particles and those undergoing photo-physical processes.

B. Anti-bunching Terms

Anti-bunching is the phenomenon that a molecule cannot produce emitted photons as long as it stays in the excited state. Hence during the transition time required to drop back to the ground state, which corresponds in most of the cases to the lifetime if no other photo-physical processes are involved, no photon can be expected, which results in anti-correlation and hence a drop of the correlation function below 1.

B.1 Independent to other terms

$$G_a(\tau) = (1 - C - C \cdot e^{-\tau/\tau_a}) \text{ not normalized} \quad (6a)$$

$$G_a(\tau) = \left(1 - \frac{C \cdot e^{-\tau/\tau_a}}{1 - C}\right) \text{ normalized} \quad (6b)$$

where C is the amplitude and τ_a the transition time, also referred to as the lifetime.

B.2 Dependent in combination with other terms

$$G_a(\tau) = (-C \cdot e^{-\tau/\tau_a}) \quad (6c)$$

C in this case is either a fit parameter or a fixed value and often takes the value 9/5.

There are two cases to be distinguished: First, if the anti-bunching is independent with other processes, than equations 6a and 6b in the non-normalized or normalized form must be used and the terms are multiplied with other correlation terms. In case the anti-bunching is treated dependent to other processes, than equation 6c is the correct one to use and the term is added to other correlation terms.

B.3 Stretched exponential – anti-bunching

This is a more general term adding frequency and stretched factors to the exponent.

$$G_k(t) = 1 - K_1 - K_1 \cdot e^{(-k_1 \cdot t/\tau_{k1})^{\kappa_1}} \text{ not normalized} \quad (6d)$$

$$G_k(t) = 1 - \frac{K_1 \cdot e^{(-k_1 \cdot t/\tau_{k1})^{\kappa_1}}}{1 - K_1} \text{ normalized} \quad (6e)$$

where K_1 is the fraction of molecule, and τ_{k1} the exponential decay time, k_1 the frequency factor and κ_1 the stretch factor.

K_1 and τ_{κ_1} are fit parameters; k_1 is a fixed parameter and must be user defined; κ_1 is either a fit parameter or can be fixed.

Note, fixing k_1 and κ_1 to "1" results in a simple anti-bunching term.

B.4 Double stretched exponential – anti-bunching

This is a double exponential function, where the exponentials are subtracted.

$$G_k(t) = 1 - K_1 - K_1 \cdot e^{(-k_1 \cdot t / \tau_{\kappa_1})^{\kappa_1}} - K_2 - K_2 \cdot e^{(-k_2 \cdot t / \tau_{\kappa_2})^{\kappa_2}} \quad \text{not normalized} \quad (6f)$$

$$G_k(t) = 1 - \frac{K_1 \cdot e^{(-k_1 \cdot t / \tau_{\kappa_1})^{\kappa_1}} + K_2 \cdot e^{(-k_2 \cdot t / \tau_{\kappa_2})^{\kappa_2}}}{1 - K_1 - K_2} \quad \text{normalized} \quad (6g)$$

where K_1 and K_2 are the fractions of molecules, and τ_{κ_1} and τ_{κ_2} the exponential decay times, k_1 and k_2 the frequency factors and κ_1 and κ_2 the stretch factors.

K_1 , K_2 , τ_{κ_1} and τ_{κ_2} are fit parameters; k_1 and k_2 are fixed parameters and must be user defined; κ_1 and κ_2 are fit parameters or can be fixed.

C. Bunching Terms

Bunching is the phenomenon of a burst of photons during a certain time interval, the duration of which is determined by photo-physical processes including triplet, blinking, flickering and protonation. These terms are exponential decay functions. Formally, they look the same, only the exponential decay might be different.

C.1 Triplet

$$G_t(\tau) = (1 - T_t + T_t \cdot e^{-\tau/\tau_t}) \text{ not normalized} \quad (7a)$$

$$G_t(\tau) = \left(1 + \frac{T_t \cdot e^{-\tau/\tau_t}}{1 - T_t}\right) \text{ normalized} \quad (7b)$$

where T_t is the triplet fraction, that is the number of molecules undergoing triplet states and τ_t the triplet decay time.

T_t and τ_t are fitted parameters.

Triplet is based on an un-allowed intersystem crossing from the excited to the so-called triplet state. This state lasts for 1 – 5 μ s. If the electron drops back to the ground state, no photon is emitted and hence during the triplet state the molecule is in a dark state. Triplet is indicated as a rise in the correlation amplitude, which is indicated as a deviation from the flattening curve at shorter correlation times. If not normalized, the triplet fraction contributes to the total number of molecules.

C.2 Blinking

$$G_b(\tau) = (1 - T_b + T_b e^{-\tau/\tau_b}) \text{ not normalized} \quad (7c)$$

$$G_b(\tau) = \left(1 + \frac{T_b \cdot e^{-\tau/\tau_b}}{1 - T_b}\right) \text{ normalized} \quad (7d)$$

where T_b is the blinking fraction, that is the number of molecules in the dimmer state and τ_b the blinking decay time of the dimmer state. Note, if the blinking term is not normalized, the number of blinking molecules will influence the total number of molecules.

T_b and τ_b are fitted parameters.

Blinking is based on the phenomenon that the electron distribution over conjugated systems can change in dependence on the local environment, for example changes in the pH, which will lead to molecules in a bright and dim or dark state. It is therefore a kinetic process that can be described in the following way with the following relations:



$$\tau_b = \frac{1}{k_F + k_R} \quad (7g)$$

$$T_b = \frac{k_F \cdot k_R \cdot (\eta_B - \eta_D)^2}{(k_F + k_R) \cdot (k_F \cdot \eta_B^2 + k_R \cdot \eta_D^2)} \quad \text{with the constraint } \eta_B > \eta_D \quad (7h)$$

with B and D representing the brighter and darker states, k_F and k_R the forward and backward reaction rates and η_B and η_D the emission yields or molecular brightness of molecule species (D or B) in Hz or the relative dimensionless brightness. In case, where darker state is completely dark ($\eta_D=0$), equation 7h simplifies to

$$T_b = \frac{k_R}{k_F + k_R} \quad (7i)$$

Note that Blinking is referred to a process that does not lead to a covalent modification in the chemical bonds. If covalent changes occur the process is referred to as Flickering, which is formally treated in the same way.

C.3 Dependent triplet and blinking

In this case the terms are just representatives for two dependent bunching terms that are linked by addition (double exponential term). Note that the triplet fraction, if present, could be potentially fitted to either of the terms.

$$G_t(\tau) = (1 - T_1 + T_1 \cdot e^{-\tau/\tau_{t1}} - T_2 + T_2 \cdot e^{-\tau/\tau_{t2}}) \quad \text{not normalized} \quad (7j)$$

$$G_t(\tau) = \left(1 + \frac{T_1 \cdot e^{-\tau/\tau_{t1}} + T_2 \cdot e^{-\tau/\tau_{t2}}}{1 - T_1 - T_2}\right) \quad \text{normalized} \quad (7k)$$

where T_1 and T_2 are the fractions of molecules in the triplet state, and τ_{t1} and τ_{t2} the triplet exponential decay times.

T_1 , T_2 , τ_{t1} and τ_{t2} are all fitted parameters.

C.4 Independent triplet and blinking

In this case the terms are just representatives for two dependent bunching terms that are linked by multiplication. Note that the triplet fraction, if present, could be fitted to either of the terms.

$$G_t(\tau) = (1 - T_1 + T_1 \cdot e^{-\tau/\tau_{t1}})(1 - T_2 + T_2 \cdot e^{-\tau/\tau_{t2}}) \text{ not normalized} \quad (7l)$$

$$G_t(\tau) = \left(1 + \frac{T_1 \cdot e^{-\tau/\tau_{t1}}}{1 - T_1}\right) \left(\frac{1 + T_2 \cdot e^{-\tau/\tau_{t2}}}{1 - T_2}\right) \text{ normalized} \quad (7m)$$

where T_1 and T_2 are the fractions of molecules in the triplet state, and τ_{t1} and τ_{t2} the triplet exponential decay times.

T_1 , T_2 , τ_{t1} and τ_{t2} are all fitted parameters.

C.5 Stretched exponential - bunching

In some reactions the kinetics cannot be fitted to simple exponential functions but require stretched exponentials.

$$G_k(t) = 1 - K_1 + K_1 \cdot e^{(-k_1 \cdot t/\tau_{k1})^{\kappa_1}} \text{ not normalized} \quad (7n)$$

$$G_k(t) = 1 + \frac{K_1 \cdot e^{(-k_1 \cdot t/\tau_{k1})^{\kappa_1}}}{1 - K_1} \text{ normalized} \quad (7o)$$

where K_1 is the fraction of molecule, and τ_{k1} the exponential decay time, k_1 the frequency factor and κ_1 the stretch factor.

K_1 and τ_{k1} are fit parameters; k_1 is a fixed parameter and must be user defined; κ_1 is either a fit parameter or can be fixed.

Note, fixing k_1 and κ_1 to "1" results in a simple bunching term.

C.6 Double stretched exponential - bunching

This is a double exponential function, where the exponentials are added.

$$G_k(t) = 1 - K_1 + K_1 \cdot e^{(-k_1 \cdot t / \tau_{k1})^{\kappa_1}} - K_2 + K_2 \cdot e^{(-k_2 \cdot t / \tau_{k2})^{\kappa_2}} \quad \text{not normalized} \quad (7p)$$

$$G_k(t) = 1 + \frac{K_1 \cdot e^{(-k_1 \cdot t / \tau_{k1})^{\kappa_1}} + K_2 \cdot e^{(-k_2 \cdot t / \tau_{k2})^{\kappa_2}}}{1 - K_1 - K_2} \quad \text{normalized} \quad (7q)$$

where K_1 and K_2 are the fractions of molecules, and τ_{k1} and τ_{k2} the exponential decay times, k_1 and k_2 the frequency factors and κ_1 and κ_2 the stretch factors.

K_1 , K_2 , τ_{k1} and τ_{k2} are fit parameters; k_1 and k_2 are fixed parameters and must be user defined; κ_1 and κ_2 are fit parameters or can be fixed.

This term is often required to fit protonation, with the second stretch factor and the frequency factors are set to "1".

D. Diffusion Terms

Diffusion is driven by Brownian motion. We can distinguish translational, rotational and flow diffusion.

D.1 Rotational diffusion

In the most general form, rotation can be described as the sum of 5 exponential terms

$$g_r(\tau) = 1 - R_a + R_a \cdot \sum_{m=1}^5 c_m \cdot e^{-r_m \cdot \tau / \tau_{r,m}} \quad (8a)$$

with R_a being the amplitude, c_m the relative amplitude, r_m the frequency factor and $\tau_{r,m}$ the rotational diffusion time.

However, there are special cases that are of more use.

In symmetric rotation, the general formula reduces to:

$$G_r(\tau) = 1 - R_a + R_a \cdot e^{-\tau / \tau_r} \text{ not normalized} \quad (8b)$$

$$G_r(\tau) = 1 + \frac{R_a \cdot e^{-\tau / \tau_r}}{1 - R_a} \text{ normalized} \quad (8c)$$

with R_a being the rotational amplitude and τ_r the rotational diffusion time.

R_a and τ_r are both fit parameters.

If rotation occurs dependent from other processes, the formula used as an additive term is defined as:

$$G_r(\tau) = R_a \cdot e^{-\tau / \tau_r} \quad (8d)$$

R_a in this case is either a fit parameter or a fixed value and often takes the value 4/5.

In case of asymmetric rotation, the term is as follows:

$$G_r(\tau) = 1 - R_a + R_a \cdot (c_1 \cdot e^{-r_1 \cdot \tau / \tau_{r,1}} + c_2 \cdot e^{-r_2 \cdot \tau / \tau_{r,2}}) \text{ not normalized} \quad (8e)$$

$$G_r(\tau) = 1 + \frac{R_a \cdot (c_1 \cdot e^{-r_1\tau/\tau_{r,1}} + c_2 \cdot e^{-r_2\tau/\tau_{r,2}})}{1 - R_a} \text{ normalized} \tag{8f}$$

with R_a being the amplitude, c_1 and c_2 relative amplitudes, r_1 and r_2 frequency factors and $\tau_{r,1}$ and $\tau_{r,2}$ the rotational diffusion times.

R_a , $\tau_{r,1}$ and $\tau_{r,2}$ are fitted parameters; c_1 and c_2 as well as r_1 and r_2 are fixed values and must be user defined.

Rotational frequencies take often the following values:

r_1	1
r_2	10/3

The relative amplitudes dependent on the polarisation of the excitation light and the analyser in the emission beam path and are as follows:

Ex	lin. pol.	lin. pol.	lin. pol.	unpol.	unpol.	unpol.
Em	parallel	perpendicular	all	parallel	perpendicular	all
c_1	80	20/9	860/9	5/9	215/9	20
c_2	64/9	4	4	16/9	1	1

D.2 Translational diffusion

In its general form, translational diffusion is defined as:

$$G_d(\tau) = \left(\sum_{i=1}^3 \frac{\Phi_i}{\left(1 + \left(\frac{\tau}{\tau_{d,i}}\right)^{\alpha_i}\right)^{e_{d1}} \cdot \left(\left(1 + \left(\frac{\tau}{\tau_{d,i}}\right)^{\alpha_i} \cdot \frac{1}{S^2}\right)^{1/2}\right)^{e_{d2}}}\right) \text{ with the constraint } \sum_i \Phi_i = 1 \quad (8g)$$

with $\tau_{d,i}$ representing the diffusional correlation time of molecule species i , S the structural parameter that is the ratio of axial to lateral focus radii, α_i the anomaly parameter or temporal component of molecule species i , e_{d1} , e_{d2} fixed exponents to define dimensionality of diffusion (1-D: $e_{d1}=1/2$; $e_{d2}=0$; 2-D: $e_{d1}=1$; $e_{d2}=0$; 3-D: $e_{d1}=1$; $e_{d2}=1$)

e_{d1} and e_{d2} are fixed values and have to be user defined. The following values define 1-, 2- and 3-D diffusion:

e_{d1}	e_{d2}	dimensionality
1/2	0	1-D
1	0	2-D
1	1	3-D

Note that in the ConfoCor software these values are automatically selected with the choice of dimensionality.

S is either a fit parameter or a fixed value. It is an instrumental parameter and can be determined by a calibration experiment using a dye solution with a known diffusion as a fit result.

α_i is either a fitted value for anomalous diffusion or a fixed value (set to "1") for free diffusion. The following relation exists

α	Diffusion process
=1	Free diffusion
<1	Anomalous sub-diffusion
>1	Anomalous super-diffusion

Note that α_i is set automatically to "1", if free diffusion is selected. If anomalous diffusion is selected, the parameter will float.

$\tau_{d,i}$ are fitted parameters. They can be converted to diffusion coefficients D_i using formulas 5e or 5f. The ConfoCor software allows you to directly fit to D_i values, but in this case the lateral radius ω_r has to be specified as a fixed value.

Please note that in the case of anomalous diffusion the following relations exist:

$$\tau^{\alpha}_{d,i} = \frac{\omega_r^2}{\Gamma_{2,i}} \quad \text{1 photon excitation} \quad \text{(8h)}$$

$$\tau^{\alpha}_{d,i} = \frac{\omega_r^2}{2 \cdot \Gamma_{2,i}} \quad \text{2 photon excitation} \quad \text{(8i)}$$

with Γ representing the transport coefficient of the fractional time dimension.

Please note the following relation between D and G :

$$D(t) = \Gamma \cdot t^{\alpha-1} \quad \text{(8j)}$$

If activating the fitting to the diffusion coefficient in the ConfoCor the Γ values have to be calculated from the D values by the following conversion:

$$\Gamma = 4 \cdot D \quad \text{(8k)}$$

The Φ_i values are fit parameters. They account for different brightness of different components. In principle, if molecules of different brightness are present, the apparent molecular brightness is defined as

$$\eta = \frac{\sum_{i=1}^3 f_i \cdot \eta_i^2}{\sum_{i=1}^3 f_i \cdot \eta_i} \quad \text{(8l)}$$

with η_i being the brightness of the molecules in kHz or the dimensionless relative brightness values. The brightness of the species has to be determined beforehand in control experiments.

Note that the brightness contributes as the square to the correlation function, in other words a double as bright molecule will contribute 4 fold more. Therefore, the fitted number of molecules must be corrected to obtain the real number N_{diff} of diffusing particles; please note that to obtain the diffusing particle number directly, other terms should be used in their normalized form:

$$N_{diff} = N \cdot \frac{\sum_{i=1}^3 f_i \cdot \eta_i^2}{\sum_{i=1}^3 f_i \cdot \eta_i^2} \quad (8m)$$

If one wants to know the true fraction f_i of each species, values those can be retrieved with the known brightness from the relation

$$\Phi_i = \frac{f_i \cdot \eta_i^2}{\sum_{i=1}^3 f_i \cdot \eta_i^2} \text{ with the constraints } \sum_i \Phi_i = 1 \text{ and } \sum_i f_i = 1 \quad (8n)$$

If there is no brightness difference between the components, Φ_i will become f_i .

In the ConfoCor software you can fit directly to the fractions even in case of different brightness values. In this case, the brightness values have to be fixed parameters and defined by the user. The fit formula converts from equation 5a in combination with 8g taking into account the corrected amplitude to equation 8o:

$$G_{tot}(\tau) = \frac{\gamma}{N} \cdot \frac{\sum_{i=1}^3 f_i \cdot \eta_i^2}{\left(\sum_{i=1}^3 f_i \cdot \eta_i^2 \right)^2} \cdot \left(\frac{\sum_{i=1}^3 \frac{f_i \cdot \eta_i^2}{\sum_{i=1}^3 f_i \cdot \eta_i^2}}{\left(1 + \left(\frac{\tau}{\tau_{d,i}} \right)^{a_i} \right)^{e_{d1}} \cdot \left(1 + \left(\frac{\tau}{\tau_{d,i}} \right)^{a_i} \cdot \frac{1}{S^2} \right)^{1/2} \right)^{e_{d2}}} \right) = \frac{\gamma}{N} \cdot \left(\frac{\sum_{i=1}^3 \frac{f_i \cdot \eta_i^2}{\left(\sum_{i=1}^3 f_i \cdot \eta_i^2 \right)^2}}{\left(1 + \left(\frac{\tau}{\tau_{d,i}} \right)^{a_i} \right)^{e_{d1}} \cdot \left(1 + \left(\frac{\tau}{\tau_{d,i}} \right)^{a_i} \cdot \frac{1}{S^2} \right)^{1/2} \right)^{e_{d2}}} \right) \quad (8o)$$

with fixed brightness values η_i .

D.3 Flow

Flow signifies active transport either via cytoplasmic movement or directed transport.

If flow occurs in the absence of translational diffusion, the term is defined as follows:

$$G_f(\tau) = e^{-\left(\tau/\tau_f\right)^2} \quad (8m)$$

In the presence of translational diffusion, the term alters to:

$$G_f(\tau) = e^{-\frac{(\tau/\tau_f)^2}{1+(\tau/\tau_d)}} \quad (8n)$$

with τ_f representing the average residence time for flow and τ_d the diffusion correlation time.

Note, in the ConfoCor software, the correct term is automatically loaded in dependence on the absence or presence of a translational term.

With the knowledge of the lateral radius ω_r , given as a fixed value, the software allows to fit directly to the velocity v instead of the average residence time. The following relation exists:

$$v = \frac{\omega_r}{\tau_f} \quad (8o).$$

9.9.3 Definition of a Model

- To define a model press the **Term** tab of the term you want to be part of your final correlation equation. The tab will be highlighted in blue. Press the tab again to remove the term from the final equation. The tab becomes grey. You can choose from:
 - **Offset d**: Deviation from 1
 - **Background B**: Unspecific non-correlating background
 - **Amplitude A**: Number of molecules and geometric factor
 - **Antibunching $G_a(\tau)$** : Antibunching correlation term
 - **Triplet $G_t(\tau)$** : Exponential correlation terms for triplet state, blinking, flickering or other bunching correlation terms
 - **Rotation $G_r(\tau)$** : Rotational diffusion correlation terms
 - **Translation $G_d(\tau)$** : Translational diffusion correlation terms
 - **Flow $G_f(\tau)$** : Flow correlation terms
 - **Stretched exponential $G_e(\tau)$** : Stretched exponential correlation terms for kinetics
- All highlighted terms are assembled into the final equation that is displayed in **$G(\tau)=$** display area.
- For a selected term the **Settings** button becomes available. Press the **Settings** button to open the **Settings** panel. Press the **Settings** button again to close it.
- The **Settings** panel allows you to choose specific equations and assign values to parameters, if applicable. The **Settings Description** box provides information on the parameter or displays the formula of the equation. In addition it gives useful conversions of the fitted parameter to other interesting parameters.

The following settings are available:

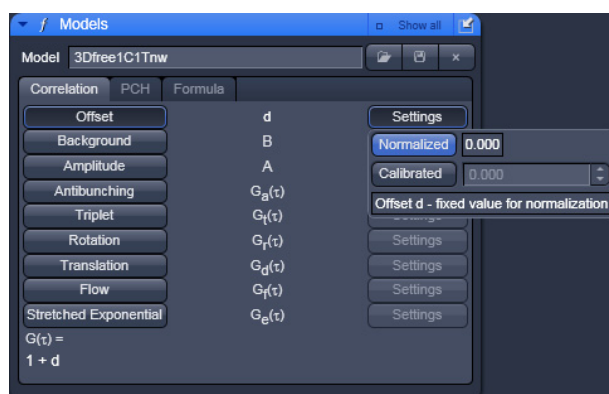



Fig. 59 Offset Settings panel

Offset

- You can set the offset (Fig. 59) to 0 by pressing the **Normalized** button.
- You can define an offset by pressing the **Calibrated** button. This enables you to type in a value in the **Calibrated** selection box, or by setting a value using the arrows.

 Note, the offset can have positive or negative numbers and the value specified will be added to all correlation values.

The **Offset** description box gives you information on the offset.

Background

- You can set an offset by setting a value in the **Background** selection box (Fig. 60). Either type in a value or use the arrows.

The description box gives you information on the background.

 If there is no background selected, the background correction factor will be set to 1.

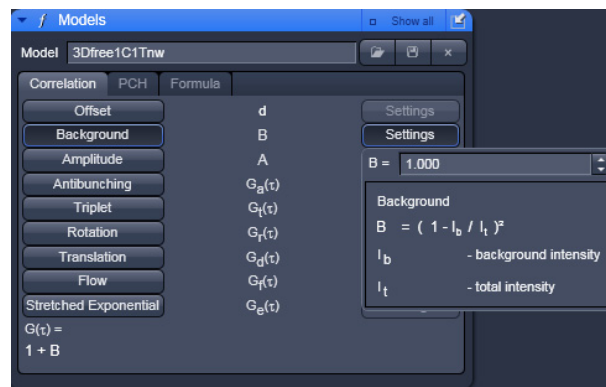



Fig. 60 Background Settings panel

Amplitude

- You can set a value for the geometric factor γ , which describes the point-spread function (Fig. 61).
- By pressing the **cylindrical**, **2DG**, **3DG** and **GL** buttons you can select a cylindrical, 2 dimensional Gaussian, 3 dimensional Gaussian (3DG) and Gaussian-Lorentzian (GL) PSF, respectively. If you press the Calibrate button, you can type in a user defined number in selection box or use the arrows to set a value.

The description box gives you information on the amplitude.

 At least one the γ factor or the number of molecules N have to be fixed in the fit procedure.

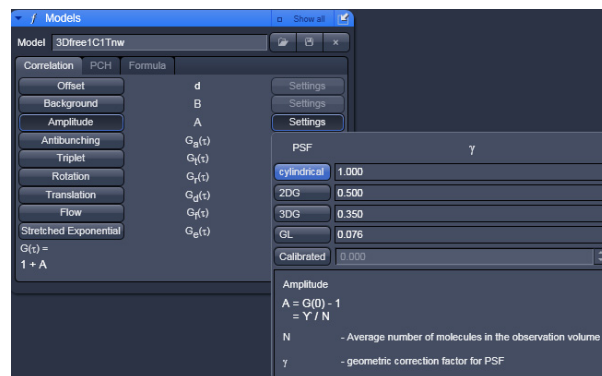


Fig. 61 Amplitude Settings panel

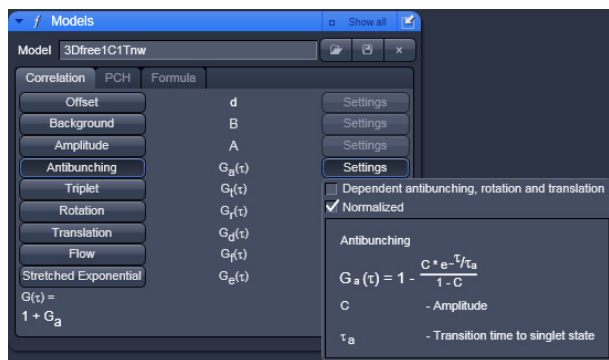


Fig. 62 Antibunching Settings panel

Antibunching

You can select the anti-bunching term in its normalized form by checking the **Normalized** check box or in its non-normalized form by de-checking the box (Fig. 62).

You can select the **Dependent antibunching, rotation and translation** form by checking the respective box. This equation will be used as an additive term to rotational and translational diffusion terms. You have the option to leave the amplitude value free to float or to set the value to 9/5 by pressing the **Free** or **9/5** buttons, respectively. The active selection will be highlighted in blue (Fig. 63).

The description box gives you information on the anti-bunching.

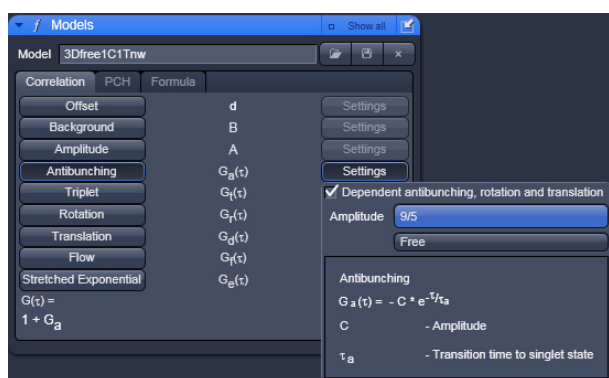


Fig. 63 Antibunching Settings panel - Dependent antibunching, rotation and translation active

Triplet

The triplet represents bunching terms that are exponential decay functions.

You can select the triplet term in their normalized form by checking the **Normalized** check box or in their non-normalized form by de-checking the box (Fig. 64).

You can choose, if you want to the bunching terms to be weighted or not by checking or de-checking the **Weight** box. If no weights are applied, the fit follows the measured curve to minimize X^2 . If no boundary values are set for the relaxation times, noise might also be followed and triplet fractions might show up to be too high. If weights are applied, noise is followed less. The following weight equation is used:

$$Weight(t) = 1 + 10^{-t(t)/3.2 \times 10^{-6}}$$

You have several options for the bunching terms which you can select by the **Components** drop down menu:

Triplet: 1 exponential function

Blinking: 1 exponential function

Independent Triplet and Blinking: Sum of 2 exponential functions

Dependent Triplet and Blinking: Product of 2 exponential functions (see Fig. 65)

The name of the selected term is shown in the **Components** display box.

The description box gives information on the bunching terms.

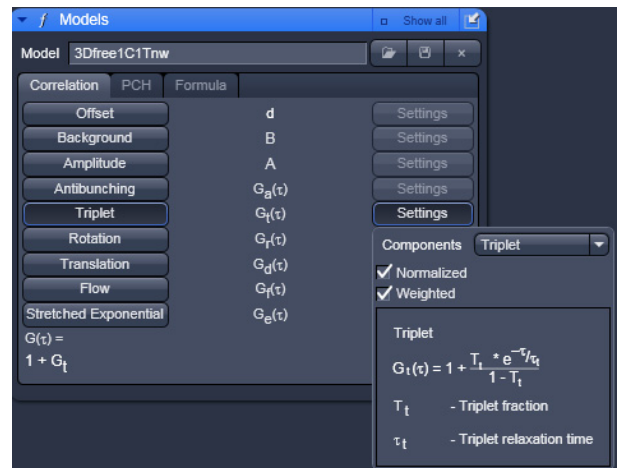


Fig. 64 Triplet Settings panel

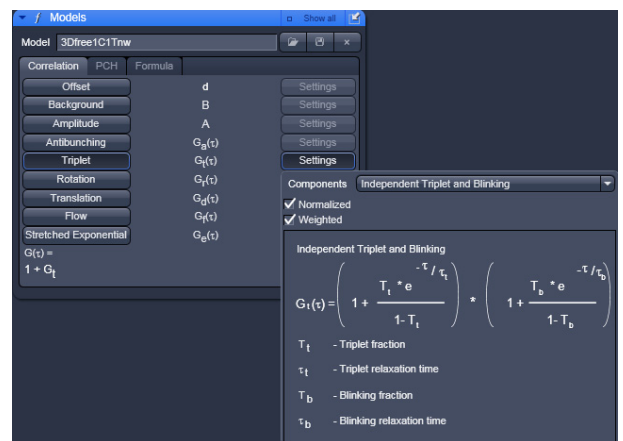
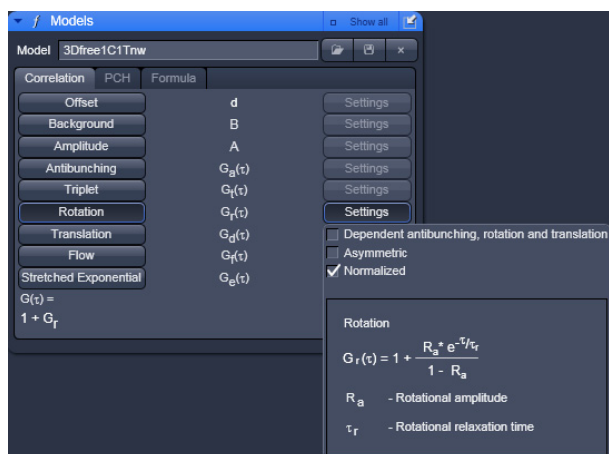


Fig. 65 Triplet Settings panel, independent triplet and blinking terms selected



Rotation

You can select between normalized and non-normalized rotation functions by selecting / deselecting the **Normalized** check box (Fig. 66).

You can select the **Dependent antibunching, rotation and translation** by checking the respective box. This equation will be used as an additive term to anti-bunching and translational diffusion terms. You have the option to leave the amplitude value free floating or setting it to 4/5 by pressing the **Free** or to **4/5** buttons (Fig. 67). The active option will be highlighted in blue.

Fig. 66 Rotation Settings panel

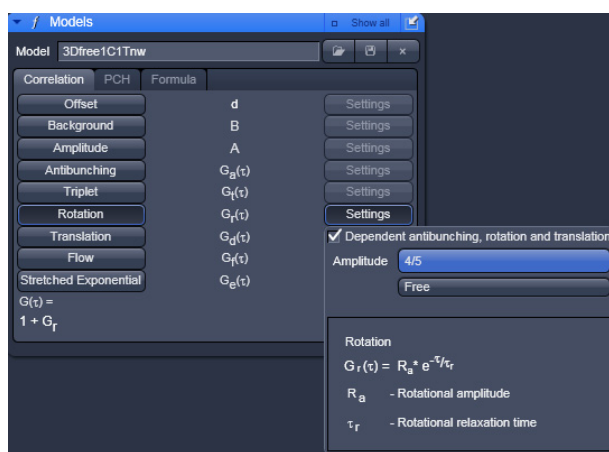


Fig. 67 Rotation Settings panel, dependent... active

You can select between symmetric rotation (1 exponential term) and asymmetric rotation (double exponential term) by selecting / deselecting the **Asymmetric** check box (Fig. 68).

If the **Asymmetric** box is checked, you can define relative amplitudes and rotational frequencies (note, these parameters are no fit values and have to be defined by the user).

Relative amplitudes are defined by selecting the excitation polarization (**linear polarized** or **unpolarized**) and the emission detection (**parallel**, **perpendicular** or **all**), by pressing the corresponding tabs, which will result in the corresponding values displayed in the **c1** and **c2** display boxes. Alternatively, if **others** is activated, you can type in user defined values.

Rotational frequencies can be selected by pressing the **Default** tab to load the default values. The corresponding values will be shown in the **r1** and **r2** display boxes. By pressing the **other** tab, user defined values can be entered.

The description box gives information on the rotational diffusion terms.

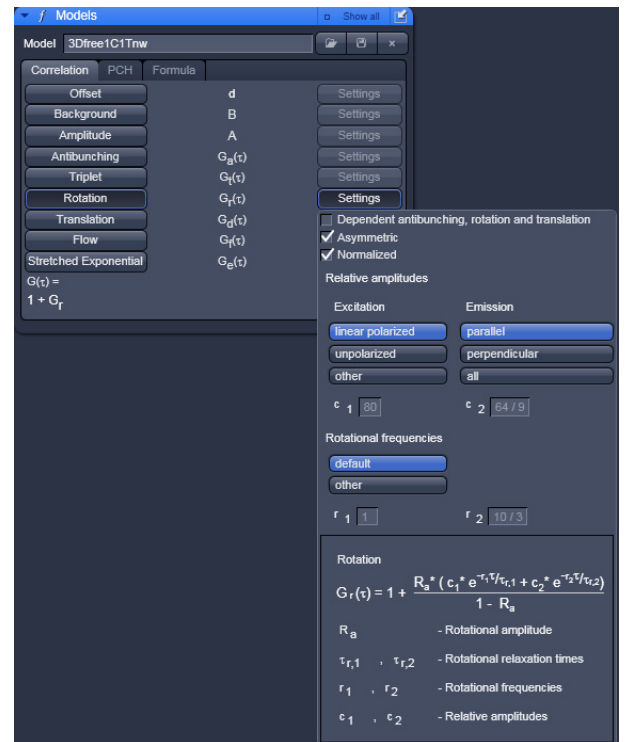


Fig. 68 Rotation Settings panel, Asymmetric rotation checked

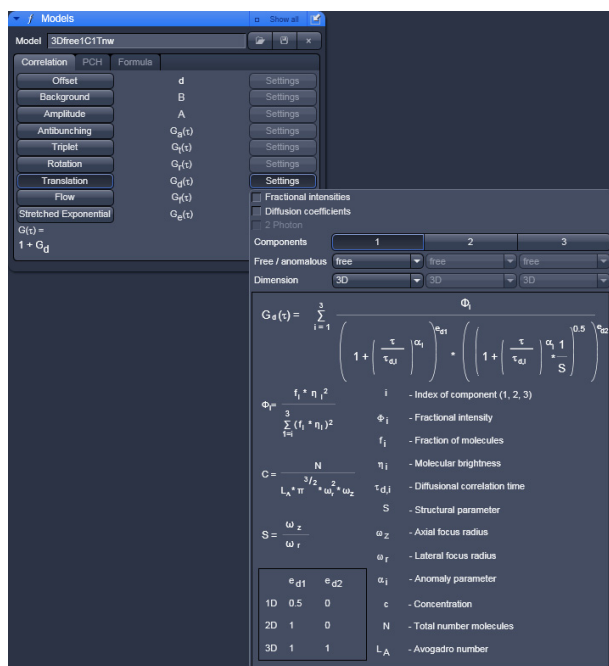


Fig. 69 Translation Settings panel

Translation

You have the following possibilities for setting parameters (Fig. 69):

- You can either fit to fractions (used normally when no brightness differences are observed between different components) or to fractional intensities, by unticking or ticking the **Fractional Intensities** option check box respectively. In the latter case, you have to provide the absolute or relative brightness values of the components, which are entered into the **Molecular brightness** selection boxes.
- You can either fit to the diffusion time, or you can directly fit to the diffusion coefficient by unticking or ticking the **Diffusion coefficients** check box, respectively. In the latter case you have to provide the dimension of the radius of the confocal volume in the ω_r selection box. Either type in a value or use the arrow keys.
- You must also specify if you use two photon excitation by checking the **2 Photon** check box, if since that will influence the fit formula in the case the **Diffusion coefficients** option was chosen.
- You can select the numbers of components (1, 2 and 3) by pressing the **Components 1, 2 or 3** buttons. The number of active components will be highlighted in blue.
- For each component you can select free or anomalous diffusion in the pull down menus of the **Free/anomalous** selection box.
- For each component you can set the dimensionality of diffusion in the pull down menus of the **Dimension** selection boxes. You can toggle between **1-D**, **2-D** and **3-D**.
- For each component you can enter brightness values in the **Brightness** select boxes. These values are only displayed, if the **Fractional Intensities** option is selected. You can type in absolute values (that must have the same units) or relative values.

The description box gives information on the translational diffusion terms.

Flow

You can determine, if you want to fit to the diffusion time or to the velocity directly by un-ticking or ticking the **Velocity** check box (Fig. 70). In the latter case you have to provide the radial dimension of the confocal volume in the ω_r selection box. Type in the number or use the arrow keys.

The description box gives you information on the flow terms. Note, that the system automatically toggles between the pure flow and flow in combination with translational diffusion in cases where the **Translation** term is deactivated or activated, respectively.

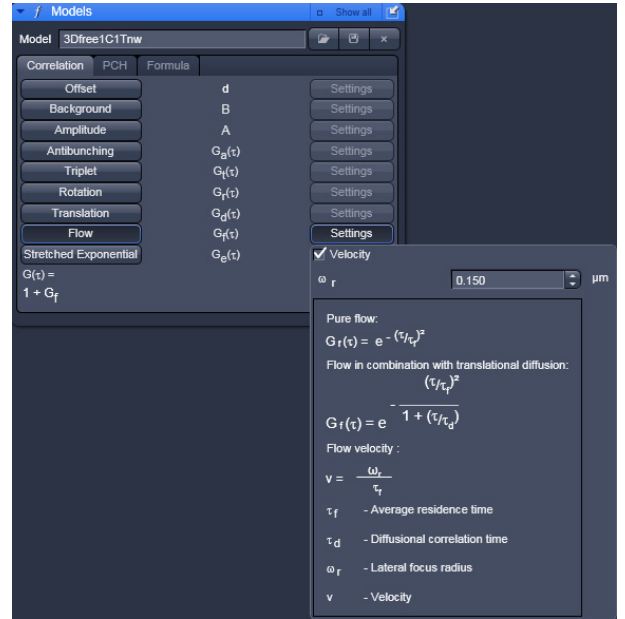


Fig. 70 Flow Settings panel

Stretched exponential

You can select between bunching and anti-bunching terms by pressing the **Bunching** or **Antibunching** buttons, respectively (Fig. 71).

You can select between 1 (mono exponential) or 2 (double exponential) stretched exponential terms by pressing the **Components 1** or **2** buttons. The active option will be displayed in blue

You can select between normalized and non-normalized terms by selecting / deselecting the **Normalized** check box.

You can select between dependent and independent stretched exponentials by choosing from the **Components** drop down menu. This becomes only available, if two components are active.

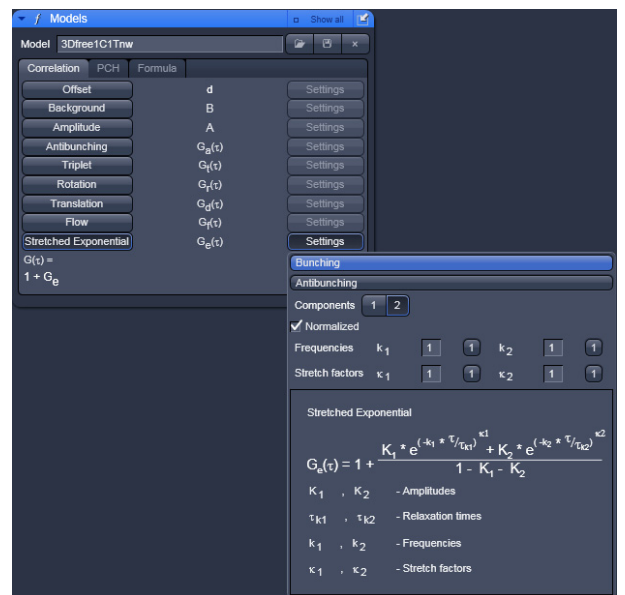



Fig. 71 Stretched exponential Settings panel

 Note, the frequencies and stretch factors are no fit parameters and must be defined in the **Frequencies k_1 and k_2** as well as the **Stretch factors κ_1 and κ_2** display boxes. Either enter a value or press the **1** button for the default setting.

The description box will give information on the stretched exponential terms.

For two components, only the formula for dependent processes is presently available.

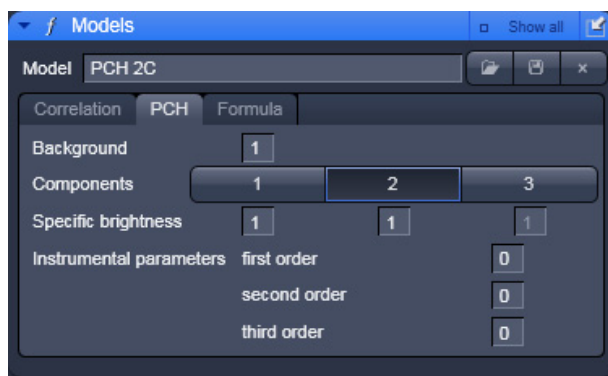


Fig. 72 Model panel, PCH tab

9.9.4 PCH

In the PCH (Photon Counting Histogram) panel you can determine concentrations and the molecular brightness of molecules.

- Click on the **PCH** tab to open the PCH control panel (Fig. 72). Click on any other register to leave the panel.

You have the following options:

- You can enter a background value, if you know the background in the **Background** display box. Enter a zero, if you assume no background. The background is no fit parameter.
- You can choose between 1, 2 or 3 components by activating the **Components 1, 2** and **3** buttons, respectively for each activated component you can enter a brightness value in Hz in the **Specific brightness** enter boxes. If you don't know the brightness, enter 1.
- You can enter **Instrumental parameters** values in the respective **first order, second order** and **third order** enter boxes. These values have to be determined in independent calibration experiments using a defined dye solution with a known brightness. The parameters correct for the deviation of the confocal volume from a true Gaussian distribution. Normally, only a correction for the first order parameter is necessary and recommended. Hence, in the calibration fit you will keep the first order parameter free and the second and third parameters fixed to zero. You can enter the determined first order number and fix it for later measurements.

9.9.5 Formula

The Formula panel allows you to define your own fit equation.

- Press the **Formula** register to open the Formula panel (Fig. 73). Click any other register to leave the panel.

In the **Formula** panel you will have a keyboard in the editor area which you can use to edit your formula. You can also type in directly in the **Formula** display box.

All variables that are defined at the beginning are taken as fixed variables, all others as fit parameters. If variables are defined you have to finish with the return key. Each defined variable must have an assigned number. This number will substitute for the variable in the equation.

A formula has always to be started with G as the dependent variable in the form of $G(x)=$, x any arabic letter. The formula is continuously parsed and any expected operation indicated in the description box at the bottom.

After finishing the formula by clicking into the Display box in a line other than the end of the formula any remaining syntax errors will be displayed. Otherwise parameters and operations are indicated.

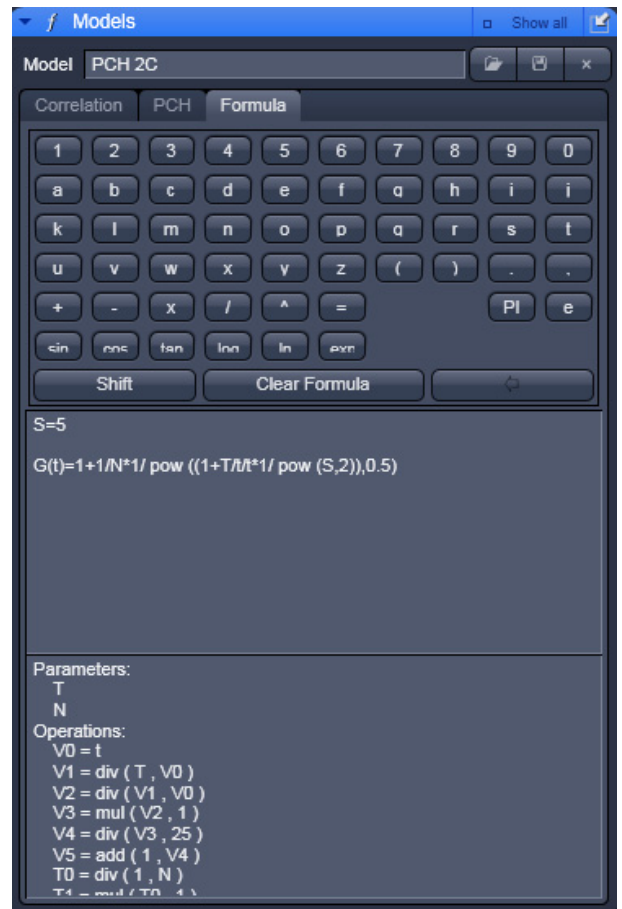


Fig. 73 Model panel, Formula tab

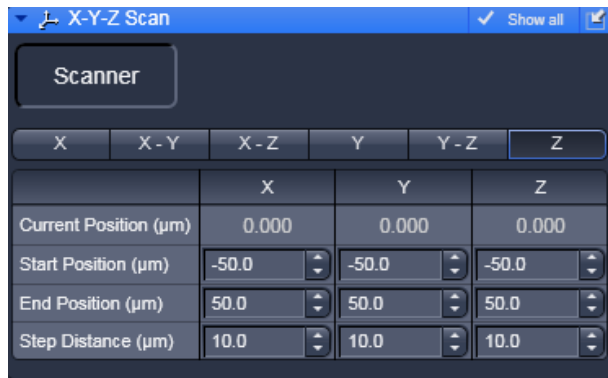


Fig. 74 X-Y-Z Scan tool

9.10 X-Y-Z Scan

The X-Y-Z Scan panel allows you to perform scans in the x, y and z directions and combinations thereof. Especially in the z-direction, it helps positioning the focus to the correct position, e.g. in a cell membrane.

- Click on the X-Y-Z Scan tab to open the X-Y-Z Scan tool (Fig. 74). Click the tab again to close the tool.
- Position your sample in x, y and z.
- Choose the scan you want to perform by pressing either of the **X**, **X-Y**, **X-Z**, **Y**, **Y-Z** and **Z** button. The active scan direction will be highlighted in blue.
- Define the extent of the Scan by using the **Start Position (µm)** and **End position (µm)** input boxes or their scroll arrows. You can see the current position in then **Current Position (µm)** display box. The **X**, **Y** and **Z** directions are indicated above the input boxes.
- Define the step size by using the **Step Distance (µm)** input boxes.
- Perform the scan by pressing the **xyz-Scan** button from the **ConfoCor** tool group panel.

9.11 Save Info

The Save Info panel displays all information about the experiment. It allows you to save all data into a method.

- Click on the **Save Info** tab to open the **Save Info** panel. (Fig. 75). Click again to close the panel.
- The **Method Info** window will display all relevant meta data, including system configuration, measurement protocols and parameter settings. The scroll bar can be used to view the complete information.
- The **Save Infos** window (Fig. 76) will allow you to save the settings. You can save the method by pressing the **Save** button. If the method name exists already, the system will prompt you to confirm overwriting the old method. Press **Yes** to overwrite, **No** to keep the old method settings. If the system settings deviating from default expectations, it will give a warning. For example, if no pinhole alignment was done or if a dual color experiment was set up with one channel or one laser, a corresponding warning will be displayed. Press **Yes** for continuing anyway, **No** for returning to the method without saving.
- You can enter a new method name or replace the old one by typing into the **Name** display window. You can enter a category name or replace an old one by typing into **Category** display box.
- You can give a comment or replace an old one by typing it into the **Comment** display box.
- You can print the content of the **Method Info** window by pressing the **Print** button. This opens the **Print Setup** window and allows the parameters of the method to be printed in the form of a table. You can copy the **Method Info** window into the clipboard by pressing the **Copy** button.

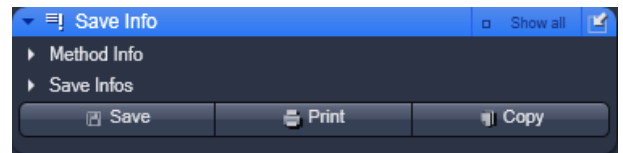


Fig. 75 Save Info panel

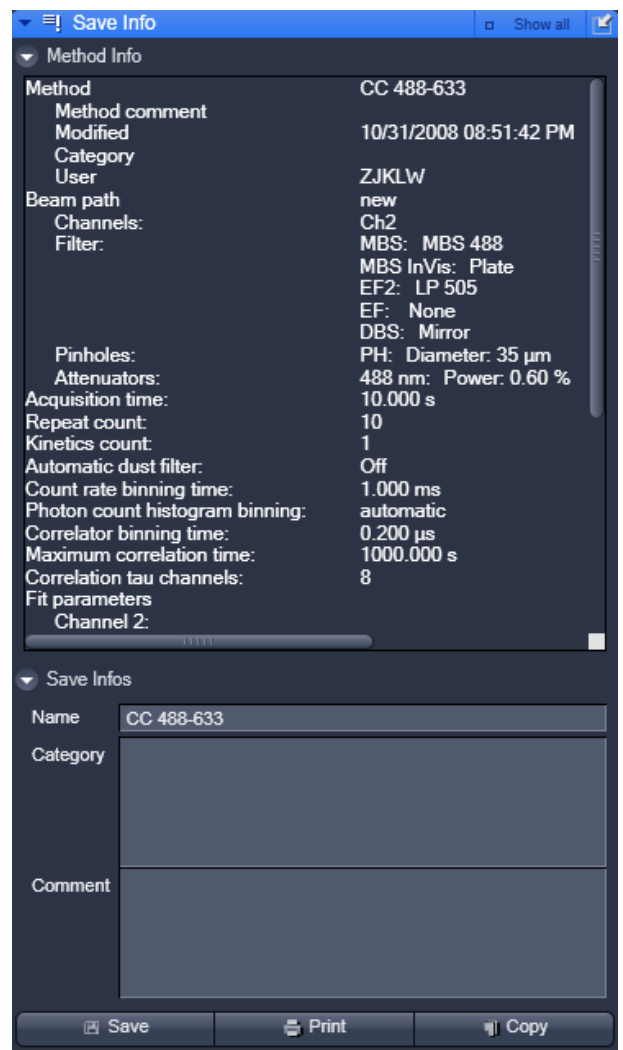


Fig. 76 Save Info panel

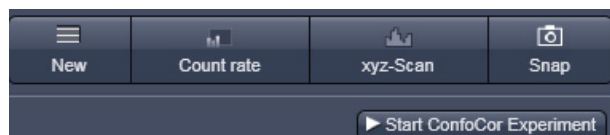



Fig. 77 Action buttons

9.12 Action Buttons

The Action buttons are used to trigger measurements and to adjust the measurement conditions. The following buttons are available (Fig. 77):

- **New:** opens up a new Image FCS Diagram within a container.
- **Count rate:** opens the Count rate window
- **xyz-Scan:** triggers a one dimensional (x, y, z) or two dimensional (xy, xz, yz) Scan
- **Snap:** Starts a single measurement at the first (Sample Carrier) or highlighted (LSM Image) position.
- **Start ConfoCor Experiment:** Starts sequential measurements on all marked or highlighted positions.
- **Stop:** Ends or interrupts the current measurement

 Scans and measurements are performed according to the settings and methods defined in the FCS tools.

9.12.1 Count Rate

- Click on the **Count rate** button to open the **Count rate** window (Fig. 78).

a) Display

Select one of the display modes Count rate, Correlation or Counts/ molecule by pressing the corresponding button. The arrow buttons of the scale tab allow to adjust the measuring range.

- Click on **Count rate Display** button to display the count rate per second (CR) for each activated physical channel (Fig. 78). This value is constantly updated and calculated each 0.5 ms, if **Averaging** is switched **Off**. The expanded display for each channel and Options can be closed by the **Channel 1**, **Channel 2** and **Options** arrows. The blue bar indicates relative levels compared to overload. If system overload occurs, an error message will be displayed and the APDs switched off in order to avoid damage (Fig. 79). Press Ok to continue and laser light intensity or concentration of your sample.



Fig. 78 Count rate window

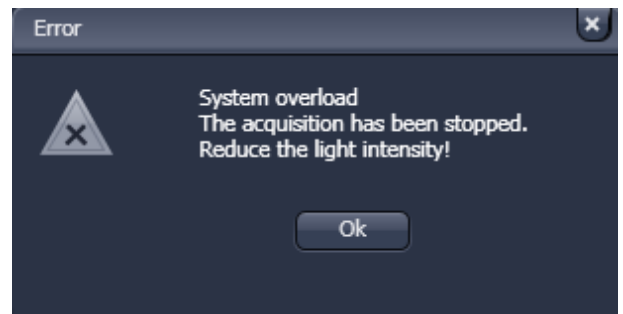


Fig. 79 Overload display



Fig. 80 Count rate window, Correlation and Options Displays activated



Fig. 81 CPM window with Counts per molecule rate and Options Displays activated

- Click on the **Correlation Display** button to display the correlation amplitude ($G(0)$) of each activated physical and Software channel (Fig. 80). This amplitude is constantly updated and calculated each 0.5 ms if **Averaging** is switched **Off**. The expanded display for each channel can be closed by the Channel 1, Channel 2 and Cross Correlation arrows.
- Click on the **Count / molecule Display** button to open the counts per molecule per second (CPM) (Fig. 81). This value is constantly updated and calculated each 0.5 ms if **Averaging** is switched **Off**. The blue bar indicates the extend of the CPM graphically. The expanded display for each channel can be closed by the Channel 1 and Channel 2 arrows.

b) Unit

Select the units of the **Count rate** and **Counts / molecule** displays in **Hz** or **kHz** by toggling between the corresponding button.

c) Average

Averaging for **1 s**, **3 s** or **10 s** or switch averaging **Off** by pressing the corresponding button. Note, if an average is set, the values for CR, $G(0)$ and CPM will be updated only per the average time. In **Off** updates are displayed every 50 ms.

d) Start / Stop

Repeated pressing the **Start / Stop** button will switch the laser shutter on and off. In the **Stop** state, the counter will be set to 0.

☞ You can expand and shrink the Count rate window using the black arrows in the right lower corner.

9.12.2 New

- Click on the New Document button to open a new **FCS Diagram** in an **Image Container**. New diagrams per session will be numbered starting with 0 (Fig. 82).
- Click the **Close** button (cross symbol) in the tab to close the **FCS Diagram**. The **Close Image** window will appear and prompt you to acknowledge closing the diagram if anything on the data was altered. Press **Yes** to save any changes, **No** to discard the alterations and **Cancel** to return to the diagram see Fig. 82.
- A scrollbar at the bottom of the window will allow you to view all data in case the content does not fit the window size.

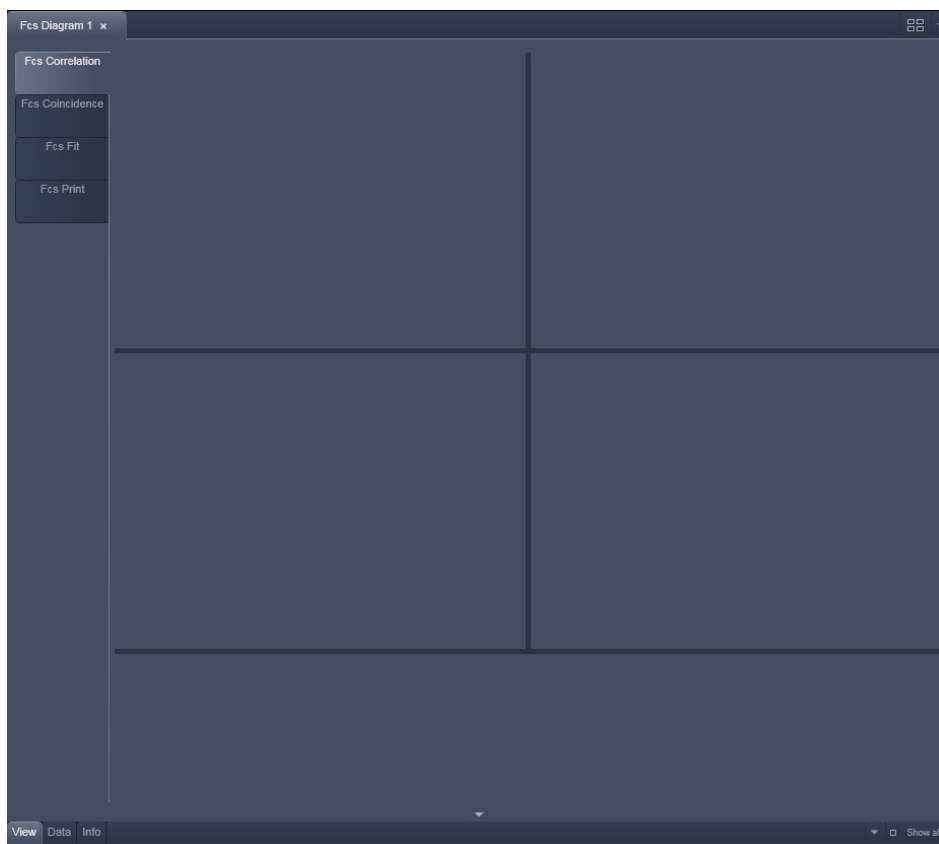


Fig. 82 Image Container with new FCS Diagram opened

The arrow in the container can be used to expand or shrink the display in the vertical direction. The Open Image container on the right displays all currently open Files. Its arrow can be used to expand or shrink the FCS diagram window horizontally.

If one of the **Option** tabs below the diagram are pressed, the corresponding options will be displayed. For the FCS diagram you have the **View**, **Data** and **Info** tabs (Fig. 83) available.

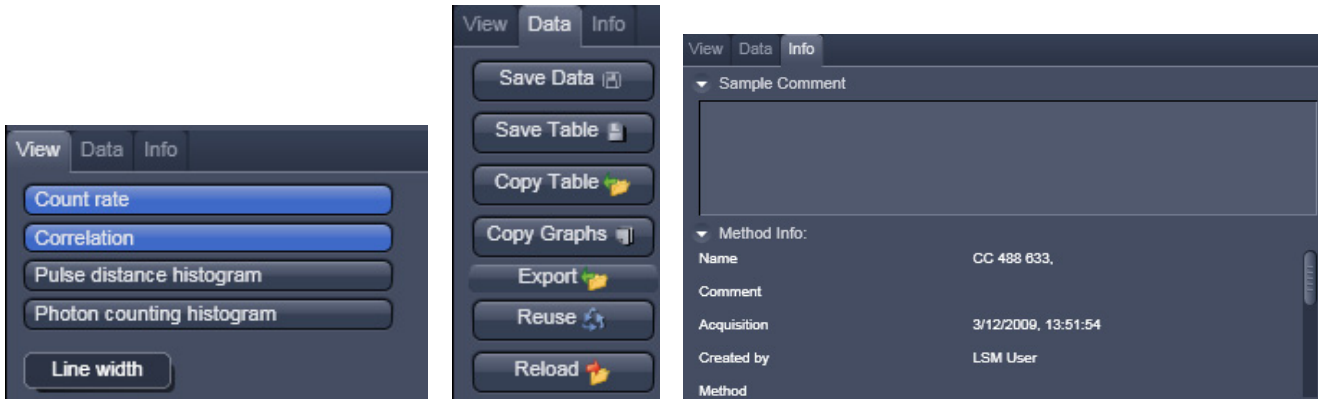


Fig. 83 View, Data and Info tab

The FCS diagram contains four layers, which can be selected by pressing the corresponding tab:

- **FCS Correlation:** Displays the count rate trace, correlation function, photon counting histogram and pulse density histogram. It also displays the result table.
- **FCS Coincidence:** Displays the coincidence diagram of a two channel measurement.
- **FCS Fit:** Displays the fit graph and residuals as well as the used model.
- **FCS Print:** Displays the layout and content of the hardcopy.



 Pressing **New Document** will open an empty FCS Diagram. To generate data in the **FCS Diagram** you have to trigger a measurement by pressing the **Snap** or **Start ConfoCor Experiment** button. After the measurement you can store the data and open it for later use. Stored data will be loaded in an extra FCS diagram in the specified container.



Fig. 84 Close image window

 If you close an **FCS Diagram** without prior saving, you will be asked in the **Close image** dialogue, if you want to save the data (Fig. 84). Press **Yes** to save, **No** to discard or **Cancel** to interrupt the process.

9.12.2.1 Loading Stored Data Files

To load stored data files you have to use the **File** menu from the **Main Toolbar** (Fig. 85).

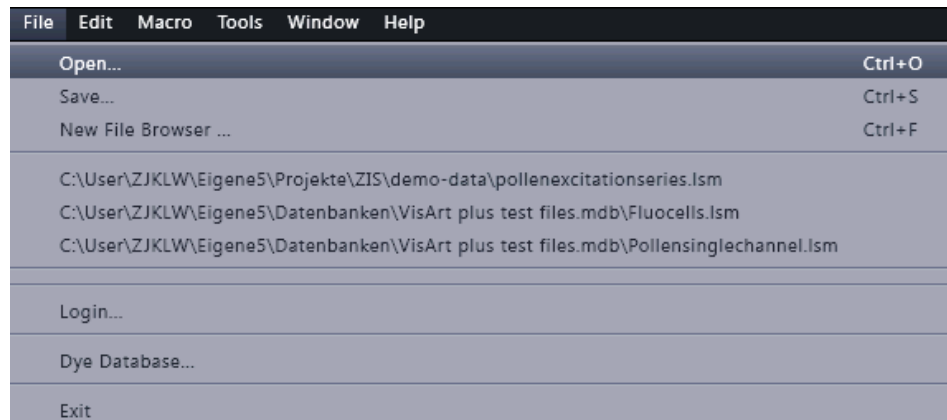


Fig. 85 File Menu

- Go to **File** and then choose **Open**. This will open the Open Dialogue Box for the selection of drives, directories and subdirectories in which data files have been stored (Fig. 86).
- If you want to load a data file from another folder (drive / directory), click on the arrow button to the right of the **Look in** box. This opens a drop-down list box in which you can select from all available folders.
- Select the appropriate data file(s) via mouse click. Choose the extension you need and select the file you want to open. Data formats that will be recognized in the ConfoCor are .fcs (ConfoCor 1: FCS Access Rel. 0.x and 1.x), ConfoCor 2 & 3: LSM Rel. 2.x, 3.x, 4.x, ZEN) and .raw (ConfoCor 2 & 3: LSM Rel. 2.x, 3.x, 4.x, ZEN). If selected together ConfoCor 1 .fcs data files will be opened in one diagram; note that the .fcs data files in this case are single measurements. ConfoCor 2 .fcs data files, if selected together, will be loaded in different diagrams. Note that in this case a .fcs data file can comprise repetitive measurements. The same is true for ConfoCor 3 data files. Raw data files (.raw) will load together in d diagram if selected together. You can also open Images (extension .lsm) that are affiliated with the measurement.

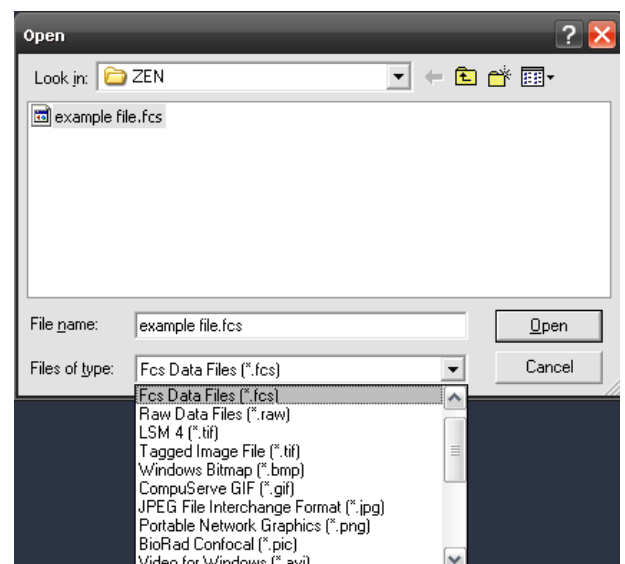





Fig. 86 Open dialog

- This will open the data files or images in new **Image FCS Diagrams** or new **Image**, respectively, in a new Container. Note that the FCS and image will be loaded into different diagrams.

The **Image FCS Diagram** consists of for data layers:

- FCS Correlation
- FCS Coincidence
- FCS Fit
- FCS Print

Each layer will display the data as they were stored last. As default, the first layer **FCS Correlation** will be displayed. Select other layers by pressing the corresponding tabs.

-  If a file format is loaded that is not recognized by the ConfoCor software, an empty **Image FCS Diagram** will open.
-  If a corrupted .fcs or .raw data file is loaded, an empty **Image FCS Diagram** will be loaded.
-  If a .fcs data file is associated with .raw data files, raw data files will be loaded in the **Image FCS Diagram** as well.

9.12.2.2 FCS Correlation

Click on the FCS Correlation tab to activate the FCS Correlation display mode (Fig. 87).

The **FCS Correlation Diagrams** display graphic curves including **Count Rate**, **Correlation Function $G(\tau)$** , **Pulse Density Histogram** (Photon Counting Histogram) and **Pulse Distance Histogram**. It also displays the **Result Table**. A scrollbar at the bottom of the diagram allows to view the content of the displayed window in case it is too small to show all data within the Container size.

Choose the single diagrams you want to display by activating the corresponding buttons in **Diagrams** of the **Options / Correlation Diagrams** field. Selected diagrams will be highlighted in blue. By clicking on the appropriate button, the diagram can be toggled between **ON** and **OFF**.

The **FCS Correlation Diagram** can be horizontally and vertically expanded by closing the **File Handling Area** and by pressing the downward pointing arrowhead beneath the Table scrollbar. The arrowhead will point upwards and pressing it again will restrict the vertical extension of the diagram again. The size of the single diagrams and the table can be matched as required by moving the border lines. Click on the border line, hold down the mouse button, move the line in the required direction; and release the mouse button.

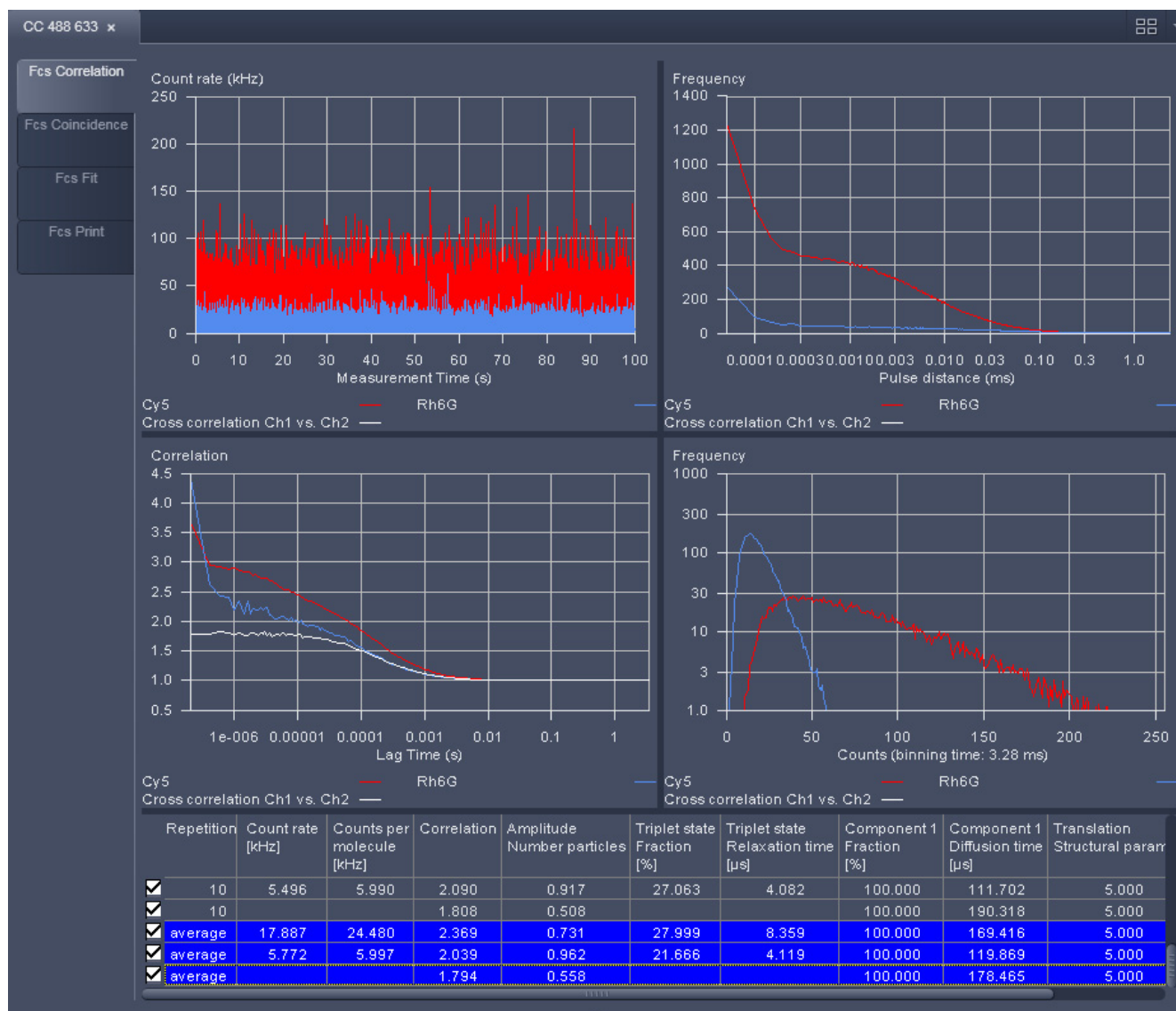
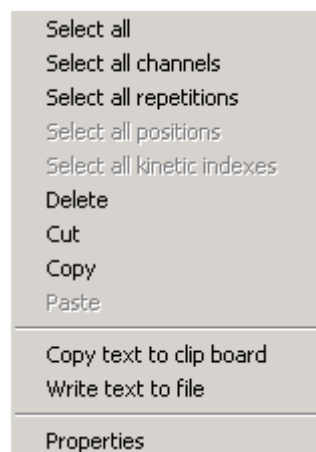


Fig. 87 Image Container with FCS Diagram containing loaded data and FCS Correlation selected

(1) Result Table

The **Result Table** below the diagrams displays the measuring results. The width of the columns can also be changed by moving the border lines. The order of the columns can also be changed. For this purpose, click on the head line of the relevant column, hold down the mouse button and move the column to the required position. When the mouse button is released, the column is inserted in the new position. A scrollbar at the bottom of the table allows one to view all parameters that might not fit within the width of the table.

- To select a line in the table, click on it with the mouse (multiple choice is possible by additionally pressing the **Shift** or **Ctrl** key). Selected lines are highlighted in color and displayed in the legends of the diagrams. The corresponding graphs are shown color coded in the graphic displays.



Selection of lines and properties of the table can be defined by pressing the right mouse button, when the cursor is within the table. This will open the **Result Table** context menu (Fig. 88) offering different options.

Fig. 88 Result Table context menu

Select all	All measurements (rows) in the table will be selected regardless which line was highlighted.
Select all channels	All rows belonging to the same repetitive measurement as the highlighted row will be selected.
Select all repetitions	All rows belonging to the same channel of a repetitive measurement as the highlighted row will be selected.
Select all positions	All rows belonging to the same measurement position than the highlighted row will be selected.
Select all kinetic indices	All rows belonging to the same kinetic time point than the highlighted row will be selected.
Delete	The highlighted rows will be deleted.
Cut	The highlighted rows will be stored in the clipboard. Only if the data are pasted in a new window, the data are deleted from the old one.
Paste	Will paste rows currently stored in the clipboard into the table.
Copy text to clipboard	The contents of the table will be copied into the clipboard and can be opened in other text programs.
Write text to file	Will store the table in a .txt file. You will be prompted to choose a name and a folder.
Properties	Choosing Properties will open the Table Properties window (Fig. 89).

The **Table properties** windows (Fig. 89) chosen from the **Result** context menu, which is opened by a right mouse click within the table, displays several options:

- If the **Show standard deviation** box is checked, all parameters will be displayed with their values and the calculated standard deviation from different measurements.
- In the **Sort order** display window you can choose, how different measurements are grouped together. The hierarchy of grouping of categories is determined by their listed sequence.
- In the **Average** display window you can select, how the data are averaged. You can either select **Fit results**, in which case the single values of the parameters are averaged, or **Correlation results**, where the single data points of each correlation functions are averaged and an average correlation function is calculated.

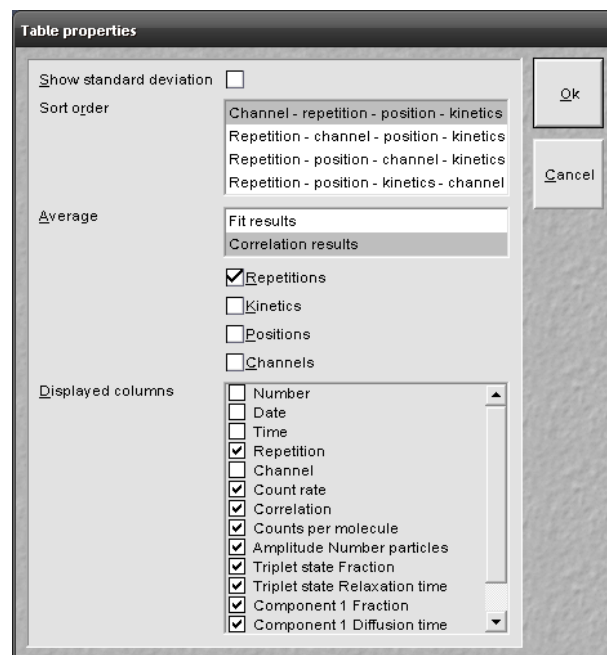


Fig. 89 Table properties window

 Please note, only in the latter case the displayed average correlation function can be meaningfully fitted.

The **Displayed columns** selection window allows you to change the appearance of the table with regard to columns to be displayed. All parameters with their boxes checked will be visible in the table. The order of the displayed columns can be adjusted using drag and drop.

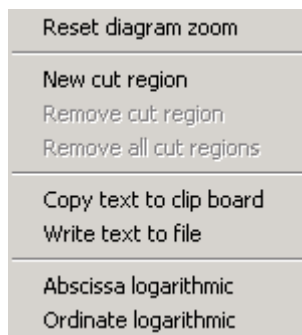
Each row contains a check box on the left-hand side. Deactivation of these check boxes will exclude the relevant rows from all subsequent evaluation procedures like averaging. These settings will be stored by saving the data. Immediate reactivation is possible via the check box, if required.

The **Correlation** tool tab contains the following function elements for different displays:

(2) Count Rate Trace

In the **Count Rate** diagram the count rate(s) (CR) in kHz is plotted vs. running time. If a cross correlation set-up is used, the count rate trace for each channel is displayed. If you have set an electronic dust filter in the **Measurement** tool in **Processing**, loaded Raw data files with an electronic dust filter activated or placed cut limits manually the cut off regions will be displayed as matted areas.

You can zoom in the diagram by pressing the left mouse button and drawing a rectangle of the area you want to zoom in. If the button is disengaged, the zoom image is displayed.




By clicking the right mouse button within the diagram you obtain the **Count rate** context menu (Fig. 90).

- If you have zoomed in, you can go to the original image size by choosing the **Reset diagram zoom** option.
- If you have a raw data file available, you can define cut regions by choosing the **New cut region** option. The cut region size can be adapted by two sliders. The cut out region is thereby displayed as a matted box (Fig. 91). You can select independent cut regions for different channels of a cross correlation experiments. In

Fig. 90 Count Rate context menu

cross-correlation calculations, a cut region in one channel will automatically define the same cut region in the other channel. You can select more cut regions by repeatedly choosing this option.

- These regions can overlap. **Remove cut region** will remove the last cut region. By repeatedly choosing this option, the cut regions in the reverse order of their creation will be removed. **Remove all cut regions** will remove all cut regions simultaneously.

 The remaining parts of the count rate disrupted by cut out regions will be separately correlated and the average will be calculated and displayed.

- **Copy text to clipboard** will copy the diagram coordinates into the clipboard, from which they can be pasted into other programs like Excel. **Write text to file** will store the diagram coordinates in a .txt file. You will be prompted to choose a name and a folder before saving.
- Choosing **Abscissa logarithmic** or **Ordinate logarithmic** will display the abscissa or ordinate in a logarithmic scaling.

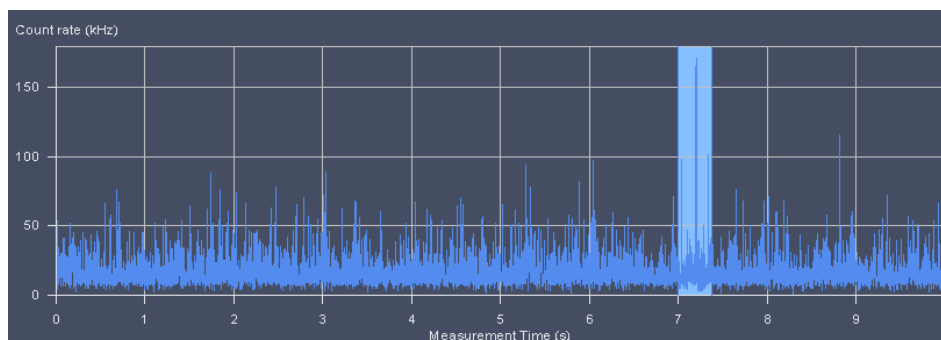


Fig. 91 Count rate trace with cut out regions

(3) Correlation $G(\tau)$

The diagram shows the correlation functions for each activated channel. The zoom function can be used to display certain diagram areas of interest in an enlarged form: Use the left mouse button to click on the margin of the area of interest in the diagram, keep the mouse button pressed and draw a rectangular above the area of interest in any required direction. On release of the mouse button, the selected area is displayed in an enlarged form in the diagram. The scaling of axes is matched automatically.

By clicking the right mouse button you can choose between different options in the **Correlation** context menu (Fig. 92).

- Select the line **Reset Diagram Zoom** with the left mouse button to reset the zoom value.

The data (measuring values) of the diagram can be copied to the clipboard or stored directly as an ASCII file via the context menu.

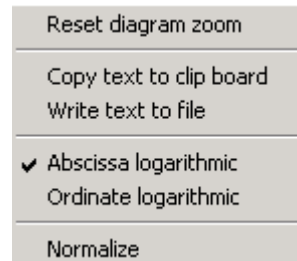



Fig. 92 Correlation context menu


- Select the line **Copy data to clipboard** with a click of the mouse if you want to insert the data directly into other WINDOWS programs via the clipboard. The Paste function permits direct insertion of these data into the required program.
- Select the line **Write text to file** to store the data in an external ASCII file (.txt). Normalized values will also be exported in this way.

 Note that the **Export** button in the **Display Correlation** window will only export the original values.

The diagram display can be manipulated with the context menu as follows:

- Selection of **Abscissa logarithmic** will scale the x-axis logarithmically
- Selection of **Ordinate logarithmic** will scale the y-axis logarithmically.
- Selection of **Normalize** will normalize the curves to 2 (Fig. 93):

 If **Normalize** is selected the $G(0)$ value corresponding to the number of diffusing particles will be normalized to 2, not the total correlation to which also other processes like triplet state can contribute. All other values (subtracted by 1) will then be multiplied by the correction factor defined by the ratio of 1 to $[G(0)-1]$ and increased by 1, hence $G(\tau)_{\text{normalized}} = [1 / (G(0)-1) * (G(\tau)-1)] + 1$. Deactivating **Normalize** will display the normal correlation curve.

 Normalization only works for a curve, for which a fit has been conducted in **FCS Fit** and hence a $G(0)$ is available.

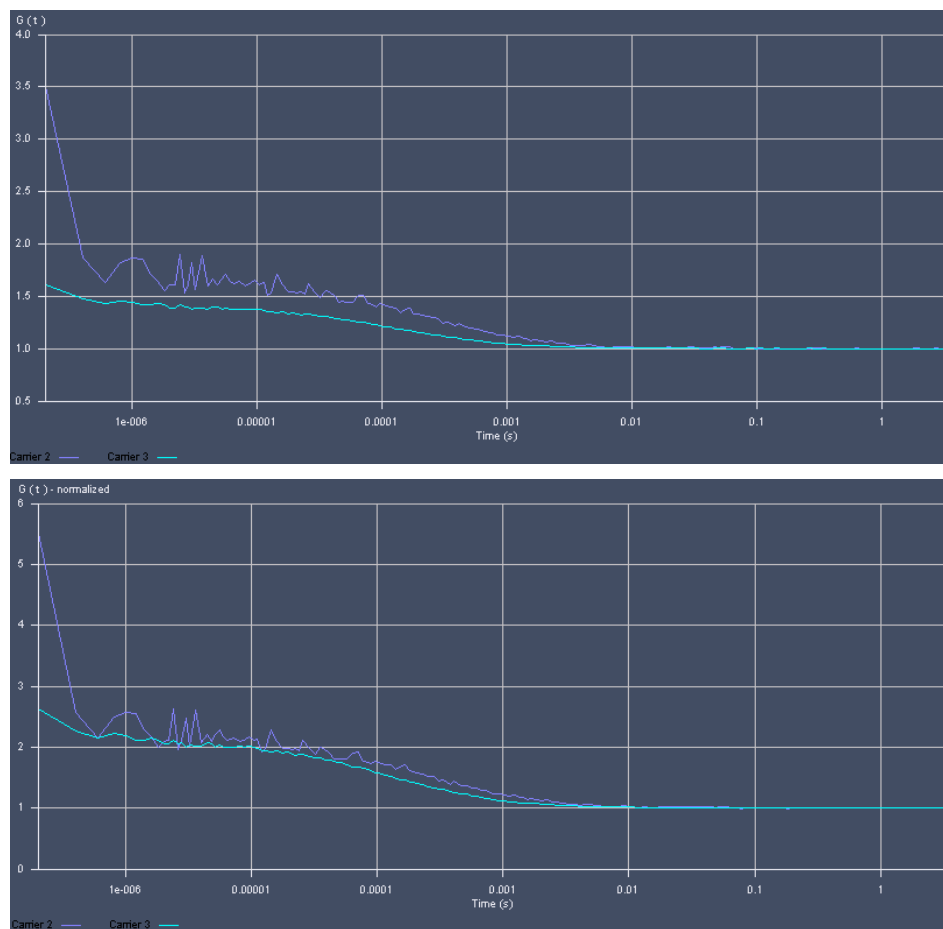


Fig. 93 The Correlation Curve window in normal (upper graph) and normalized (lower graph) display


(4) Photon Counting Histogram

This diagram (also called Photon Counting Histogram) shows the frequency plotted against the photon number in a certain time bin. To obtain this histogram, the number of pulses (or: photons recorded from the detector) in a moving time window are recorded and included in a histogram. You can determine the binning time in the **Measure** tool in **Processing** under PCH or if you load a raw data file with the **Reload** button.

You can zoom in the image by pressing the left mouse button and drawing a rectangle of the area you want to zoom in. If the button is disengaged, the zoom image is displayed.

By clicking the right mouse button you can choose between different options in the **Pulse density Histogram** context menu (Fig. 94).

- If you have zoomed in, you can go to the original image size by choosing the **Reset diagram zoom** option.
- **Copy text to clipboard** will copy the diagram coordinates into the clipboard, from which they can be pasted into other programs like Excel.
- **Write text to file** will store the diagram coordinates in a .txt file. You will be prompted to choose a name and a folder before saving.
- Choosing **Abscissa logarithmic** or **Ordinate logarithmic** will display the abscissa or ordinate in a logarithmic scaling.

 Note that with the ordinate set to a logarithmic scale, all zero frequencies will be displayed as vertical tabs, since the $\log 0$ goes to infinity low values.

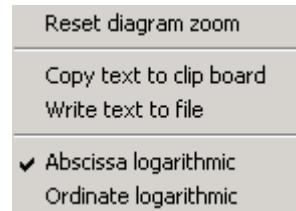


Fig. 94 PCH context menu

(5) Pulse Distance Histogram

This diagram shows the frequency plotted against the times elapsed between two subsequent pulses (or: photons recorded from the detector). To obtain this histogram, the time distance between two photons is evaluated from the raw data.

You can zoom in the image by pressing the left mouse button and drawing a rectangle of the area you want to zoom in. If the button is disengaged, the zoom image is displayed.

By clicking the right mouse button you can choose between different options in the **Pulse Distance Histogram** context menu (Fig. 95).

Reset diagram zoom will reset any zoomed image.

Copy text to clipboard will copy the diagram coordinates into the clipboard, from which they can be pasted into other programs like Excel.

Write text to file will store the diagram coordinates in a .txt file. You will be prompted to choose a name and a folder before saving.

Choosing **Abscissa logarithmic** or **Ordinate logarithmic** will display the abscissa or ordinate in a logarithmic scaling.

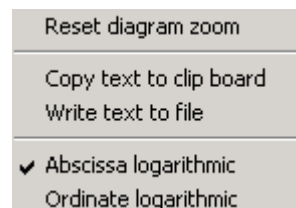


Fig. 95 Pulse Distance Histogram context menu

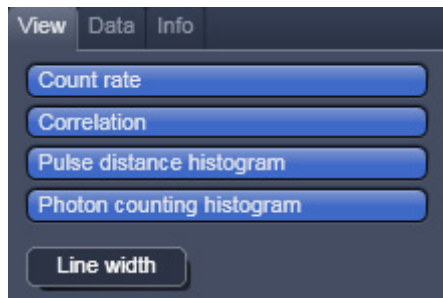


Fig. 96 View Options

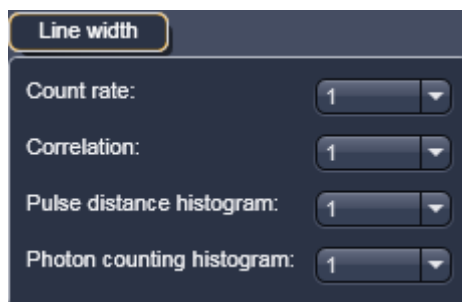


Fig. 97 Line width selection window

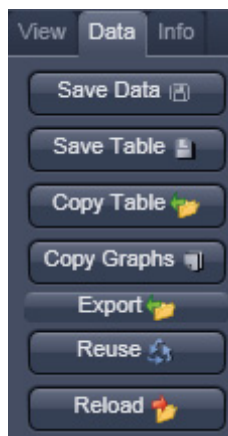


Fig. 98 Data Options

(6) Options / Correlation Diagrams

In the **Options / Correlation Diagrams** field you can handle files and displayed graphs.

Three submenus are available:

- View / View Options: Select / Deselect graphs
- Data / Data Options: File handling
- Info / Info options: Information on Method

(a) View

Click on the **View Options** tab to open the **View Options** menu (Fig. 96). Select / Deselect graphs to be displayed by pressing the corresponding buttons. This will alternatively activate / deactivate the button. The buttons are highlighted in blue for actively displayed graphs. Four graphs can be displayed: **Count rate** trace, **Correlation** function, **Pulse density histogram** and **Pulse distance histogram**. With Line width you can select the width of the diagram lines between 1 and 5 (Fig. 97).


Click on the **Data Options** tab to open the **Display Options** menu (Fig. 98). You have several options:


(b) Data

- **Save** allows you to save the whole data set (curves, fitting results, fit parameters, raw data) to a disk. If **Save** is pressed you will have the choice between **FCS data files (.fcs)** without raw data or **FCS files with raw data (.fcs)** attached by selecting the appropriate settings from the pull-down menu (Fig. 99).

 Note that raw data are only available, if the **FCS files with raw data was selected**.

The **Save FCS** menu offers the possibility of entering a file name in the **Name** field and to choose an appropriate **.Directory**.

 Note that it is only possible to store the data as ANSI text. Binary file formats of previous releases are no longer available.

 If **raw data** were saved along with the FCS file, the raw data of each single measurement channel will be stored attached to the .fcs file. .raw files will bear the same name than the .fcs file with name extensions, which identify the repetition and the channels.

 You can enter a sample comment in the **Sample Comment** display box by typing. This comment will be saved along with the data.

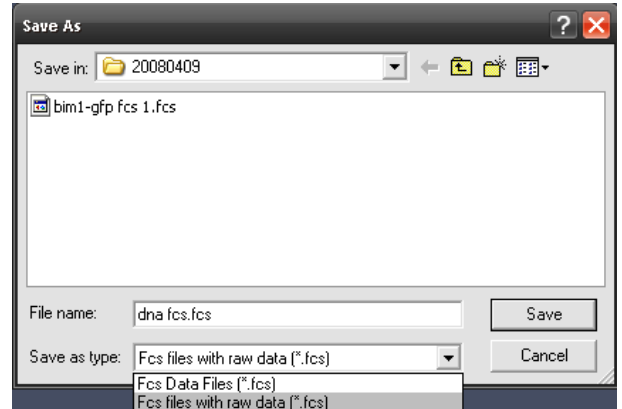


Fig. 99 Save Raw Data window

Save Table

With **Save Table**, the result table can be saved in a separate text file. If the button is clicked, a file menu will appear offering the possibility to select a directory and to enter a file name.

Copy Table

With **Copy Table**, the whole table will be copied to the clipboard. The contents of the clipboard can be used by most WINDOWS applications via the **Paste** function.

Copy Graphs

With **Copy Graphs** the displayed graphs will be copied to the clipboard. You can paste the graphs into other WINDOWS applications.

Export

With **Export**, the measured data will be exported in a ConfoCor 1-compatible format and can be handled using the FCS Access Fit program. In the **Export** window you can enter a name in the **File name** field and a type in the **Data type** field. In the **Save** pull down menu you can select a directory. You can specify if only the selected rows (highlighted), the Current row (the current selected one) or all rows are exported. Exported files can be opened again with the **Open FCS** button. All selected files will be loaded in one **FCS Correlation diagram**.

Reuse

With a click on the **Reuse** button, the configuration used to record the selected measurement will be loaded.

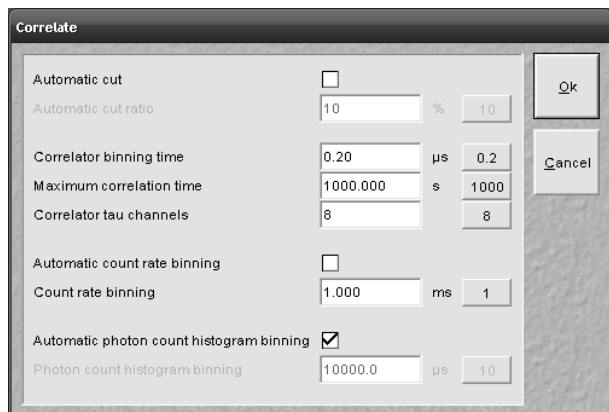


Fig. 100 Correlate window

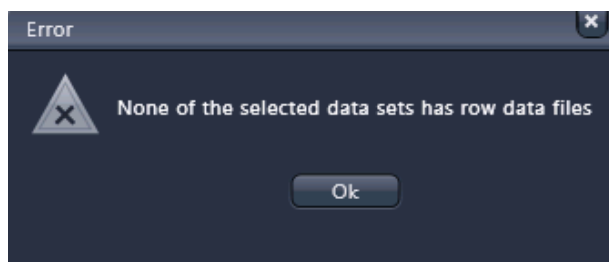



Fig. 101 Correlate Error window


Reload

With **Reload** the current active measurement will be reopened. If raw data have been stored and attached to the measurement the **Correlate** window will appear (Fig. 100).

You can redefine the following settings:

- Automatic dust filter
- Correlator settings
- Count rate settings
- Photon count histogram settings


 Note that only those measurements will be recalculated with the new settings which have been selected in the original table. All other measurements will open unchanged. To select all measurements use the table context menu opened with a right mouse click in the table and choose the line **Select all**.

 Note if no raw data have been stored or are associated with the .fcs file or the measurement, an error message telling this fact will be displayed (Fig. 101). No manipulation of the data is possible. Click **Ok** to continue working with the unmodified data set.

Automatic Dust Filter


If the **Automatic cut** box is checked, you can type in a threshold in % in the **Automatic cut ratio** display box. This sets the threshold intensity for an electronic dust filter. The value (0 ... 100) will define the threshold in percentage. A default value of **10 %** can be selected by pressing the button on the right.

If the integrated count rate over a certain count interval will exceed the average count rate by that threshold, this special interval is discarded for correlation analysis. For example, if the system detects a count rate in a certain time interval that exceeds the average count rate by over 30 % and the threshold was set at 30, this interval will be discarded for correlation analysis. The time intervals before and after the discarded region are separately correlated and the results averaged. These holds also true, if more than one region is discarded. In this case all the single regions that are separated by cut our regions are separately correlated and the resulting average will be displayed.

 Note, that calculation of an average will be performed at the beginning of the measurement. If peak count rates will come at the beginning, this kind of dust filter does not work. Also, due to the necessity to average signals over a certain integration time, more than only the peak area will be discarded. Another outcome of the necessity to average the count rate signal is that several small peaks following close to each other will be treated as a huge peak and might be cut out. This means, in the **Automatic cut** mode accumulated count rates rather than peaks are removed. For cross-correlation experiments, any of the regions discarded in either autocorrelation function will not be used. Cut off regions are framed by stippled boxes and appear matted in the **Count Rate** window.


Correlator Settings

You can determine the start value of the **Correlator binning time** in μs , the **Maximum correlator time** in s and the start value for the **Correlator tau channels** by typing the values in the respective selection boxes. Default values (**0.2** μs , **1000** s and **8**) can be loaded by pressing the corresponding default buttons on the right.

 The **Correlator binning time** determines the minimal bin time used in the correlation analysis and also the start correlation time, which will be identical to minimal bin time. The **Maximum correlator time** defines the end correlation time. It cannot exceed the measurement time and in the ConfoCor it will never exceed 2/3 rd of the measurement time. Hence, the value will only be used if equal to or smaller than 2/3 rd of the measurement time, if greater 2/3 rd of the measurement time will be used automatically. The **Correlator tau channels** define the number of linear increased Tau channels per multiple Tau step.

Count Rate Settings

You can either check the **Automatic count rate binning** box, in which case a dynamic binning is chosen, or deactivate the box and type in a value in ms in the **Count rate binning** selection box for a constant binning with the defined value. The default value of **1** ms can be loaded by pressing the default button to the right.

 If **Automatic count rate binning** is applied, the system averages three data points and rebinds then data in dependence of the measurement time. The diagram will have a mean with fluctuations above and below the mean. In constant binning, data points are not averaged. This will result in a baseline with fluctuations above.

Photon Counting Histogram Settings

You can either check the **Automatic photon counting histogram binning** box, in which case 32 histograms with different binning times are calculated and the one with the best dynamic range (three standard deviations) is chosen, or deactivate the box and type in a value in μs in the **Photon count histogram binning** selection box for a constant binning with the defined value. The default value of **10** μs can be loaded by pressing the default button to the right.

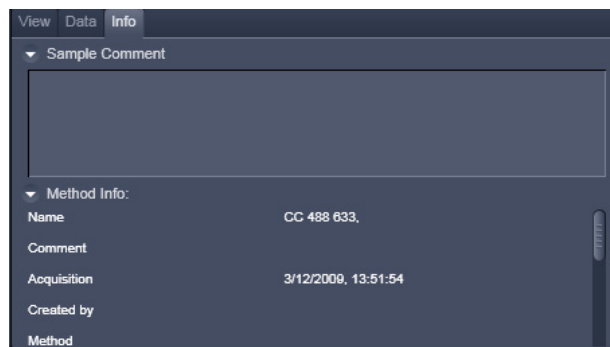


Fig. 102 Info options


(c) Info

- Click on the **Info** tab to open the **Info Options** menu (Fig. 102).
- Open the **Sample Comment** field by clicking the arrow to enter a comment in the comment box.
- Open the **Method Info** by clicking on the arrow to display the Meta data of the experiment.
- Close both fields by clicking the arrows again.

9.12.2.3 FCS Coincidence

The coincidence analysis generates a two-dimensional color-coded count rate histogram (Fig. 103) in this diagram. During the measurement the count rates in channel 1 (red) and channel 2 (blue) are registered in small time windows and the respective frequencies are calculated. The count rate in channel 1 is then plotted versus the count rate in channel 2. All values are incremented in the diagram and count rates occurring simultaneously in both channels will populate the diagonal of the diagram.

 All the table functions in the **Coincidence** mode are identical to those in the **Correlation** mode

 Note that the **Coincidence diagram is** currently only a display help and data cannot be exported. There are no options available for the Coincidence Diagrams. Coincidences can support analysis in case of rare event detection of a standard cross-correlation experiment, when the measurement time drops short for sufficient statistical significance, because it might be prohibitively long - as a rule of thumb; approximately 1000 transitions of a labeled species are required to generate a correlation curve of sufficient quality.

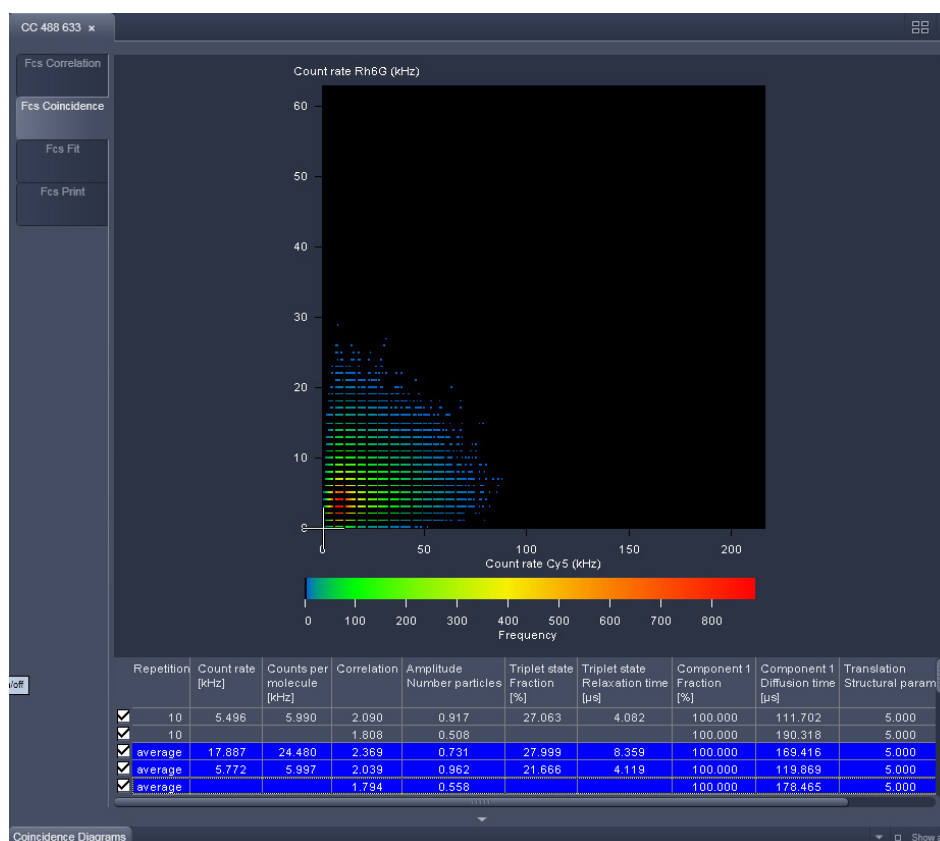


Fig. 103 Coincidence diagram panel

9.12.2.4 FCS Fit

- Click on the **FCS Fit** tab to activate the **Fit** display mode (Fig. 104).

In general this menu allows you to work with already measured and probably also fitted correlation curves. The intention is to have the possibility of performing other fit using different fitting parameters if the automatic fit did not yield optimal results.

The panel is divided in Diagrams, Result Table, Model Field and Fit action buttons.

(1) Diagrams

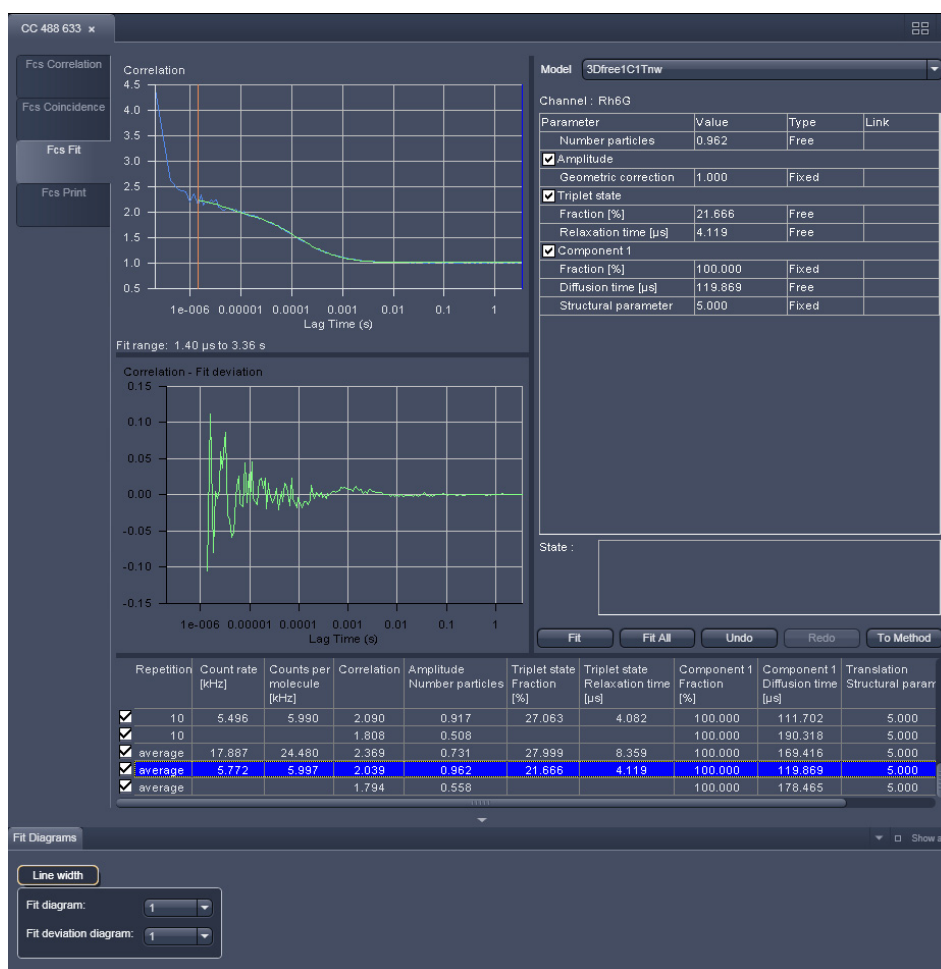


Fig. 104 FCS Fit diagram panel for correlation analysis

For fitting to a correlation model the upper graph (Fig. 103) shows the **Correlation $G(\tau)$ Fit diagram** (correlation plotted versus the correlation time) with the overlaid fit graph. It also displays the fit range defined by the red (start value) and the blue (end value) bars. The lower **Fit deviation** curve depicts the fit residuals. If an experiment is loaded for which no fit has been conducted yet, only the measured **Correlation $G(\tau)$** curve is shown and no overlaid fit curve. **The Fit deviation** diagram will be empty.

The **Line width** pull down menu allows to select the line width for the selected graph.

For fitting to a PCH model the upper graph shows the **PCH Fit diagram** curves (frequency against count rate per bin) with the overlaid fit graph. If an experiment is loaded for which no fit has been conducted yet, only the measured curve is shown and no fit curve. **The Fit deviation** diagram will be empty.

The **Line width** pull down menu allows to select the line width for the selected graph.

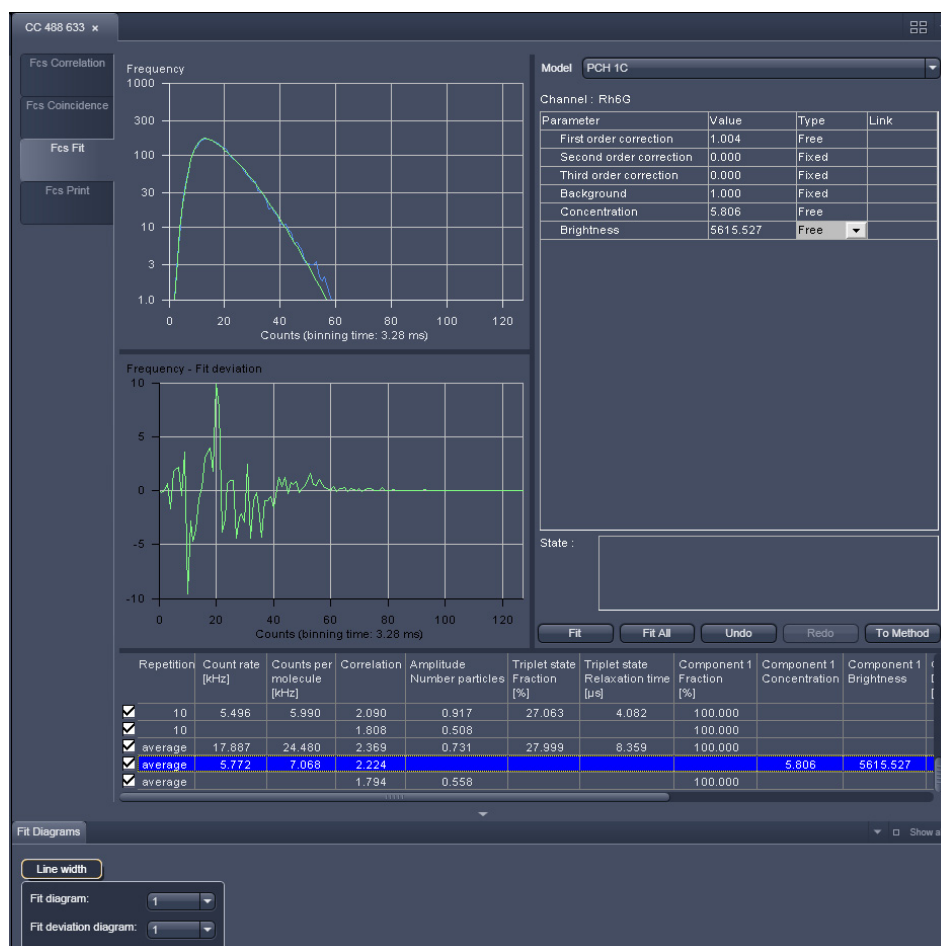


Fig. 105 FCS Fit diagram panel for PCH analysis

The **Zoom** function of the **Fit diagrams** can be used to display certain diagram areas of interest in an enlarged form:

- Use the left mouse button to click on the margin of an area of interest in the diagram, keep the mouse button pressed and draw a rectangular above the area of interest in any required direction. On release of the mouse button, the selected area is displayed in an enlarged form in the diagram. The scaling of axis is matched automatically.

The context menu can be used to reset the zoom to its original value, copy the data, and adjust the display.

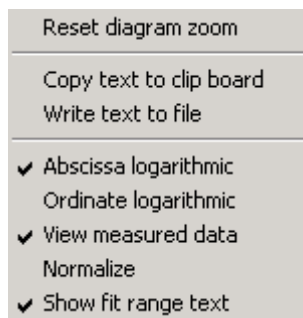


Fig. 106 Context menu of the Fit Correlation diagram

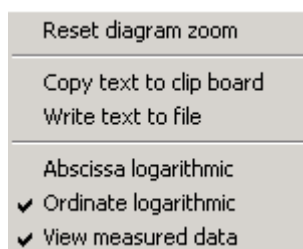



Fig. 107 Context menu of the Fit PCH diagram

- Click on the diagram with the **right** mouse button to open the context menu for the **Fit Correlation** (Fig. 106) and **Fit PCH** diagrams (Fig. 107), respectively.
- A click on the **Reset Diagram Zoom** with the **left** mouse button will reset the zoom value.
- Select the line **Copy data to clipboard** with a click of the mouse if you want to insert the data directly into other WINDOWS programs via the clipboard. The **Paste** function permits direct insertion of these data into the required program.
- Select **Write to file** to store the data in an external ASCII file (.txt). Only the coordinates of displayed curves are exported.
- Select **Abscissa logarithmic** or **Ordinate logarithmic** to scale the x- or y-axis, respectively, logarithmically.
- Select **View measured data** will display the measured Correlation or PCH curve in addition to the Fit curve. If this option is not selected, only the Fit curve is displayed.

 Each graph will rescale automatically.

- Select **Normalize** to display the correlation curves in a normalized form (Fig. 108). The amplitude of the diffusion contribution will be normalized to 2, not the total amplitude, if other term like triplet state were used in their normalized form. This option is only available for the **Fit Correlation** diagram.
- Select **Show fit range text** to display the start and end values of the fitted data of the correlation curve defined by the red and blue bars. The positions of the bars can be adjusted by drag and drop. This option and the bars are only available for the **Fit Correlation** diagram. **Start Channel** and **End Channel** determine which part of the correlation curve should be fitted to the model. The start and end position of the channels will be displayed as correlation times (in μsec) and not in absolute channel numbers, since those will change dependent on the **Correlator** settings defined in the **Measure's** tool in **Processing** panel.

The zoom function can be used to display certain areas of interest in the **Fit deviation** diagram.

- Use the left mouse button to click on the margin of the area of interest in the **Fit deviation** diagram, keep the mouse button pressed and draw a rectangular above the area of interest in any required direction. On release of the mouse button, the selected area is displayed in the diagram in an enlarged form. The scaling of axes is matched automatically.

The context menu of the **Fit deviation** diagram can be used to reset the zoom to its original value, copy the data, and adjust the display.

- Click on the diagram with the **right** mouse button. The **Fit deviation** context menu is opened.
- Click on the line **Reset Diagram Zoom** with the left mouse button to reset the zoom to its original value.
- Select the line **Scaling** to open the **Diagram** scaling window. Enter the required percentage value (from 1 to 100) for the scaling and click on **OK** to rescale, **Cancel** to keep the old value. The scaling of the $G(t)$ axis will be adjusted.

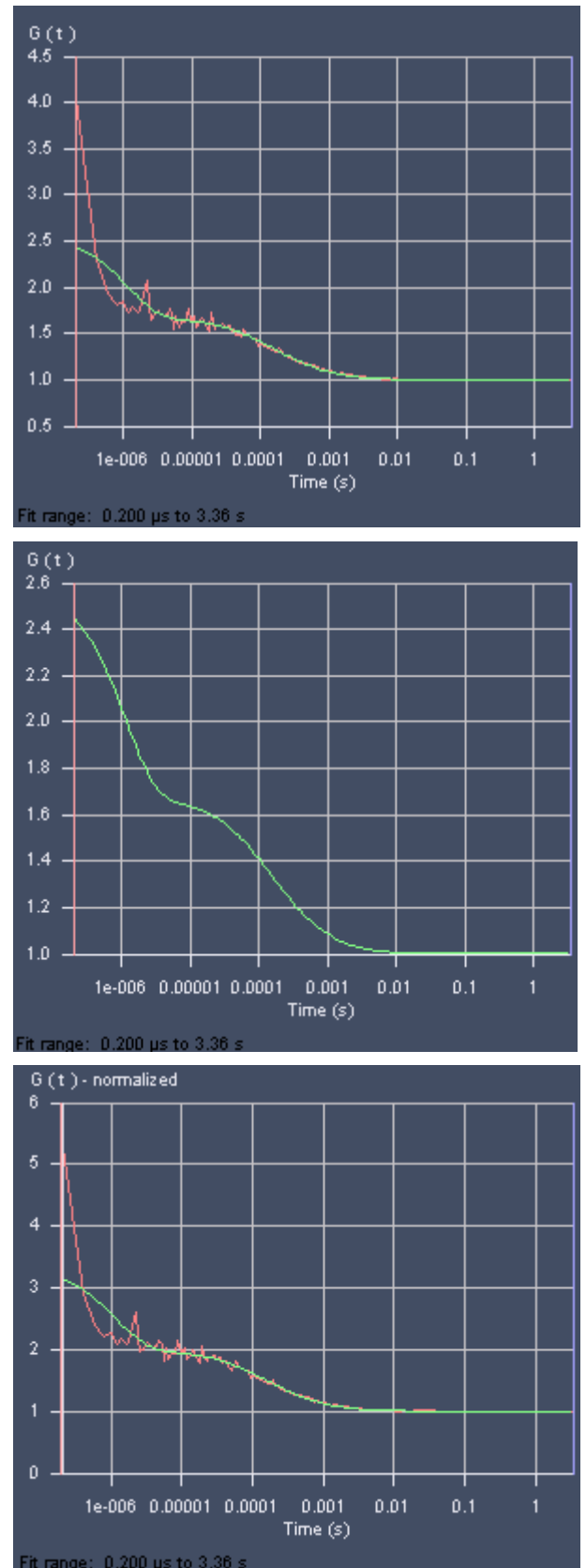


Fig. 108 Fit Correlation Curve (standard display), with fit curve only, in normalized form


- Select the line **Copy data to clipboard** with a click of the mouse if you want to insert the data directly into other WINDOWS programs via the clipboard. The Paste function permits direct insertion of these data into the required program.
- Select **Write to file** to store the data in an external ASCII file (.txt).

(2) Fit Table

The Fit Table displays the values of the fitted parameters and will be updated after the fit.

 All the **Fit table** functions in the **FCS Fit** mode are identical to those in the **Correlation** mode.

Measuring rows can be activated / deactivated by checking / de-checking the corresponding check boxes. Deactivation of these check boxes will exclude the relevant rows from all subsequent evaluation procedures. Average curves are updated in respect to the rows taken into consideration.

 Lower and upper limits are only displayed if selected. To select, click with the right mouse button into the result table (Fig. 109).

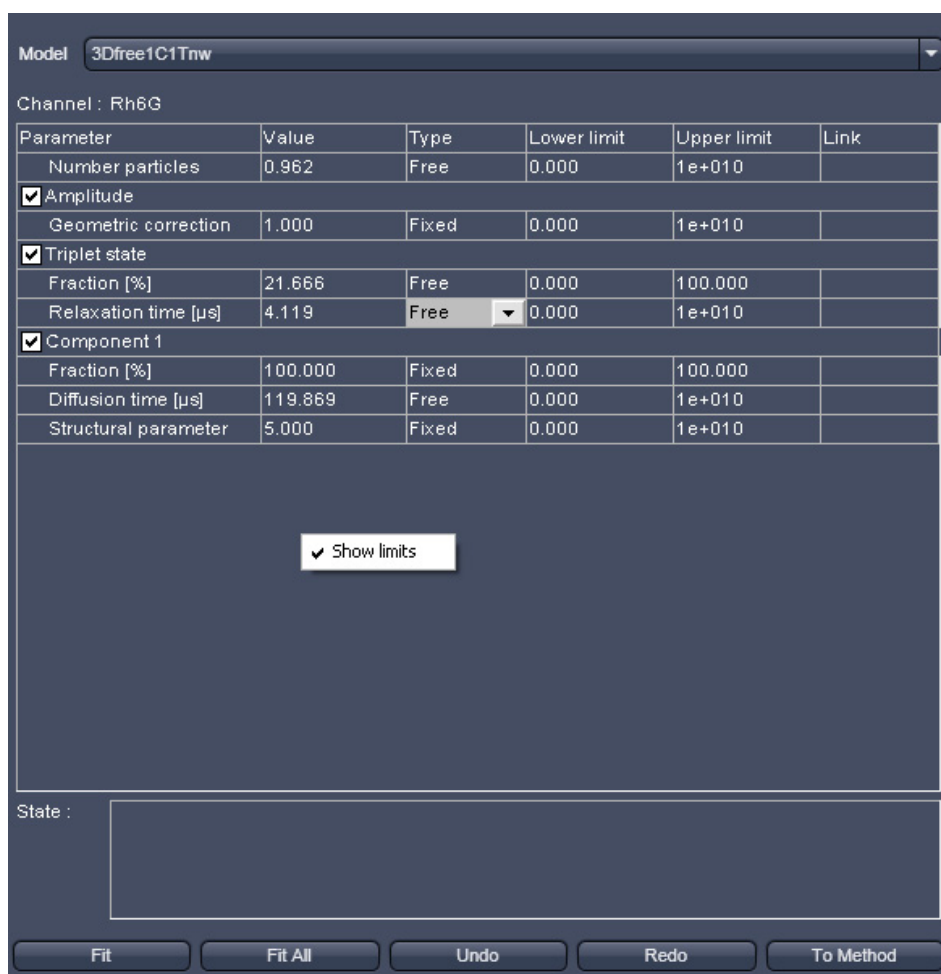


Fig. 109 Result table with the Show limits menu activated with the right mouse button

(3) Model Field

Load a suitable model from the **Model** pull down menu. The name of the model will be displayed in the **Model Display** box. All the terms and components of the model will be displayed in a tabular form. You can deselect and select terms by de-checking / checking the boxes on the left of each term.

All parameters belonging to one term are listed as a block in the **Parameter** column, which shows the term and parameter names.

The current parameter values are displayed in the **Values** column. You can edit a value by typing. The handling of the parameter is defined in the **Type** column. By clicking with the left mouse button in the respective field, a button tab becomes available. Use the arrow head to open the drop down menu. Three options for the parameter setting will become available (Fig. 110):



Fig. 110 Type drop down menu

- If you select **Free**, the parameter will be defined as free. After the fit, the field will contain the fit result for the parameter. The start values of the parameter (initial guesses) will be calculated by an algorithm.
- **Fix** allows you to fix the parameter. This is useful if you know its value from other measurements.
- **Start** will assign a start value to the parameter and leaves the parameter free to fit. In this case, no initial guesses will be made.

Upper and lower values for the fit parameters can be entered in the fields of the Upper limit and Lower limit columns. Defaults are the extreme possible values. If fit limits fall short or are exceeded, the fit will try to find another solution or will fail.

The global link status of a parameter is displayed in the Link column. By clicking with the left mouse button in the respective field, a button tab becomes available. Use the arrow head to open the drop down menu. Five options for the linking a parameter will become available (Fig. 111):

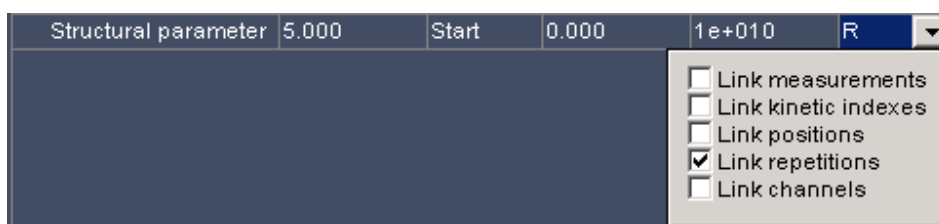



Fig. 111 Link drop down menu

- **Link measurement:** links a parameter from different measurements (abbreviated **M**)
- **Link kinetic indexes:** links a parameter from the same time points (abbreviated **K**)
- **Link positions:** links a parameter obtained from measurements at the same site (abbreviated **K**)
- **Link repetitions:** links a parameter for all repetitions of one measurement (abbreviated **R**)
- **Link channels:** link a parameter for the same channels (abbreviated **C**)

You can select the type of linkage by checking the corresponding boxes. More than one link can be activated. After closing the button tab, the linkage type is displayed as a one letter abbreviation. If a linkage is activated that does not apply for a measurement, it will be just disregarded. Global fitting will fit all linked parameters of different measurements to the same value.

- Select one or more rows in the **Fit Table**, for which you want to perform the fit. All curves of the selected row will be displayed. The last selected row will determine the channel that will be displayed in the **Channel:** display field. Note, PCH can be fitted only one-dimensional. If a cross-correlation measurement is activated, the PCH model will be automatically replaced by a correlation model.
- Set the range of the curves to be fitted by setting the red and blue bars in the correlation diagram (PCH diagrams do not have this option and the whole data set is always fitted). Press the **Fit** button to fit the loaded curves to the model. If you press **Fit all** all measurements with the same channel as the one displayed in the Channel: field will be fitted as well.

 Note, all other channels will not be fitted and the model has to be selected anew, if such a row with a different channel is selected.

(4) Fit Action buttons

The **Fit** action buttons enables you to perform a fit and adapt the fit process (Fig. 112).

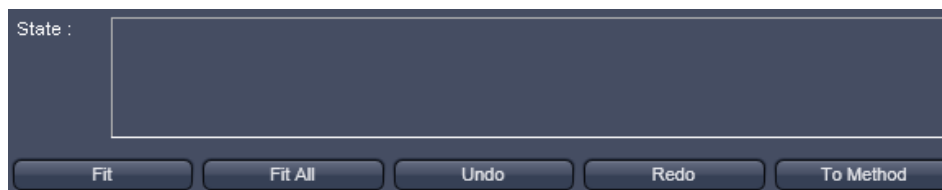


Fig. 112 Fit action buttons

Fit: will perform a fit for all highlighted measurements (rows) according to the loaded model.

When the fit is completed, the free parameters will be replaced with the new fitting results and the fit graph and result table will also be updated.

Fit all: will perform a fit for all measurements (rows) that have the same channel as the one displayed in the **Channel:** display field. All other channels will not be fitted. If you change to a row with a different channel, the last assigned model will load for that row.

Undo: cancels a previous command. Repeatedly pressing will cancel commands in the reverse of their execution.

Redo: re-executes a previously undone command. Repeatedly pressing will re-execute previous undone commands in the order of their previous execution.

To Method: writes the current displayed **Model** settings into the method. Hence parameter values and their type of the selected fitting model are assigned to the model used in the current method. If you want to keep the changes permanently, the Method has to be stored in the **Measure** tool's **Save Info**.

The **State** display box informs you about the fitting conditions. The quality of the fit is displayed in the **chi²** display box of the **Fit table**. The X^2 (chi²) value should approach zero for highest quality.

9.12.2.5 FCS Print

Click on the **FCS Print** tab to activate the **Print Preview** display mode (Fig. 113).

The **FCS Print Preview** window shows an overview of the results presented in tables and / or graphs, and relevant measuring parameters. This result overview can be printed directly on a connected printer.

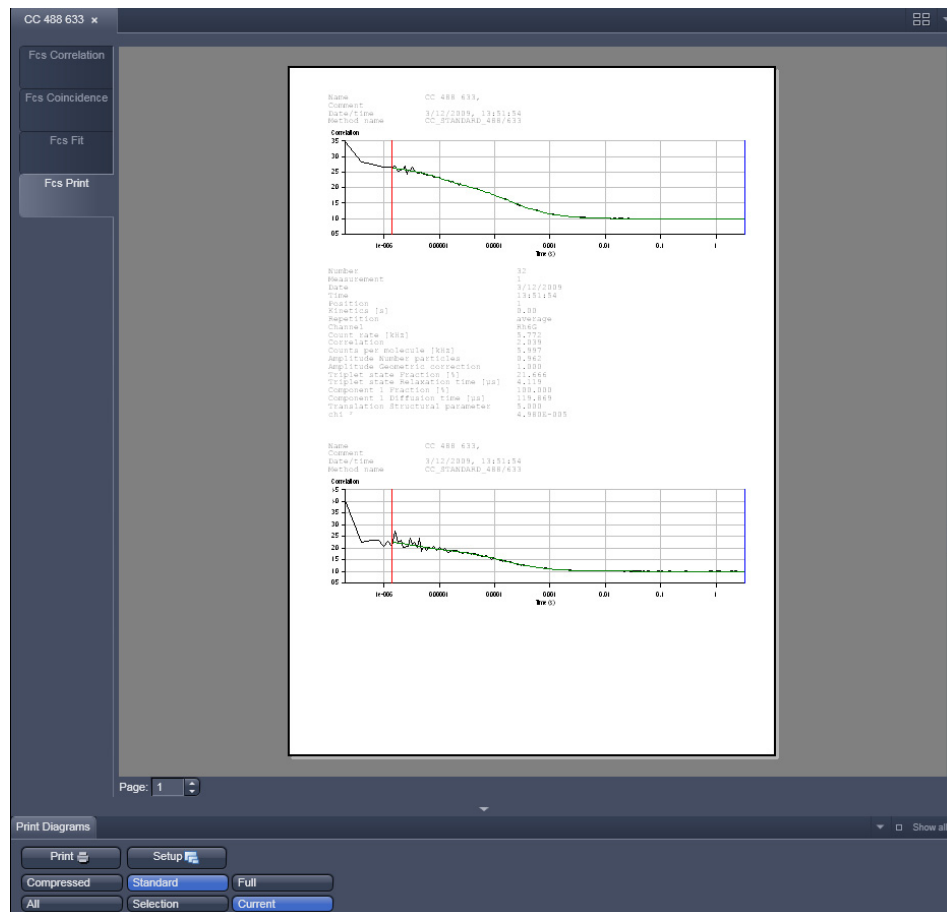


Fig. 113 FCS Print panel

In the **Options / Print Diagrams** the following print functions can be selected by pressing the corresponding button:

Print: Starts the print function.

Setup: Opens the printer setup window to set the print parameters.

Landscape: Selects **Landscape** paper orientation.

Portrait: Selects **Portrait** paper orientation.

Compressed: Selects the **Compressed Report** preview without diagrams.

Standard: Selects the **Standard Report** preview with correlation and fit curves.

Full: Selects the **Full Report** preview with all diagrams and tables.

All: Prints all measurements.

Selection: Prints all selected / highlighted measurements.


Current button: Prints the last selected / highlighted measurement only.


To print a report, proceed as follows:


- Select the **Compressed**, **Standard** or **Full** button.
- Select the **All**, **Selection** or **Current** button.
- Click on **Landscape** or **Portrait** for paper orientation.
- If required, change the printer settings using the printer **Setup** button.
- Click on **Print** to start the print procedure.

9.12.3 XYZ-Scan

- Press **xyz-Scan** to start a Scan as defined in the **X-Y-Z Scan tool**.
- This opens the **Count Rate Scan** window.
- The focus is now moved either in the x, y, or z direction or a combination of two (xy, xz and yz) in dependence of what button is active over the pre-selected distance. During the scan the count rate is displayed for the selected channels. Dependent on the scan modalities the count rates for the selected channels are plotted in a line plot (x, y and z) (Fig. 114) or frame plot (xy, xz and yz) (Fig. 115). In the frame plot intensities are color coded. The maximum intensity in Hz is displayed in the **Maximum count rate channel 1** and **2** display boxes.

 Please note, that x and y scans are performed by the stage regardless if the Scanner button is pressed or not in the **Measurement** tool group. Z scans are performed by the nosepiece.

 Scans will be performed relative to the actual position. The actual position will always be displayed as the 0 coordinates.

 A maximum (or minimum) in the resulting curve or plot usually indicates a region of interest.

- When the scan has been finished, the vertical black line (line plot) or the cross-lines (frame plot) can be used to re-position the focus. Just drag the bar or cross-lines with the left mouse button held down to the new position and release the mouse. By clicking the **OK** button the stage or nosepiece will move to the new position and the Scan window closes. The **Abort** button will be inactivated for a finished scan. You can press **Ok** or **Abort** during the scan. Ok will close the window and the old position is kept. Abort does not close the window, so you are still able to reposition. Press **Ok** to leave the Scan window.

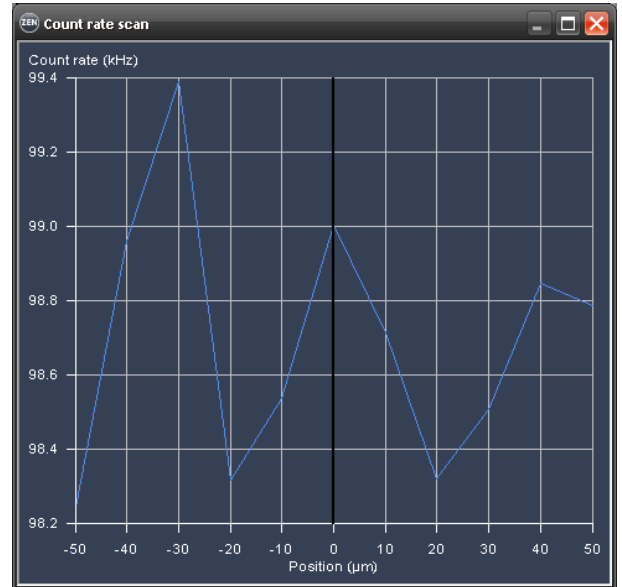


Fig. 114 Z-Scan result window (line plot)

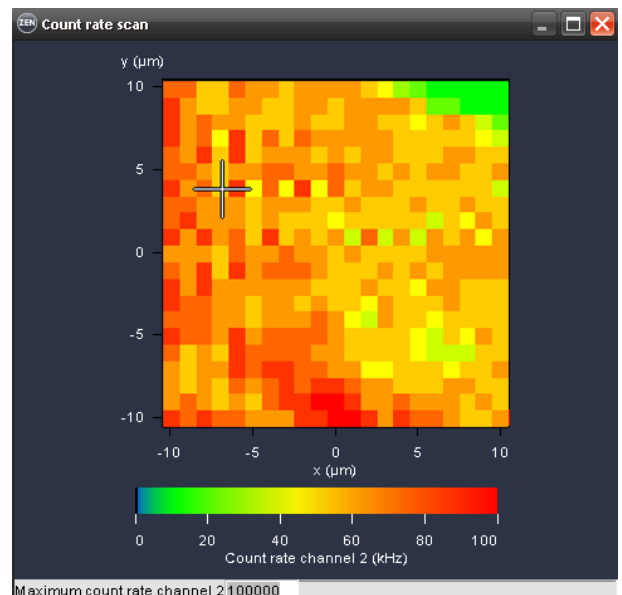


Fig. 115 XY-Scan result window (line plot)

The data of the **Count rate scan** window can either be copied to the clipboard or written to a text file. A click in the **Count rate scan** window with the right mouse button will open the context menu for line or two dimensional scans.

- Select the line **Copy data to clipboard** with a click of the mouse if you want to insert the data into other WINDOWS programs directly via the clipboard. The Paste function enables you to insert these data directly into the required program.
- Select **Write text to file** to save the data in an external ASCII file (.txt).

You can zoom in by spanning with the mouse left mouse button held down a region of interest (not available for a frame plot). You can rest the zoom by selecting the line plot by defining the zoom area with.

Z-Scan for finding a labeled cell membrane

The Z-scan is especially appropriate to position the confocal volume on a cell membrane. Due to the shape of the confocal volume, the membrane should not be approached from the side but instead rather from the top of the cell. Please note that it is better to use the upper membrane for measurement, since the lower membrane might be too close to the glass bottom surface resulting in disturbing reflections. Besides using the **Z Scan** you can also position the membrane manually, albeit with less precision.

(1) Manual Focusing on the Membrane

- Acquire an image of the cell.
- Place the focus above the cell and scan continuously.
- Focus slowly down until you see a fluorescence signal.
- Stop focusing.

Due to its high sensitivity ConfoCor 3 can still detect signals that cannot be imaged by the LSM. If the signal is too low for imaging, the membrane can still be detected using the **Z Scan** feature.

(2) Focusing on the Membrane by a Z Scan

The **Z Scan** measures the count rate at previously defined x, y positions. It is performed without table movement, which is at the fixed position of the laser beam.

- Acquire an image of the cell, focus through manually and select an equatorial section (middle of cell). Optional: Perform a **Z Stack** that includes the membranes of the cell with the LSM and select an equatorial section.
- Go to the **Measure** tool to **Acquisition** and the **Positions** submenu. Position the region of interest at the site of the fixed laser beam in **Current Position** using the **Crosshair** or use the crossline in the **LSM image** to mark the position. In the latter case, **Scanner** must be active, since the **XY-Stage** will approach the marked position only during a measurement!
- Go to the **X-Y-Z Scan** tool and activate **Z**. The **Z Scan** display shows the current Z position of the laser beam.
- Select the **Start** and **End Position** and enter the **Step Distance**. If you have chosen an equatorial section going 10 μm up and 10 mm down from the displayed current position are good values to start with. Also a step distance of 0.5 μm should work well.

- Press the **xyz-Scan** ConfoCor action button to perform a z scan. The z scan is performed and the measured intensity is displayed in dependence of the Z position (Fig. 116). The red line in the diagram shows the actual z position. Peaks (normally 2 from the two lower and upper membranes) show levels of high signal intensity and may correlate to labeled membranes. Note, that if the glass surface happens to be in the z-scan range it will also give a peak. To determine its position, just perform a z scan at a position where there is no cell. If the glass reflection contribute so much that the peaks of the membranes are hidden due to scaling, you have to shorten the lower range end. Place the red line at the peak that corresponds to the membrane to select this z position. Note that z-scan is performed relative to the current position, which will be assigned to 0.
- If no clear signal can be detected, or the peak of interest lies too close to the border, close the **Scan** window and perform a new z scan. Choose a different z range by modifying start and end positions to values that lie closer to the position at which the signal should be expected.
- If the z position has been selected, close the **Z-scan** window by clicking on the **Close** button.
- Press the **Snap** or **Start ConfoCor Experiment** action buttons to perform an FCS measurement. The FCS measurement is performed at the same X/Y position as the Z scan.

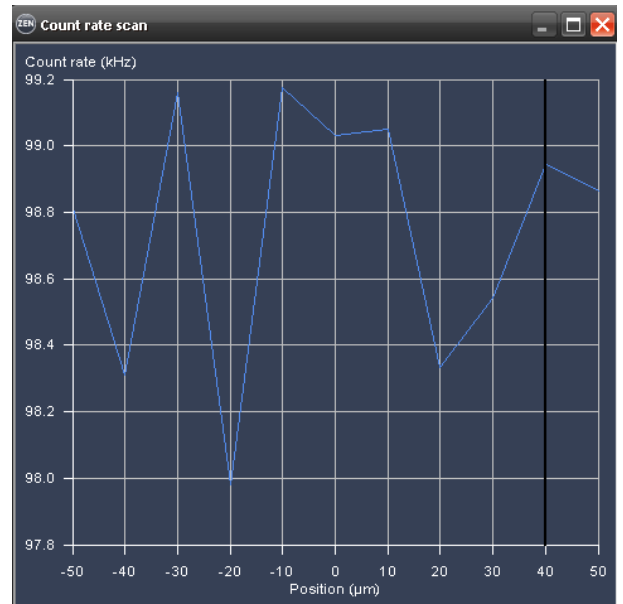


Fig. 116 Z scan image

9.12.4 Snap, Start ConfoCor Experiment, Stop




Fig. 117 FCS Correlation window during data acquisition

Start and end of a measurement

After setting the parameters the measurement can be run.

- Click on the **Snap** or **Start ConfoCor Experiment** action buttons to start the measurement and data analysis process. If **Snap** was chosen, exactly one measurement at the first **Carrier** or highlighted **LSM Image** position will be performed. If Start was selected, measurements will be performed on all selected positions in a sequential manner.

 Status lines at the bottom of the data evaluation window and in the **Open Image** display area show the progress of a current measuring procedure online. For non saved modified data a warning sign (orange triangle) will be displayed in **Open Images** (Fig. 118).

- Click on the **Stop** button to end the measurement. Only complete measurements will be available for storage; the interrupted measurement will be lost.
- Save the data in the **File** menu.

(1) Positioning in solution

- Align a carrier in the **Carrier Position** tool. Focus into the solution.
- Go to the **Measure** tool and the **Acquisition** panel. Choose Current Position or Sample Carrier and select the well(s) you want to take the measurement in.

(2) Positioning in a cell

Before positioning you have to select appropriate cells and image those. An overview of fluorescent expressing cells is best achieved by using the binoculars in transmitted and epi-fluorescent mode. Once cells with adequate expression levels have been identified they can be imaged with the LSM. Alternatively, suitable cells can be searched by using low zoom values in the LSM.

Visual inspection of the cells via binoculars

- In the major toolbar activate the **Ocular** button

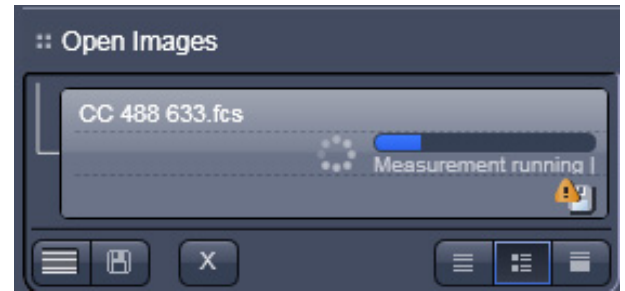


Fig. 118 Open Images with measurement in progress

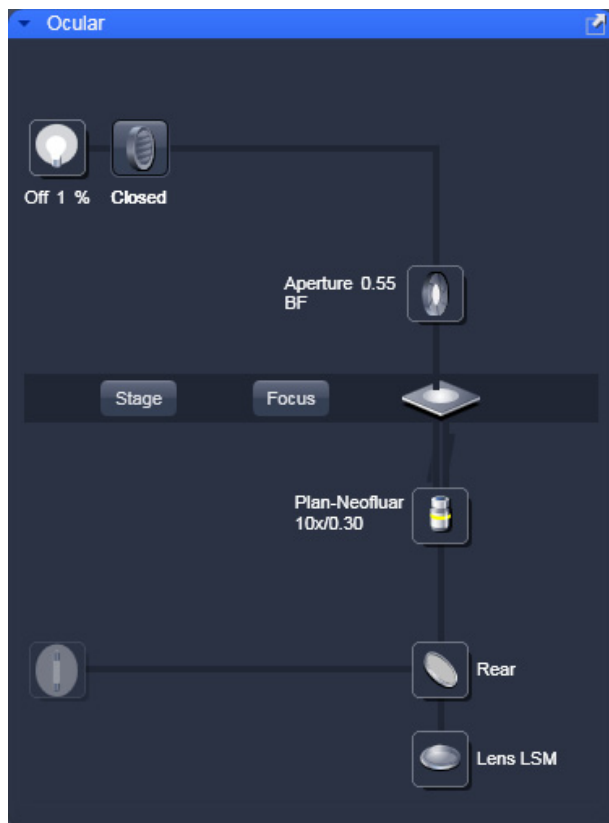


Fig. 119 Light Path - Ocular tab

- Choose in the LSM **Light Path** the register **Ocular** (Fig. 119)

The **Ocular** panel permits motorized functions including objective and reflector change settings as well as the illumination mode like transmitted or reflected light of the connected microscope to be controlled via the software.

☞ These microscope functions can also be operated directly on the microscope stand via assigned buttons or through the touch screen, if available. In that case, any changes are recorded by the software and displayed in the relevant windows / panels.

☞ For side and base port systems, the reflector has to be on a none position.

The **Ocular** panel contains the following functions:

HAL On/Off button for transmitted light: If the button is pressed, the control panel appears and the shutter automatically opens (Fig. 120). If you press the **On** button, the light intensity of the HAL lamp can be varied via the input box or slider. The Light Path will be highlighted by color in the diagram. Press the **On** button again to shut down the light. The color temperature for photo documentation can be switched on via **3200 K** button.

HAL Transmitted light Open/Close shutter button: The shutter for transmitted light from the HAL lamp is switched on and off by repeated pressing.

Condensor button: The Numerical aperture of the condenser is set via input box or slider. The turret position can be selected from graphical pop-up menu (only for motorized condensers).

Stage button: If the stage button is pressed, the Stage control panel will appear (Fig. 121). By pressing the **Stop** button you can interrupt any stage movement. The **Move to Zero** button will move the stage to the current zero positions of the x and y coordinates. The compass rose will move the stage in the direction of the arrowheads. Fast movement is obtained with the outer rose, slow movement with the inner rose. The **X-Position (μm)** and **Y-Position (μm)** display boxes show the actual x and y coordinates. You can edit the numbers by typing or using the arrowheads. If numbers were altered, the first click on the compass rose will bring the stage to the altered position. The **Step Size (μm)** display box show the currently use step size for stage movement. The value can be edited by typing or using the arrowheads. The **Zero Position Set** button set sets the x and y coordinates to 0.

Focus button: If the focus button is pressed, the Focus control panel will appear (Fig. 122). The **Z-Position** display box shows the current z position. The number can be edited by typing or using the arrowheads. The nosepiece or stage will automatically update the new position. By pressing the **Stop** button, you can stop the current movement. The **Step Size (μm)** display box show the currently use step size for stage movement. The value can be edited by typing or using the arrowheads. The **Home** button sets the z position to the predefined 0 value. Pressing **Load** will lower the nose piece (z-position) for objective change. **Work** brings the z-position back to the actual used position if the focus was zeroed or in **Load** position. Home and Load positions can also be accessed from the z-position slider by pressing

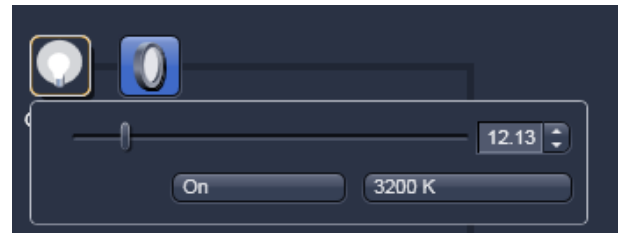


Fig. 120 Light Path - Ocular panel



Fig. 121 Light Path - Ocular panel, Stage

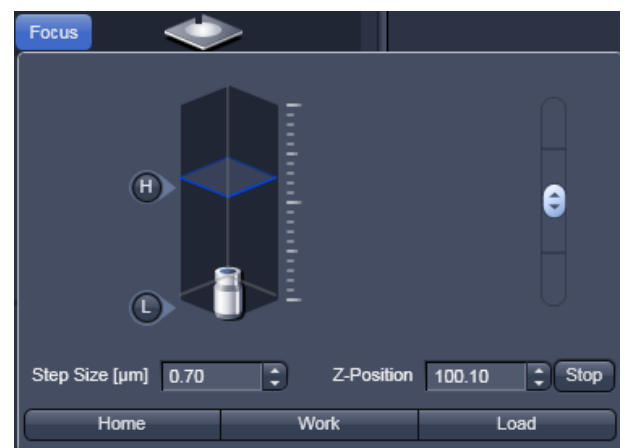


Fig. 122 Light Path - Ocular panel, Focus

the **H** or **L** buttons. The z position can be altered by grasping and sliding the **plane** or by using the arrow slider. The **plane** shows the actual z-position.

Objective button: The objective can be selected via graphical pop-up menu. Please note, that for FCS only the C-Apochromat 40x/60x W N1.2 are specified.

Reflector button: The reflector cube can be selected via graphical pop-up menu.

Tube Lens button: The tube lens can be selected via graphical pop-up menu.

HBO Reflected Light Open/Close Shutter button: The shutter for reflected epi-fluorescent light from the HBO lamp is switched on and off by repeated pressing. The light path will be highlighted in color.

For transmitted-light observation

- Switch the HAL lamp on by the **HAL On/Off** button and adjust the light intensity.
- Activate the condensor function with the **Condensor** button.
- Swing the required objective for FCS measurements into the working position. This is performed the **Objective** button.

For Reflected-light Observation (Epi-fluorescence)

- Turn on the HBO power supply switch.
- Switch the HBO **Reflected Light Open/Close Shutter** into the Open position.
- Select the desired filter in the reflector turret using the Reflector button by clicking on it. The filter is automatically moved into the beam path to enable observation in epi-fluorescence.
- Select the desired tube lens using the **Tubelens** button by clicking on it. Normally, the correct Lens 1x will be automatically chosen when the **Ocular** button of the major tool bar is pressed.
- Swing the required objective for FCS measurements into the working position. This is performed by selecting the objective with the **Objective** button. We recommend to use the C-Apochromat 40x/1.2 W corr on account of its optimized optics.

Imaging with the Laser scanning microscope

- In the major toolbar of the left toolbar area activate the **Acquisition** button (Fig. 123).
- Open in the LSM **Setup Manager** tool group the **Light Path** tool and choose the register **Acquisition** (Fig. 124). You have access to the ConfoCor beam path only in the **Show all** mode.

Here you can open the APD beam path menu by opening the APD beam path window. Set the laser and filters according to the dye and activate the corresponding channels.

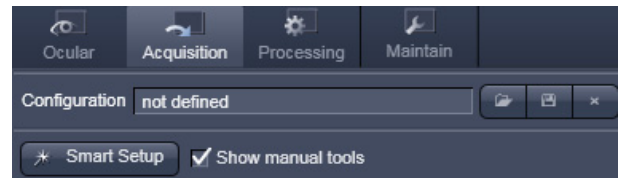


Fig. 123 Left toolbar area - Acquisition

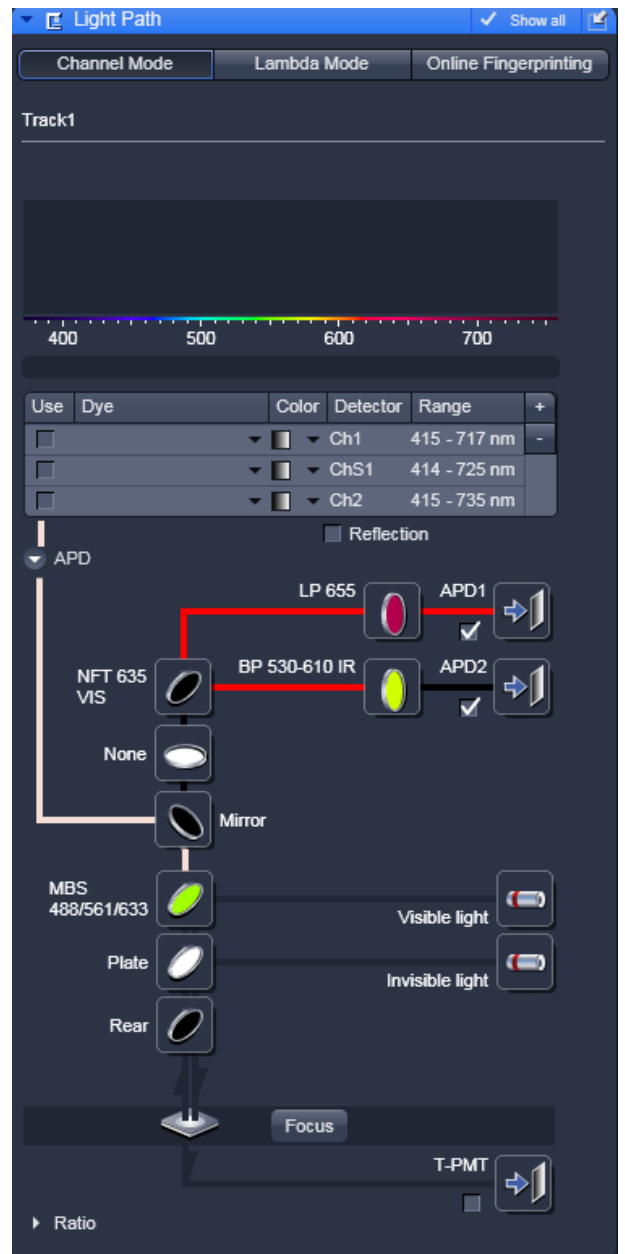
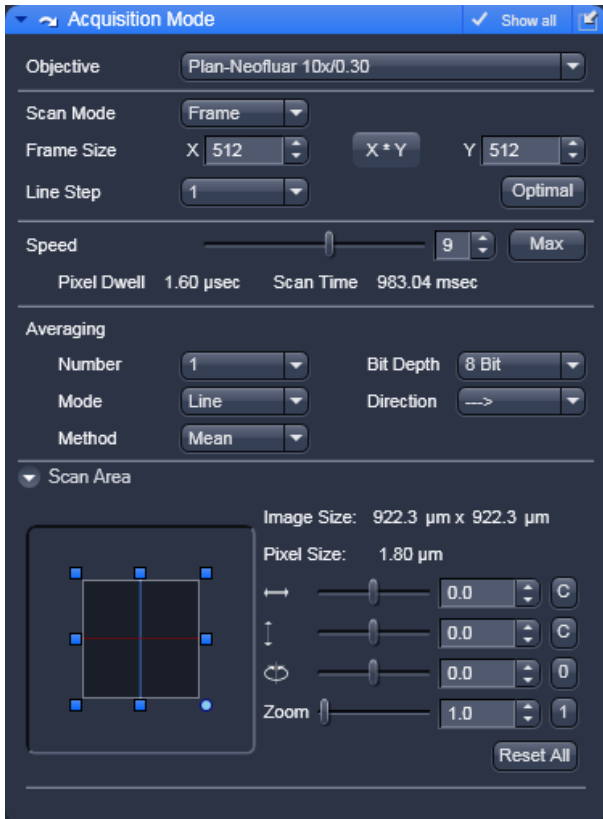


Fig. 124 Light Path - Acquisition



- Open in the **Online Acquisition** tool group the **Acquisition Mode** tool (Fig. 125). Here you can select the objective, scan modes, frame size, speed, averaging conditions and the zoom.
- Open in the **Online Acquisition** tool group the Channels tool (Fig. 126) and set the pinhole diameter (1 Airy Unit recommended), gain and amplifier offset. Select the required laser line and set the AOTF transmission. You can press the Find button to let the system optimize on the required gain.
- Press the LSM **Scan** action button to start a continuous scan. Optimize the laser settings while observing the image. If required refocus and reposition your sample.
- Either manually position the site of interest using **Current** in the **Measurement** tool's **Position** menu, or approach defined positions automatically in **LSM Image**.

Fig. 125 LSM Acquisition Mode tool

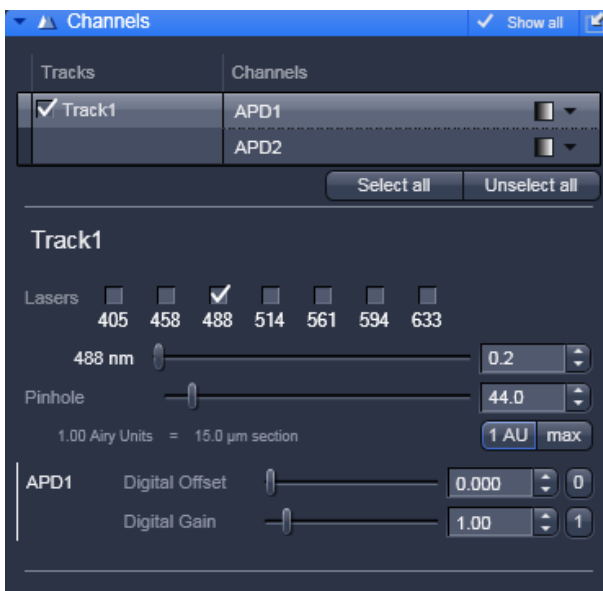


Fig. 126 LSM Channels tool

9.13 Options

In the major tool group window activate the **Maintain** register (Fig. 127). This will display the **Maintain** and **Options**. Open the **Options for ConfoCor** menu. The menu has four registers:

- Data,
- Measure,
- LSM + ConfoCor,
- Auto Save.

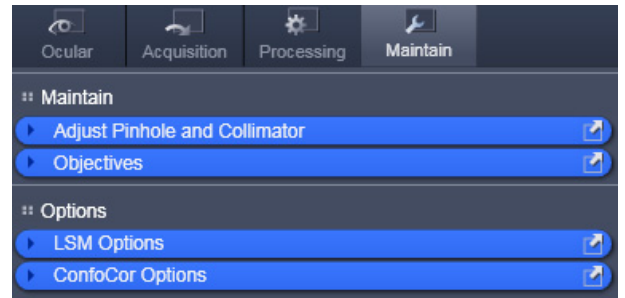


Fig. 127 ConfoCor Options

9.13.1 Data

9.13.1.1 Saving Raw Data During Measurement

If the **Save raw data during measurement** check box is activated (Fig. 128), raw data will be saved temporarily in a specified directory on disc (Fig. 129). Each single measurement will be saved in a single raw data file. The name of the raw data file is an identifier to the .fcs measurement it belongs and the channel. This option is used when access to the raw data is required to analyze the data in a different way in respect to correlation and PCH settings or within other programs.

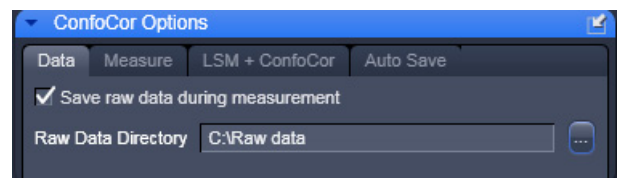


Fig. 128 ConfoCor Options - Data

If the check-box is de-activated, no raw data will be saved.

Temporary raw data will be deleted from the specified file upon closing the Image FCS diagram. You will be prompted in the **Save raw data** dialogue box, if you want to save the raw data. Press **Yes** to save the raw data permanently along with the .fcs file in a specified directory, which can be defined in the **Save** dialogue box. Press **No** to discard the raw data. Note that raw data are saved along with the .fcs measurement file in the same folder. They are attached to the .fcs file via a relative file path. If you save the same measurement again without the option **Save Raw Data**, than the raw data files will be reassigned an absolute file path and the connection to the .fcs file is lost.

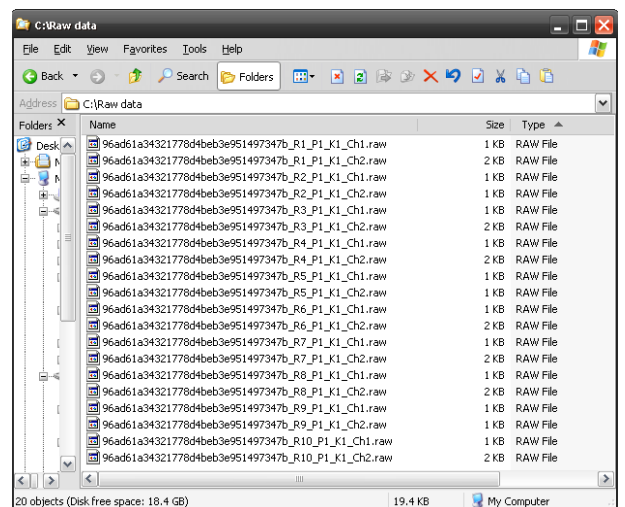






Fig. 129 Stored temporary raw data

Please note, if the **Auto safe** checkbox is ticked in the **Auto Save** submenu, temporary raw data will be stored permanently and have to be deleted manually. Care has to be taken to avoid disc space limitations, since raw data files can be huge.


-  Each single measurement is stored in one raw data file. For two channel experiments, each channel will be stored in a separate file.
-  The names of the raw data files are identical to the .fcs measurements, when stored along with them plus an extension that characterizes the measurement. Temporarily stored raw data do not contain the measurement name and have only the extensions.
-  If you store a measurement along with the raw data, but than a second time without, the connection between the .fcs and .raw files is lost. Instead of a relative directory location an absolute directory location is assigned to the .raw data files. When opening the .fcs file, no manipulations will be possible in this case.
-  You can open raw data in the File menu of the **Main tool** bar. You can either open the whole .fcs measurement, in which case all raw data will be loaded, or you can select single .raw data files.

9.13.1.2 Raw Data Formats

The following raw data formats exist:

- ConfoCor 1: FCS Access Rel 0.x and 1.x: No raw data format available
- ConfoCor 2 (&3): LSM Rel. 2.x and 3.x
- ConfoCor 2 & 3: LSM Rel. 4.x and ZEN 2008

Raw data files can be opened directly. They are also opened automatically if linked to an .fcs measurement. In this case all raw data files associated with the .fcs file will be opened in the same window.

-  Raw data are stored permanently. Since the internal clock runs at a clock rate of 20 MHz a maximum data rate of 10 Mbyte/s is achieved. If no pulses are recorded, the clock rate drops to approx. 155 Kbyte/s according to counter overflows.

ConfoCor 2 LSM Rel 2.x and 3.x

The data format is an exact representation of the dual channel photon trace within the limits given by the digitalization. This means that the data are recorded without losses within these limits.

The basic idea is to record the time between subsequent pulses from the detector in units of elapsed clock cycles (run length encoding). However, the format is modified to conserve space at high count rates and to be capable to handle dual channel data.

Data will be recorded in 16 bit words. Whenever a pulse is detected or the counter counting the clock cycles overruns 255 (FF hex), a word will be recorded. The word will contain information how many clock cycles elapsed (1 ... 255) since the last word had been recorded and additionally what happened in the four cycles of data generation *bt1* ... *bt4*.

The recorded word has the following structure (Fig. 130):

Bit	Meaning
0 (LSB) ... 7	clock counter value (starting at 1) during the triggering event trigger events are pulse recordings or counter overruns zero is reserved and only transmitted at the end of the measurement
8	1, if pulse recorded in channel 1 during cycle bt1; else 0
9	1, if pulse recorded in channel 2 during cycle bt1; else 0
10	1, if pulse recorded in channel 1 during cycle bt2; else 0
11	1, if pulse recorded in channel 2 during cycle bt2; else 0
12	1, if pulse recorded in channel 1 during cycle bt3; else 0
13	1, if pulse recorded in channel 2 during cycle bt3; else 0
14	1, if pulse recorded in channel 1 during cycle bt4; else 0
15 (MSB)	1, if pulse recorded in channel 2 during cycle bt4; else 0

Fig. 130 Structure of the recorded word

Two examples should make the format clear (Fig. 131). The tables show part of the running pulse train (from left to right) divided into clock cycles. "1" in the corresponding box indicates that a pulse arrived in this cycle. The "counter" row shows the counter readings. The lowest row indicates when the word has been recorded.

				bt1	bt2	bt3	bt4								bt1	bt2	bt3	bt4			
CH 1				1		1						...									
CH 2					1							...									
counter	120	121	122	123	0	0	0	1	2	3	4	...	254	255	0	0	0	1	2		
							↑ W1											↑ W2			

Example 1

				bt1	bt2	bt3	bt4								bt1	bt2	bt3	bt4			
CH 1				1		1						...				1					
CH 2												...					1				
counter	120	121	122	123	0	0	0	1	2	3	4	...	254	255	0	0	0	1	2		
							↑ W3											↑ W4			

Example 2

Fig. 131 Examples of the recorded word

Example 1 - The following words will be recorded:

- at W1:
high byte: 00011001(bin) = 19 (hex); low byte: 123 (dec) = 7B (hex); resulting word = 7B19 (hex)
- at W2:
high byte: 00000000(bin) = 00 (hex); low byte: 255 (dec) = FF (hex); resulting word = FF00 (hex)

Example 2 - The following words will be recorded:

- at W3:
high byte: 00010001(bin) = 11 (hex); low byte: 123 (dec) = 7B (hex); resulting word = 7B11 (hex)
- at W4:
high byte: 00100100(bin) = 24 (hex); low byte: 255 (dec) = FF (hex); resulting word = FF24 (hex)

The first 30 bytes of the raw data file contain the comment "ConfoCor_x_-_Raw_data_file_1.0" and have to be ignored.

ConfoCor 2 & 3 LSM Rel 2.x and 3.x

This format is already processed into one that describes the time distance between photons.

The format is explained in Fig. 132. The figure displays the raw data in an editor that shows the raw data in file offset, hexadecimal and as ASCII.

File offset	Hexadecimal	ASCII	
000000	43 61 72 6C 20 5A 65 69 73 73 20 43 6F 6E 66 6F	Carl Zeiss Confo	<ul style="list-style-type: none"> File identifier (incl. channel) Measurement identifier Position (zero based) Kinetics index (zero based) Repetition (zero based) Detector clock frequency (Hz) First pulse distance in detector clocks <p>Raw data start at file offset 80(hex)=128(dec)</p>
000010	43 6F 72 33 20 2D 20 72 61 77 20 64 61 74 61 20	Cor3 - raw data	
000020	66 69 6C 65 20 2D 20 76 65 72 73 69 6F 6E 20 33	file - version 3	
000030	2E 30 30 30 20 2D 20 43 68 61 6E 6E 65 6C 20 31	.000 - Channel 1	
000040	A3 7C 29 64 37 8E BD 41 8A D4 BD 0A EC D2 59 C8	.. d7..A.....Y.	
000050	00 00 00 00 00 00 00 00 00 00 00 00 00 2D 31 01-1.	
000060	00 00 00 00 00 00 00 00 00 00 00 00 00 00 00	
000070	00 00 00 00 00 00 00 00 00 00 00 00 00 00 00	
000080	60 42 03 00 95 34 02 00 91 0A 00 00 C3 24 03 00	"B..4.....\$.	
000090	27 B7 02 00 9D 00 00 00 9A 6F 01 00 41 DC 00 00o..A..	
0000a0	49 6C 00 00 1A 92 01 00 30 C9 0E 00 E7 4F 01 00	Il.....0...O..	
0000b0	10 0D 00 00 FA 1A 00 00 1B BE 00 00 7E 78 00 00~x..	
0000c0	31 E8 00 00 44 6D 00 00 44 96 02 00 73 63 01 00	l...Dm..D...sc..	
0000d0	AD 71 00 00 C1 6E 02 00 E2 3B 00 00 23 96 00 00	.q...n...#...	
0000e0	AF 30 00 00 F3 67 06 00 C5 9D 00 00 70 C4 04 00	.0...g.....p...	
0000f0	76 DB 01 00 E4 32 02 00 27 0F 01 00 79 B6 02 00	v...2...y...	
000100	23 0F 00 00 9F 51 03 00 C6 46 01 00 3A 46 00 00	#...Q...F...F..	
000110	29 59 00 00 97 A6 01 00 DD 33 01 00 D8 A3 05 00)Y.....3.....	
000120	A4 80 01 00 19 1B 01 00 C4 95 03 00 74 CE 02 00t...	

Fig. 132 Rel. 4.x and ZEN raw data format

The first 52 bytes (bytes 1-52) represent the File identifier with the channel number. The identifier is a randomly created number that will be assigned to all repetitions of the same measurement.

The next 16 bytes (bytes 53-68) is the measurement identifier. This will be assigned to all channels of the same repetition. Hence, in a cross-correlation experiment, the two auto-correlation pairs that belong together can be identified.

The next 4 bytes (bytes 69-72) encode the position of the measurement and are zero based.

The next 4 bytes (bytes 73-76) encode the kinetic index and are zero based.

The next 4 bytes (bytes 77-80) encode the repetition number and are zero based.

The next 4 bytes (bytes 81-84) are reserved for comments and set to 0.

The next 4 bytes (bytes 85 -corresponding to a file offset of 5E (hex)=94 (dec)-to 88) code for the first pulse distance in detector clocks.

The next bytes (starting from byte 89) code for follow up pulse distances.

9.13.2 Measure


9.13.2.1 Move Stage During Measure

If the **Move stage during measure** check box is activated, the stage will move during a measurement (Fig. 133).

This option allows you to move the stage forth and back during the entire measurement time. This option is useful during rare event detection when large, slowly moving objects in extremely small concentrations have to be registered. Since these aggregates are diffusing very slowly without such movement the measurement times would be prohibitively long. It should be taken into account that, in this case, the data stream is analyzed with the coincidence analysis rather than by correlation analysis.

If the **Move stage during measure** check box is ticked, the following settings are possible in the dialog:


- Travel distance of the stage in millimeters: Only integer numbers of millimeters are possible. Type into the **Distance x** and **Distance y** display boxes or use the arrowheads.
- Speed of the stage: Only the three preset stage speeds 0.48 mm/s, 4.81 mm/s and 24.01 mm/s are possible. Select 1, 2 or 3 from the **Speed** dialogue box using the pull down menu.
- Travel direction: The stage can be moved along the x- or y-axis of the stage. In this case the value in **Distance x** or **Distance y** are set to 0, respectively.

 Turning points in the stage movement and turbulent medium can cause correlation signals. Watch out for these artifacts.

Piezo Stage

You have the option to mount a Piezo Stage onto your normal stage. Be sure to select on the control unit of the Piezo Stage **the closed loop** operation. If closed loop is selected the corresponding LCD will light up. You have to activate the Piezo XY Stage in the **Config** tool in order to make the Piezo stage available. The Piezo Stage will be used whenever the **Piezo Stage** button is pressed in the **Measure** tool.

 The Piezo stage option is only available with the ConfoCor 2.

 If you haven't chosen the closed loop operation mode, the Piezo Stage will not work properly in the LSM 710 and LSM 780 systems-ConfoCor 3 software.

The Piezo Stage allows for 2D translational motion in the x and y direction with a maximum motion of 100 µm in each direction. The resolution is 1 nm. Positioning accuracy using the Piezo Stage is 10 nm and less.

Movement by the joystick will overrule the Piezo Stage and the normal stage will be addressed.

The position of the Piezo Stage will be centered in respect to the normal stage whenever the **Zero** button was pressed. Zeroing will display 40.000 in x and y in the **Piezo control unit** and are therefore not the same numbers displayed in the Software.

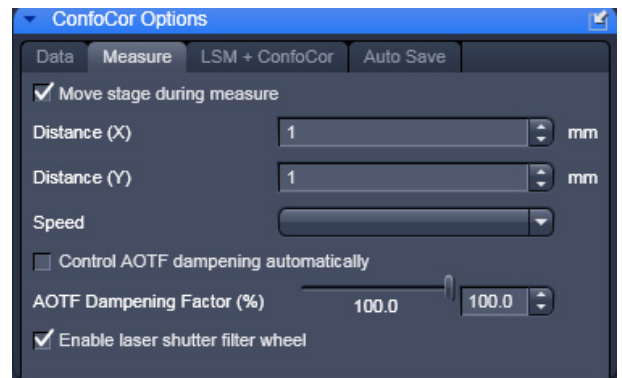




Fig. 133 ConfoCor measure panel

9.13.2.2 Enable Laser Shutter Filter Wheel

If additional shutters (before the HeNe lasers and DSSP lasers and a line suppression filter wheel for the Argon laser) are available in the laser module, they can be activated by checking the **Enable laser shutter filter wheel** check box.

In this case, if the HeNe and DSSP filters are not used, a shutter will be placed in front of them; a line selection filter will be used for the laser line activated for the Argon laser.

 Note, that activating more than two lines of the Argon laser, no line selection filter will be used.

 This function is recommended when measuring close (within 0.2 μm) to the cover slip glass to suppress any residual excitation light.


9.13.2.3 Control AOTF Dampening Automatically


If the **Control AOTF dampening automatically** check box is ticked, the laser AOTF setting will be extended into the lower dynamic range. Please note that in case two activated laser are set at different ranges, the one in the lower range will be set to the lowest available AOTF of the higher range.


If the box is unchecked, the AOTF can be suppressed overall by a certain percentage. By moving the slider of the **AOTF Power (%)** selection box, the respective dampening factor can be set.

9.13.3 LSM + ConfoCor

The **LSM + ConfoCor** function (Fig. 134) can be used to enter offset values between LSM scanners and the X,Y-stage, if the latter is used for FCS measurements. The offset can be determined by bleaching holes into a dye layer and determining the offset between the defined cross lines and actual bleach spots. Type in the corresponding numbers in the **Offset X**, **Offset Y** and **Offset Z** dialogue boxes or use the arrowheads.

 If the scanners are used, offsets due to hysteresis can be corrected with the **Bidirectional** sliders. Numbers will only apply to the XY-stage.

 No z offset exists in the ConfoCor 3 and hence the number in Offset Z should be 0. Z offset is also mechanically corrected in the factory for the ConfoCor 2. So as a rule no z offset correction is needed for the ConfoCor 2 and the **Offset Z** should be set to 0.

 The **Help** text explains, when positive or negative values must be entered in dependence where the bleach spot was observed in relation to the cross line for a ConfoCor system at the side port. Signs will change for a ConfoCor system on the base port (only applicable to ConfoCor 2).

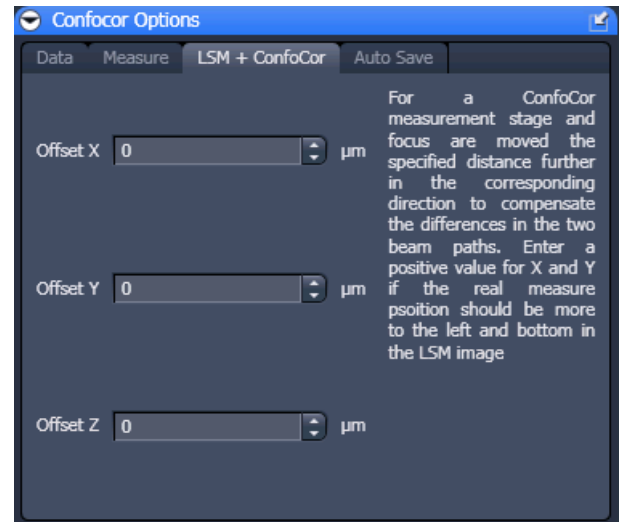


Fig. 134 ConfoCor Options - LSM + ConfoCor

(1) Determination of the offset between LSM Scanner and FCS Stage Positioning

You can compensate manually or by using a Macro (only available for Rel. 2.x and 3.x versions).

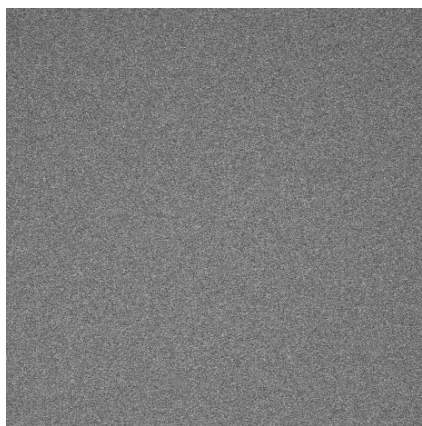


Fig. 135 Image of dye layer

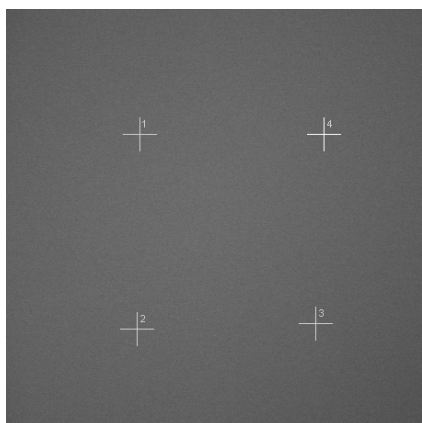


Fig. 136 Image of dye layer with selected positions

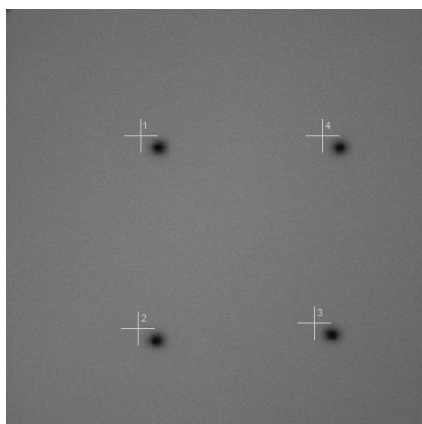



Fig. 137 Image of dye layer after bleach

Manual Adjustment

Do the manual adjustment according to the following procedure:

- Obtain an LSM image of a dried layer of a suitable dye (Fig. 135). Optimize focus position.
-  To obtain the dye layer, dissolve the dye at a concentration of 1 μM in ethanol, cover the bottom of a suitable glass bottom chamber with the dye solution, and let evaporate over night in a laminar hood.
- In the ConfoCor **Measure** tool select **LSM Image** from the **Positions** panel. Mark the points in the LSM image that you want to bleach (Fig. 136).
- Perform a pre-bleach with high laser power for 3 seconds. Close the pinhole to 10 in order to avoid high count rates on the APDs.
- Re-scan the image (Fig. 137). The bleached spots should be visible.

- With the overlay tool (Fig. 138) measure the offsets in the x and y directions between the bleached spots and the cross-lines (Fig. 139). Enter the average values in the **LSM-ConfoCor** menu.
 - If the bleached point is left to the marker: type distance in X as positive value
 - If the bleached point is right to the marker: type distance in X as negative value
 - If the bleached point is below the marker: type distance in Y as positive value
 - If the bleached point is right to the marker: type distance in Y as negative value
 - Offset Z: no entry

Check the correctness of your settings by repeating the adjustment procedure (Fig. 140).

If the deviations between bleached areas and markers are marginal, the LSM / FCS superposition alignment is sufficient to guarantee a precision of 1 μm .


-  Please note, that precision is higher if you decide to make a measurement in one section of the image rather than all over it. In this case only deviations in that sector should be taken into account for calculating the offset values.



Fig. 138 Overlay tool

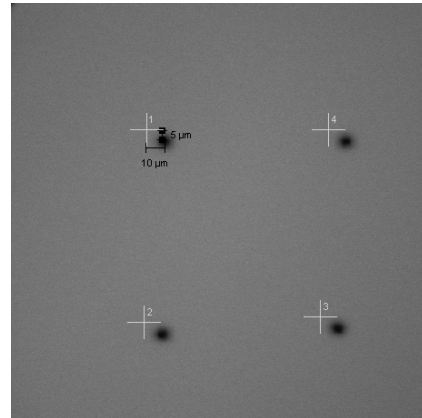


Fig. 139 Image of dye layer with overlay

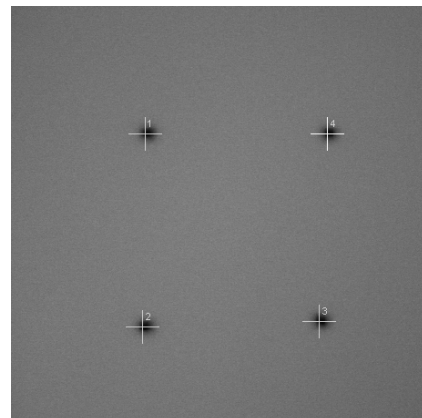


Fig. 140 Image after offset correction

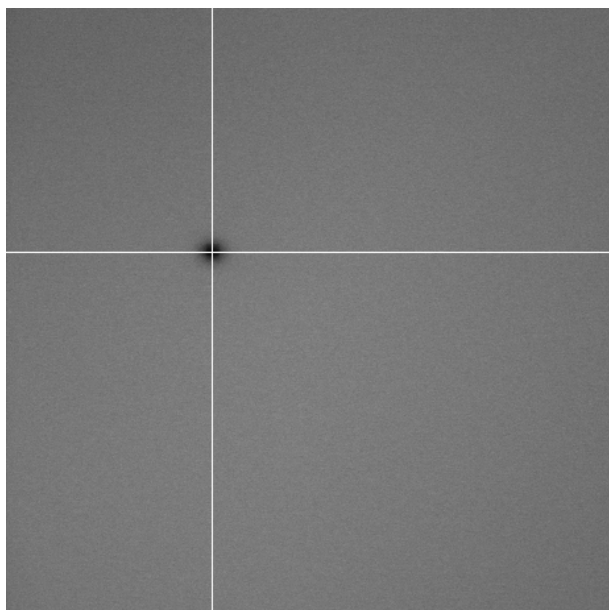


Fig. 141 LSM image after bleaching in the ConfoCor 2 with cross hair positioned; the offset from the optical axis is due to an ioffset between the optical axis of the ConfoCor 2 and the LSM

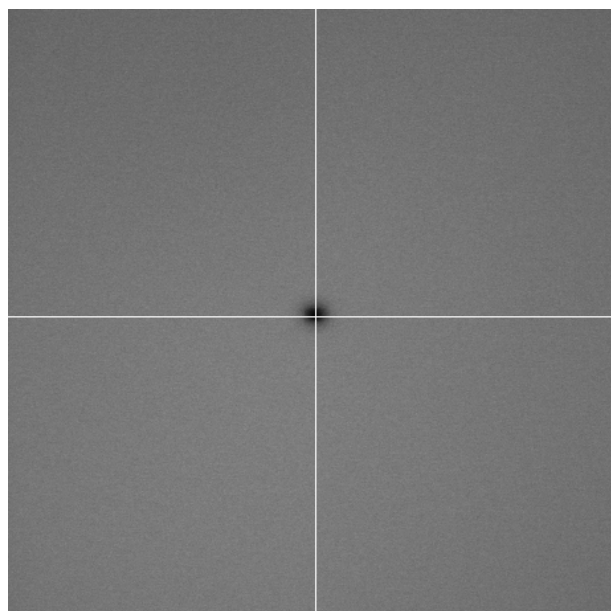


Fig. 142 LSM image after bleaching in the ConfoCor 3 with cross hair positioned; there is no offset between the ConfoCor 3 and the LSM and the bleach is on the optical axis in the center of the image

(2) Determination of the laser beam position in an LSM image

- Obtain an LSM image of a dried layer of a suitable dye. Optimize focus position

☞ To obtain the dye layer, dissolve the dye at a concentration of 1 μM in ethanol, cover the bottom of a suitable glass bottom chamber with the dye solution, and let evaporate over night in a laminar hood.

- In the ConfoCor **Measure** tool select **Current** from the **Positions** panel.
- Perform a pre-bleach with high laser power for 3 seconds. Close the pinhole to 10 in order to avoid high count rates on the APDs.
- Re-scan the image. The bleached spots should be visible (Fig. 141).

☞ The coordinates of a bleached position is only valid for a certain zoom, offset and rotation. Without rotation and offset, the scanners are parked and the bleached spot should be in the middle of an $n \times n$ frame size image for the ConfoCor 3. For ConfoCor 2 on a different port than the LSM, there will be an offset from the middle, depending on the alignment of the two optical axes of the ConfoCor and the LSM.

- Record the position of the spot.
 - With the crosshair. Place crosshair above the bleached spot (Fig. 141). We recommend to use the crosshair for positioning your cell.
 - With the cursor. Make sure that under **Options / LSM Settings** in the **Image Status Display** tab the **Pixel Intensity** box is checked to activate the display of the coordinates. The coordinates will than be displayed at the **Status Area** (Fig. 142).
 - With an overlay arrow. Click **Overlay** and activate the **Arrow** button. Place the arrowhead in the middle of the spot.

- ☞ Normally no compensation in z is necessary. If this should be the case, you need a very thin dye layer. Focus on the maximum by scanning. Then perform a z-Scan by pressing the xyz-Scan action button taking care to have appropriate settings. Compare the peak position with the focus position of the image to obtain the offset.
- ☞ If no position is selected in the ConfoCor 3, the scanners and stage will stay and if no offset, pan or rotation was defined, the bleached spot will be at the center of the image (Fig. 143).
- ☞ If you want to stay at the optical axis, you must position your measurement positions at the position of the laser beam. With no offset of the scan area defined, this will be the center of the image in the ConfoCor 3 (Fig. 144), and an offset position in the ConfoCor 2 (see Fig. 144). Note that the offset coordinates will only be valid if the same zoom and pixel size.

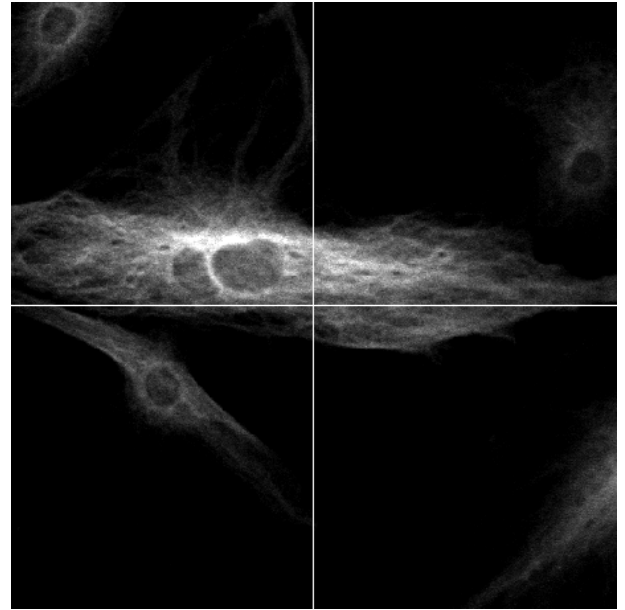


Fig. 143 Manual stage positioning with the ConfoCor 3

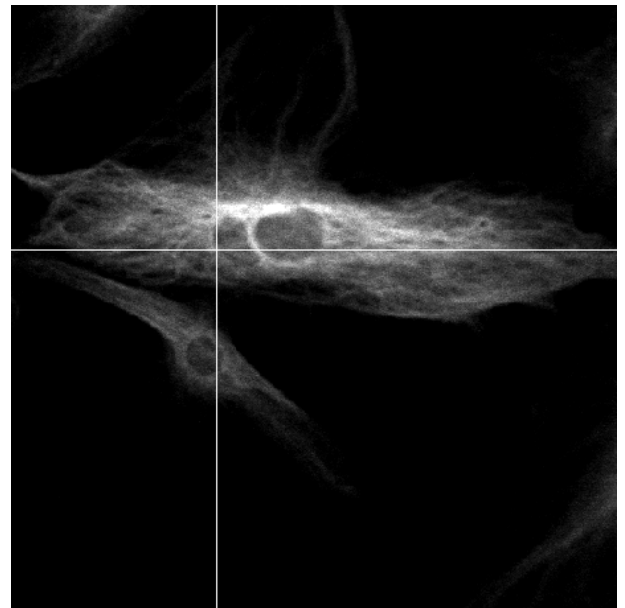


Fig. 144 Manual stage positioning with the ConfoCor 2

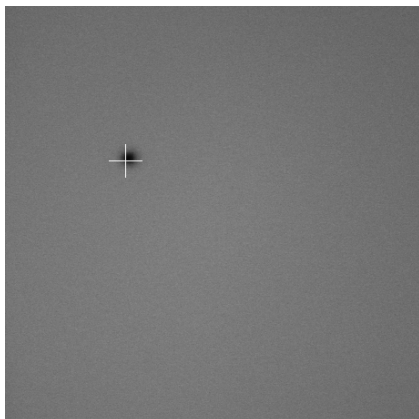


Fig. 145 Scanner positioning before hysteresis correction

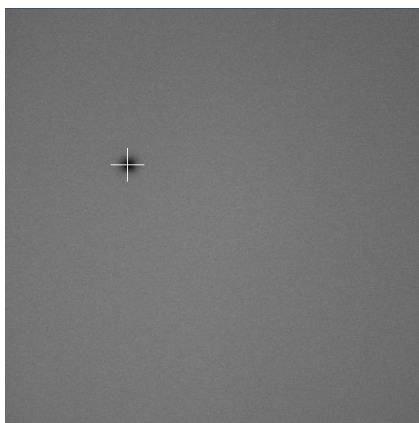


Fig. 146 Scanner positioning after hysteresis correction

Hysteresis correction of Scanning mirrors

In general, there is no need to compensate between defined positions and the actual measurement positions using the scanning mirrors. However, the precise arrest position of the mirrors depends on the used scan zoom and speed and small offsets can occur and offsets may exist due to scanner hysteresis (Fig. 145). To adjust for differences, the compensation sliders of the bidirectional Scan can be adjusted to decrease the offset (Fig. 146).

To compensate for Scan Zoom and Scan Speed go to the **Acquisition Mode** tool of the LSM **Online Acquisition** tool group. Use a sample with high contrast, like "Convolvoria", and focus. Activate **Bidirectional Scan** (double arrow) under **Direction** (Fig. 147). During scanning press the **Auto** button. The system will adjust automatically the **Scan Corr X** and **Y** values. Alternatively you can do the compensation manually.



Fig. 147 Pixel Depth, Scan Direction & Scan Average window

To this end use an edge of a structure or a line. If the **Scan Corr** is not adjusted, you will see a pixel shift (Fig. 148). Alter the **Scan Corr** values to compensate any pixel shift in the following way:

Move the **Scan Corr X** slider until the pixel shift is at the minimum (Fig. 149). Rotate the image by 90° and redo the same adjustment for **Scan Corr Y**.

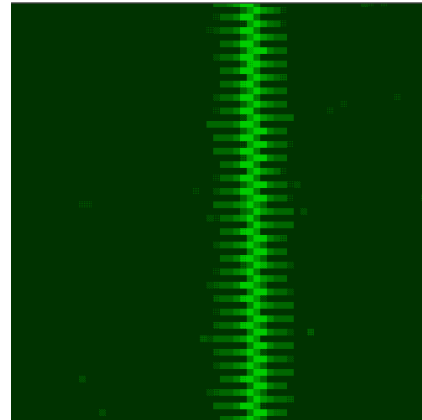


Fig. 148 Image of a line before pixel shift compensation in x

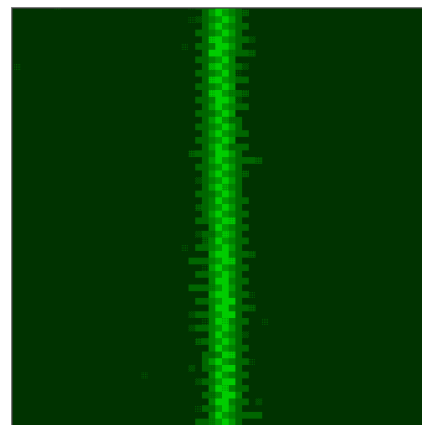


Fig. 149 Image of a line after pixel shift compensation in x

9.13.4 Auto Save

The **Auto Save** panel (Fig. 150) enables you to instruct the program to save the results automatically and continuously during the measurement process. All data recorded until a for example a software failure will be available this way. This function is recommended when performing long measurements. If the **Auto Save** check box is ticked you can specify the directory in the **Directory** selection box, to which the measurement should be saved.

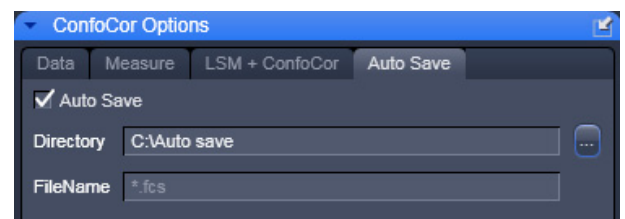




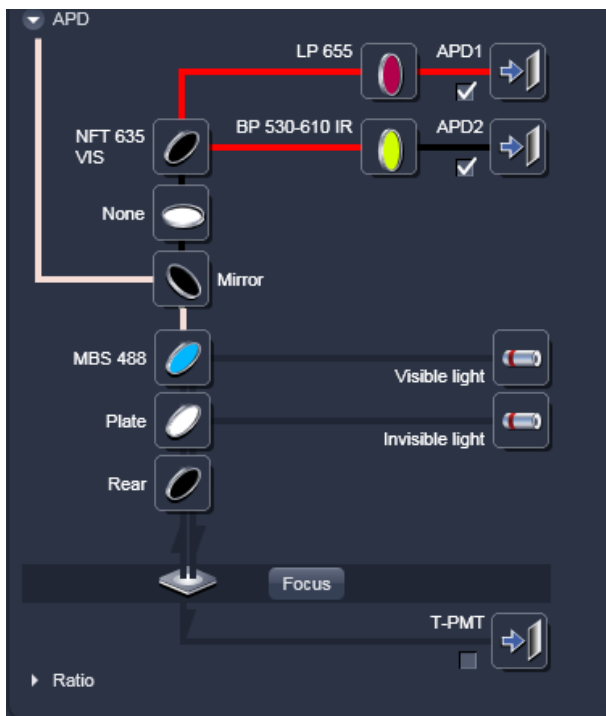
Fig. 150 Option for ConfoCor, Auto Save window

 Only .fcs and hence ANSI format files are saved in this directory. .raw data files are still saved in the directory specified under **Save raw data during measurement**. However, if the **Auto Save** option is active, temporary raw data files will be saved permanently and not only temporarily and will be available if a software failure occurs. The **FileName** entry indicates that .fcs files will be saved. This entry cannot be changed.

9.14 Photon Counting Imaging with the ConfoCor 3

The ConfoCor 3 is equipped with two APD detectors, which can be used as photon counting devices for imaging.

 Care should be taken not to expose the detector to high light intensities. APDs could be destroyed. For this reason, safety shutters will cut off the light at higher exposure levels and detector voltage is shut off. APDs will shut off at 5 MHz. Note that the shutters will stay closed and the user has to restart the scan. You should also avoid to image reflected light and rather use the internal PMTs for finding the coverslip surface by reflection.



9.14.1 Using APD Detectors for Photon Counting Imaging

In the LSM **Light Path** tool APD detectors are displayed as APD 1 and APD 2.

The detectors are selected like normal internal PMTs by activating the check boxes (Fig. 151).


With appropriate dichroic filters APD detectors can be freely combined with the internal PMTs or the Quasar detector.

APD detectors are operated at 20 MHz sampling rate.

However, the software will limit the maximum counts to 4 MHz.

Fig. 151 LSM Light Path for APD detectors

The Pinhole (PH4) can be adjusted in x and y in the **Maintain** register of the Left tool bar area (Fig. 152). Open the **Adjust Pinhole and Collimator** tool and select **PH4** in the Name display box (Fig. 153). Use the same procedure as for normal PMTs. Either trigger an automatic pinhole adjustment or adjust manually by inspecting the intensity from an image. The pinhole should be set at maximum intensity.

 If **Store Pos** is pressed, the current settings will be taken for every image application using channel 4 and the attached ConfoCor 3 module. No realignment is necessary if toggling between Imaging and FCS measurements that might use slightly different Pinhole 4 positions.

In photon counting imaging you do not have electronic gain and offsets, neither is electronic amplifier gain available. Instead a **Digital Offset** and **Digital Gain** sliders are available, which can be used to adjust brightness and contrast of the image during scanning.

In photon counting mode an artificial maximum of detectable photons is set. For APD this value is defined by $CR_{max}/\text{digital gain}$ (CR_{max} = maximal countrate defined by the software, which is 4 MHz for the APD). Note that at a prolonged time over 4 MHz APD detectors will shut off to avoid damage. For example, at gain 1 the maximum count rate is 4 MHz (corresponding to a maximum of 4 detectable photons/ μ s) for APDs. These settings define the dynamic range of the images.

9.14.2 Display of Photon Count Images

There are two ways photon counting images can be displayed in the LSM software, in analog (grey value) or counting (raw data) mode.

You can toggle between the two modes in the **Maintain** area **Options / LSM Options** in the **Hardware** register by deactivating or activating the **Keep raw data for photon count detector** check box (Fig. 154).

If the box is checked, you will obtain the photon counts, if unchecked, grey values corresponding to photon counts.

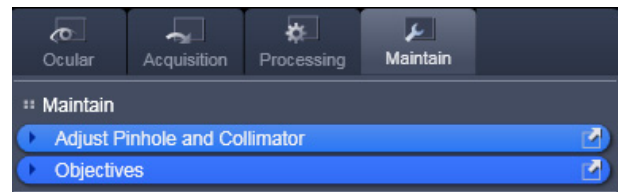


Fig. 152 Left tool area with Maintain selected



Fig. 153 Adjust Pinhole and Collimator tool

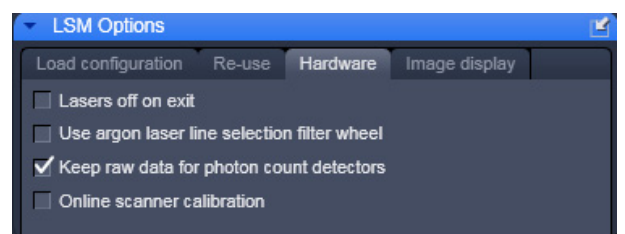


Fig. 154 Hardware register in the LSM Options menu

9.14.2.1 The Analog (Grey Value) Display

In this display, photons are transformed into grey values, which are displayed in discrete intervals in the histograms. Intervals can be calculated by:

$$\text{Interval} = (\text{pixel period} \times \text{frequency}) / (2n-1) = (\text{pixel period} \times \text{CRmax/digital gain}) / (2n-1),$$

where $n = 8$ for an 8 bit image and $n = 12$ for a 12 bit image (see Fig. 155 for an example).

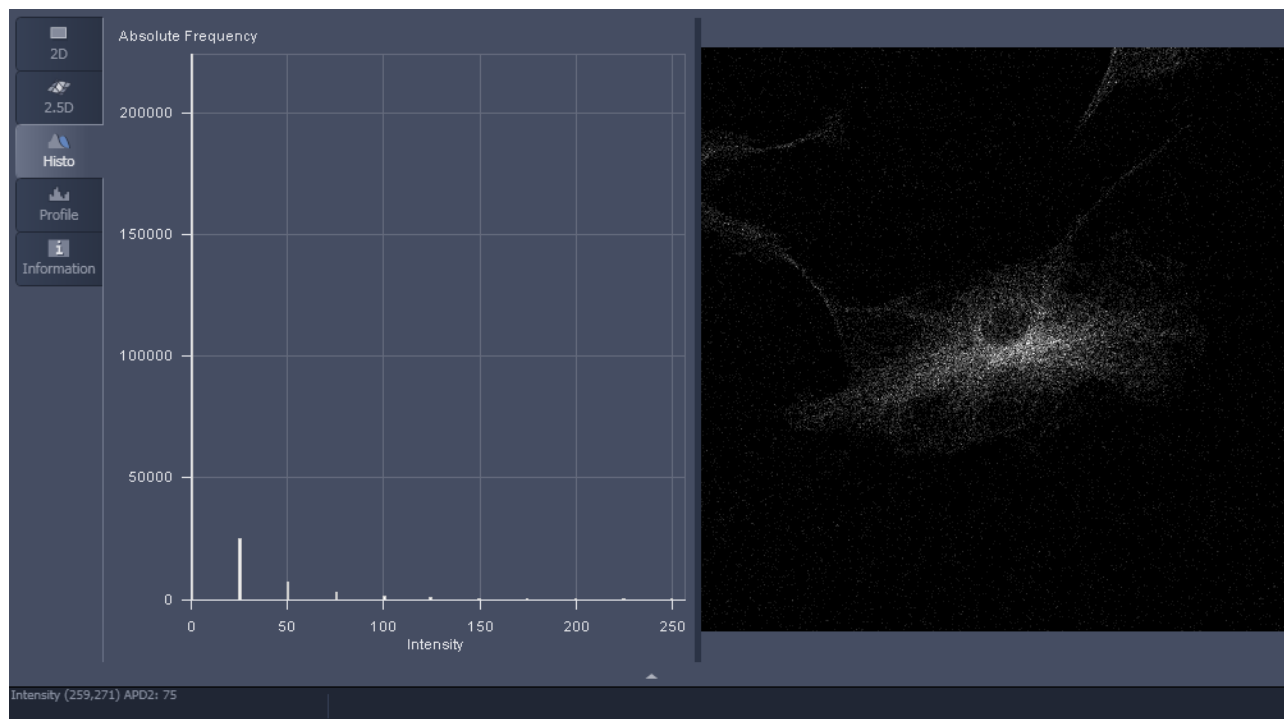


Fig. 155 Analog display in photon counting image. Settings were digital gain 1, scanning speed 8 corresponding to a pixel period or pixel dwelling time 2.56 μs , 8 bit image and APD detectors

Example:

With the APD as the detector, software would limit the maximum count rate to $4 \text{ Mhz} / 1 = 4 \text{ photons} / \mu\text{s}$.


At scanning speed 8 with a pixel dwelling time of 2.56 μs one can obtain a maximum of $4 \times 2.56 = 10.24$ photons. Since photons are integer, this value must be rounded down to 10 photons maximum / pixel.

The spacing interval is calculated for the 8 bit image as $255/10=25.5$. This value is rounded down to the next fifth value, which is 25.

So 1 photon will correspond to a grey value 25, n photons to a grey value $n \times 25$, with a maximum n of 10).

Grey value 0 is reserved for 0 photons, 255 for any overflow. In this way, the histogram is stretched to cover as much as possible of the available grey scale. Therefore, even at lesser or greater photon counts, the image will maintain its brightness.

In the **Status Area** the grey value of the pixel to which the mouse points in the image is displayed. A grey value of 75 would mean $75/25=3$ photons in the example with speed 8.

 Analog images can be used for all further processing in the LSM software like mean of ROI function, statistics etc.

9.14.2.2 Counting (Raw Data) Format

In this display, photons are displayed according to their number (Fig. 156).

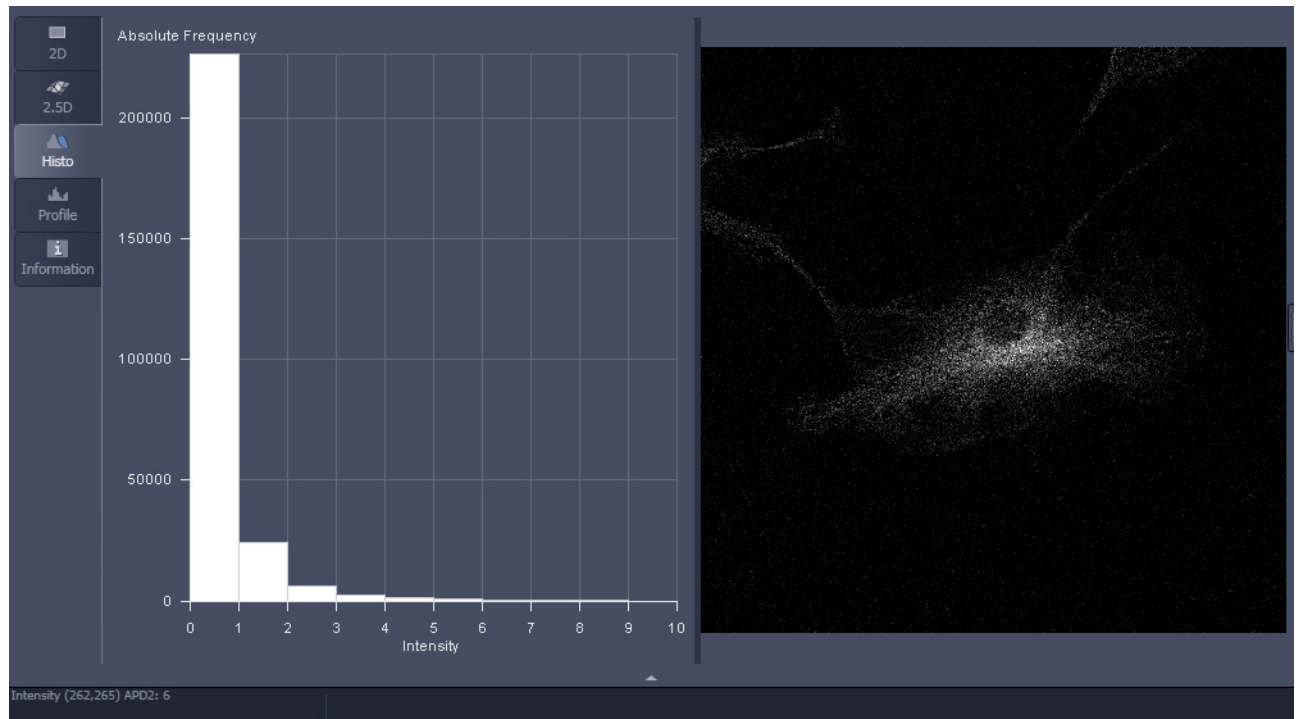




Fig. 156 Counting display in photon counting image. Settings were digital gain 1, scanning speed 8 corresponding to a pixel period or pixel dwelling time 2.56 μ s, 8 bit image and APD detectors

In the **Status Area** the displayed value of the pixel to which the mouse points in the image is displayed as the number of photons.

 Counting images can not be used for further processing in the LSM software like mean of ROI function, statistics etc. They can be exported to have access to the raw data.

 In case of too bright samples, you can extend laser powers to lower ranges by using the AOTFDriverPower45.lvb Macro (Fig. 157). You can set the overall laser power to 100 %, 10 %, 1 % and 0.1 % meaning no reduction or a reduction by a factor of 10, 100 and 100.

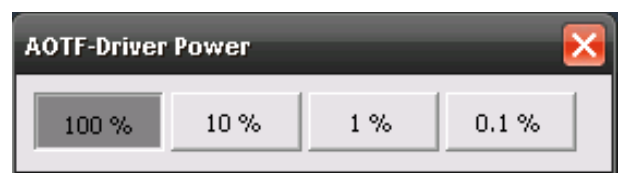


Fig. 157 AOTF-Driver Power switch box

9.15 List of Key Words**A**

Amplitudes.....	55
Anti-bunching terms.....	58
Auto save	133
Automatic Dust Filter	98

B

Beam path.....	22
Bunching terms	60

C

Context menu	93
Correlation function	53
Correlator settings.....	99
Count rate settings.....	99
Counting format	137
Cross-correlation function Definition	54

D

Diffusion terms.....	64
----------------------	----

L

LSM + ConfoCor	127
----------------------	-----

M

Methods.....	13
Model equations.....	54

P

Photon count images.....	134, 135
Photon counting.....	134
Photon counting histogram settings.....	99

R

Reflected-light Observation.....	118
----------------------------------	-----

T

Transmitted-light observation	118
-------------------------------------	-----

Z

Zoom function.....	93, 105
--------------------	---------